

2017 **SVG**

# MOBILE SPORTS PRODUCTION YEARBOOK

THE COMPLETE  
GUIDE TO  
**MOBILE  
PRODUCTION  
SERVICES &  
TECHNOLOGY**

FEATURING THE  
ELEVENTH ANNUAL  
**MOBILE  
SERVICES  
DIRECTORY**



# Play it again SAM.



Snell  
Advanced  
Media

Replay instantly  
with LiveTouch 4K



## LiveTouch 4K from SAM

The only highlights & replay system that truly takes your HD sports workflows into 4K! Includes instant SD/HD/4K editing/production collaboration without copying or moving files.

Find out more:  
[www.s-a-m.com/  
livetouch](http://www.s-a-m.com/livetouch)



SONY

# TO WIN, YOU'VE GOT TO PLAY AS A TEAM.

## Sony's playbook for next-generation broadcasting

Our individual components are recognized all-stars, but they achieve even greater synergy playing as a team. Our cameras capture 16x Super Slow Motion in HD and 8x 4K with full-quality color shading. Our servers record at 10 bits for spectacular HDR and empower a single operator to control up to twelve IP networked instant replay servers. And our switchers and CCUs achieve entirely new connectivity with IP Live. For the best in 4K, High Dynamic Range, High Frame Rate, and IP live production, put Sony on your team.

Meet the team at [sony.com/sports](http://sony.com/sports).



© 2016 Sony Electronics Inc. All rights reserved. Reproduction in whole or in part without written permission is prohibited. Features and specifications are subject to change without notice. Sony and the Sony logo are trademarks of Sony.

4K



# Fast plays deserve a fast network.

Schedule your games in under 90 seconds.

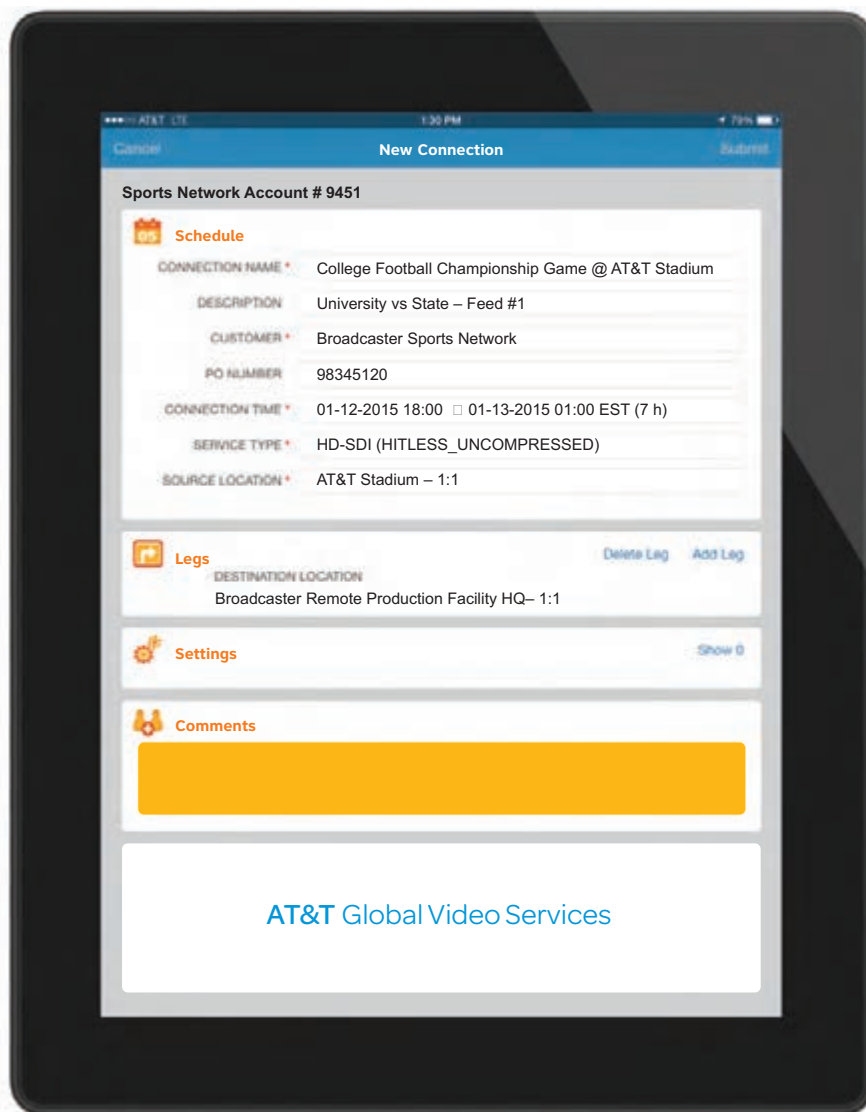

Support for mobile devices, laptops and desktops

- Self Service Provisioning
- Hitless Video Services
- Diverse Routing
- Multi-Media Channel
- Low Latency
- Low Jitter

Contact 800.221.7680 or [ATTGlobalVideo@list.att.com](mailto:ATTGlobalVideo@list.att.com) to learn more!



# The proven choice for sports truck operators

**Vizrt sports productions solutions** are used by the top truck operators and sports broadcasters all over the US. Vizrt's unique set of tools offer a wide range of options for game content with up to 4 channels of **graphics** and **video** in a single box, **vital stats** and **scores in real-time**, an easy tool for moderating social media for instant fan reaction, and analysis tools for highlighting key plays and controversial calls. Truck operators can also be equipped with a portable system for adding augmented reality graphics in the stadium and virtual graphics tied to the field. Using the new **Viz Story**, the key events in any sports match can be instantly shared on social media with custom graphics. Vizrt's one-box solutions for trucks are compact and ready for **HD, 4K, SDI** and **IP** productions.

Learn more at [vizrt.com](http://vizrt.com)





# DATA IN MOTION: FROM THE FOOTBALL FIELD TO THE FAMILY ROOM.

No fumbles, no incomplete passes,  
no unnecessary roughness, no interceptions.  
Western Digital for the touchdown.

**Western  
Digital®**

TALK WITH OUR EXPERTS

Phone Number: 1-800-578-6007

[www.sandisk.com/enterprise](http://www.sandisk.com/enterprise)



PUBLISHED BY  
SPORTS VIDEO GROUP

260 Fifth Ave., Ste. 600  
New York, NY 10001

Tel: 646.205.1810 • Fax: 212.696.1783  
www.sportsvideo.org

**Paul Gallo**, Co-Executive Director  
paul@sportsvideo.org • Tel: 212.696.1799

**Martin Porter**, Co-Executive Director  
marty@sportsvideo.org • Tel: 516.767.6720

**Ken Kerschbaumer**, Co-Executive Director, Editorial  
kenkersch@sportsvideo.org • Tel: 646.205.1810

**Jason Dachman**, Chief Editor  
jason@sportsvideo.org • Tel: 646.861.2373

**Brandon Costa**, Senior Editor  
brandon@sportsvideo.org • Tel: 646.861.2370

**Karen Hogan Ketchum**, Senior Editor  
karen@sportsvideo.org • Tel: 646.559.0434

**Susan Qualtrough**, Copy Editor  
susan@sportsvideo.org

**Riva Danzig**, Art Director  
riva@sportsvideo.org • Tel: 917.602.4588

**Rob Payne**, Managing Director,  
Worldwide Sponsor Development  
rob@sportsvideo.org • Tel: 212.481.8131

**Andrew Gabel**, Manager, Sponsor Development  
agabel@sportsvideo.org • Tel: 646.998.4554

**Greg Baron**, Sponsorship Coordinator  
greg@sportsvideo.org • Tel: 646.559.0435

**Andrew Lippe**, Membership & Client  
Services Manager  
andrew@sportsvideo.org • Tel: 212.481.8133

**Hayley Gordon**, Marketing Coordinator  
hayley@sportsvideo.org • Tel: 646.524.7497

**Cristina Ernst**, Operations Manager  
cris@sportsvideo.org • Tel: 917.309.5174

**Alicia Montanaro**, Conference and  
Organizational Coordinator  
alicia.montanaro@sportsvideo.org • Tel: 646.880.4901

For SVG Europe information  
visit [SVGEurope.org](http://SVGEurope.org)

#### About SVG

The Sports Video Group was formed in 2006 to support the professional community that relies on video, audio, and broadband technologies to produce and distribute sports content. Leagues, owners, teams, players, broadcasters, Webcasters, and consumer-technology providers have joined SVG to learn from each other, turn vision into reality, and implement innovations, while sharing experiences that will lead to advances in sports production/distribution and the overall consumer sports experience.

#### Mission

To advance the creation, production, and distribution of sports content.

To provide a knowledge resource for the growing community of sports video professionals working for broadcast/broadband organizations, professional teams and leagues, collegiate and secondary schools, and facilities.

To facilitate a dialogue with manufacturers, suppliers, and technology developers that will improve the quality and profitability of sports programming.

PRINTED IN THE USA

# 2017 MOBILE SPORTS PRODUCTION YEARBOOK

## LOOKING AHEAD

**11** An Eye to the Future

## EXECUTIVE PERSPECTIVES

**17** Mobile-Production Leaders on State of the Industry and Where It's Headed

## ROAD WARRIORS

**51** 2016 in Review

A look at some of the high-profile events produced around the globe

## 81 NEW TRUCK PROFILES & MOBILE SERVICES PROVIDERS

**86** All Mobile Video

**90** Dome Productions

**94** Game Creek Video

**98** Gearhouse Broadcast

**102** IMS Productions

**106** Mobile TV Group

**110** NEP Broadcasting

**114** Proshow Broadcast

**118** TNDV Television

**122** Token Creek Mobile TV

**126** Viacom Media Networks

**133** 3g Wireless

Aerial Video Systems

AerNow

Alliance Productions

Alpha Video

AV Design Services

Azzurro Group

**138** BeckTV

Bexel Global Broadcast Solutions

Broadcast Services International

Broadcast Sports International

Calhoun Satellite Communications

Calient Technologies

CAT Entertainment Services

**142** CBT Systems

Chesapeake Systems

CineSys-Oceana

Clark Media

CMG Mobile

Communication Engineering Inc.

CP Communications

**146** Creative Mobile Solutions

CSP Mobile Productions

CTG

Digital Comm Link

Diversified

DNA Studios

Duncan Video

DX3 Media

**150** Encompass Digital Media

F&F Productions

Filmwerks International

Fletcher Sports

Gerling & Associates

Illumination Dynamics

Inertia Unlimited

**154** Integrated Media Technologies

Jones Mobile TV

Kaufman Broadcast

KMH Audio-Video Integration

Kodiak Mobile Television

LH Computer Services

Little Bay Broadcast Services

**158** Lyon Video

Markertek

Metrovision

MPS

PRG

Program Productions

PSSI/Strategic TV

**162** Raycom Sports

Reality Check Systems

RoboVision

Rock-It Cargo

Ross Mobile Productions

Saunders Electric

SDTV

Skycam/Cablecam

SMT

**166** sonoVTS

SOS Global Express

The Switch

TL Mobile Television

Unity Systems Integration

VER

## 173 VENDOR SERVICES DIRECTORY

**178** Crew Services

**186** Generators

**204** Mobile Production Units

**228** Satellite Trucks

## 241 MOBILE SPORTS PRODUCTION GEARBASE

Details of equipment found in more than 250 HD and SD trucks

## 286 AD INDEX

Directory of SVG sponsors

# Superior Technology Exceptional Storytelling



SportsCG



Next Gen Stats



Virtual Insertion



Telestration

**Talent Prompter**

Player	Team	Pos	Height	Weight	Age	Exp
JETS	JETS	JETS	JETS	JETS	JETS	JETS
JAGUARS	JAGUARS	JAGUARS	JAGUARS	JAGUARS	JAGUARS	JAGUARS

Talent Prompter

@theACC ACC NETWORK LEADERS TACKLES (per game): 1. Terrance Smith (F)

Ticker

Powered By  
**DMX**



Whatever your game, SMT delivers the complete sports solution for broadcasts, studios or in-venue. SMT's comprehensive suite of cutting-edge products is a producer's dream, from our signature data-driven graphics to our innovative and sophisticated virtual graphics, tracking technology, social media feeds, talent touchscreens and telestration.





WHEN  
EVERY  
**SECOND**  
COUNTS...

## COUNT ON AKAMAI

Don't lose online viewers to a poor experience or high latency.

We're delivering better than broadcast quality video year after year, for the largest live events on the planet.

Why chance it with anyone else when a single second can change an entire experience.

Call us before you go live. 1.877.425.2624

[www.akamai.com](http://www.akamai.com)

 **Akamai**  
FASTER FORWARD

# CALREC

ON AIR  
BROADCAST  
FOR ONLY \$34,500

8 <b>B</b> Brio	26 <b>R</b> Redundancy	103 <b>I</b> Integration	77 <b>O</b> Hydra2 Organiser
-----------------------	------------------------------	--------------------------------	---------------------------------------



13 <b>T</b> Trust	75 <b>H</b> Hydra2	103 <b>I</b> Integration	91 <b>S</b> Salvos	62 <b>Is</b> Inserts	28 <b>Au</b> Automation	86 <b>D</b> Dante	103 <b>I</b> Integration	77 <b>O</b> Hydra2 Organiser
-------------------------	--------------------------	--------------------------------	--------------------------	----------------------------	-------------------------------	-------------------------	--------------------------------	---------------------------------------

**Slogan created by:** *Name: Tim Jacobs Job title: Technical Director*  
*Company: NBC Universal*

Calrec Audio is relied on every single day by the world's most successful broadcasters. Calrec's reputation for build quality, reliability and audio performance has made it an industry standard across the world.

Designed and manufactured in the UK.  
100% broadcast, 100% Calrec. All for just \$34,500.

**Call Calrec on 661 877 9775, or email [brio@calrec.com](mailto:brio@calrec.com)**

LIVE PRODUCTION



# 4K POWER TO THE TRUCK



"Our mobile units represent the gold standard in television production. At the core of these facilities is the always dependable Kayenne K-Frame video production switcher."

Garrett Sullivan, Vice President of Business Development  
Game Creek Video

## Productions change. Your equipment shouldn't.

Set yourself up today with a truck that produces full performance HD and can switch to 4K when you need it to — all from a single, switchable system. Keep your trucks on the road every day with the ultimate flexibility. Only from Grass Valley.

Learn more by visiting [grassvalley.com/4K](http://grassvalley.com/4K)



Live Production



News



Content Delivery



Networking



grass valley  
A BELDEN BRAND

Create Control Connect

Content Your Way.

Copyright © 2016 Grass Valley Canada. All rights reserved.

Specifications subject to change without notice. Belden, Belden Sending All The Right Signals and the Belden logo are trademarks or registered trademarks of Belden Inc. or its affiliated companies in the United States and other jurisdictions.

Grass Valley and Copperhead, Densité, EDIUS, K-Frame, K2 Dyno Universe, K2 Summit, Kaleido, Karrera, Kayenne, LDX 86, NVISION, Telecast Fiber and XCU are trademarks or registered trademarks of Grass Valley, Belden Inc., Grass Valley and other parties may also have trademark rights in other terms used herein.

Quantum®



# CHANGE THE GAME

with High-Performance Workflow Storage



Delivering captivating content is harder than ever. At the forefront of fan engagement, sports production has to push the envelope. OTT, high-resolution content, tighter production schedules, and more delivery options than ever require the most efficient pipeline possible. On the StorNext® 5 platform, you can incorporate change into your planning, leverage rather than react, and turn advancements to your advantage. Quantum can show you how to **CHANGE THE GAME**.

Visit [stornext.com/sports\\_svgyrbk](http://stornext.com/sports_svgyrbk) or call 800-677-6268

## Looking Ahead

# An Eye to the Future

By Ken Kerschbaumer

Sports Video Group, Executive Director, Editorial



The SVG *Mobile Sports Production Yearbook* once again celebrates the year in remote-production-facility design, and, once again, those who produce the images and sounds that make the sports-TV industry a powerhouse have a number of new trucks that offer them more firepower, flexibility, and even comforts than ever before. And all those improvements make clear that, even as the industry heads into an era of UHD and IP-based production, along with some uncertainty as to how these new technologies will coalesce, the leaders in the industry remain confident that the way forward means not looking back.

The opening pages of this Yearbook feature interviews with leading business and technical executives from across the spectrum of mobile-production-facility providers. The common theme is not only listening to client needs for today but also ensuring that new facilities promise clients a chance to go forward as well.

The question now is, when will the clients get there? The biggest question remains when, exactly, UHD production will begin to gain some serious traction. The Canadians are clearly the leaders when it comes to committing to UHD sports production, but, interestingly, Netflix and Amazon are looking to UHD production for such events as concerts and entertainment specials.

The good news is that the UHD transition is actually years, if not decades, ahead of where HD was at this time in its transition. Although we are now in an age of instant thumbs-up/thumbs-down on whether a new format will become a true market force, it is worth remembering that patience will often be rewarded.

For example, all the new trucks lay the groundwork for UHD production. And one cannot fault a broadcast community that is waiting patiently for the tools in the HD production arsenal to be available for UHD needs as well. Topping the list of big hurdles to be cleared are wireless UHD cameras, 4K EVS replay server capabilities for the type of big shows that can typically lead the transition to a new format, and the ability to produce both an HD and a UHD broadcast out of the same truck with the same personnel.

One thing is certain about 2017. It will see plenty of the new trucks deployed to make UHD production a reality. More productions will also experiment with operating a mix of 1080p and 4K cameras. And then, of course, HDR is certain to be a major source of conversation and experimentation: without a doubt, the majority of industry executives believe that HDR is the real game-changer.

As for IP-based remote production facilities? The jury is still very much out on when the industry will make that shift in a comprehensive way. Not only are there issues with respect to manufacturer interoperability (expected to be solved sometime in 2018), but there is still a steep learning curve for engineering teams, as well as some reliability issues (which, in some instances, are related to the learning curve). But there is little doubt that, for UHD production to become widespread, IP-based production facilities will need to become the norm.

As always, the team at SVG will be committed to making sure you will keep up-to-date on all the latest advances in both UHD and IP production. And next year's Yearbook will once again reflect and report on the latest advances in remote-production-facility design. In the meantime, enjoy this great resource to make sure you find the production facility that meets your needs today — and gets you thinking about the future. 

*The Sports Video Group Advisory Board comprises leading industry figures who are committed to technical excellence in the sports industry. Members help guide the direction of the organization, consult on various group initiatives, and enable dialogue across industry segments.*

### CHAIRMAN

**Tom Sahara**, Turner Sports, VP of Operations & Technology

### ADVISORY BOARD MEMBERS

- Ken Aagaard**, CBS Sports, EVP, Innovation and New Technology
- Adam Acone**, NFL Network, Director, Media Operations and Planning
- Glenn Adamo**, Ivanhoe Media and Entertainment, President
- Peter Angell**, Lagardère, SVP
- Andrea Berry**, Industry Consultant
- Onnie Bose**, NFL, VP of Broadcasting
- Chris Calcinari**, ESPN, VP, Event Operations
- Jason Cohen**, HBO Sports Production, VP
- Joe Cohen**, The Switch, President, Sports
- Michael Cohen**, Industry Consultant
- Don Colantonio**, Industry Consultant
- Michael Davies**, Fox Sports, SVP, Technical and Field Operations
- Scott Davis**, CBS Sports, VP of Broadcast Operations
- Jim DeFilippis**, Industry Consultant
- Ed Delaney**, Industry Consultant
- Jed Drake**, SMT, EVP of Emerging Technologies
- David Dukes**, PGA Tour Entertainment, Senior Director, Technical Operations
- Jerry Gepner**, L5 Media Services, Media and Technology Executive
- Scott Gillies**, Red Bull Media House, Head of Technical Production
- Steve Gorsuch**, Industry Consultant
- Mark Haden**, MLB Network, VP, Engineering and IT
- Steve Hellmuth**, NBA, EVP, Operations and Technology
- Ed Holmes**, The Holmes Group, Principal
- Deb Honkus**, NEP Broadcasting, Chairman of the Board
- George Hoover**, NEP Broadcasting, CTO
- Jeff Jacobs**, Viacom Music and Entertainment Group, SVP, Production Planning, Strategies, and Operations
- Robert D. Jordan** CFE, Van Wagner Sports and Entertainment, SVP
- John Kvatek**, University of Central Florida Knights, Senior Associate Athletics Director/External Operations
- John Leland**, PSL International, LLC, Principal
- Louis Libin**, Broad Comm, President
- Jodi Markley**, ESPN, EVP, Content Operations and Creative Services
- Michael Meehan**, NBC Sports, SVP, Operations
- Grant Nodine**, NHL, SVP, Technology
- Ken Norris**, UCLA, Director of Video Operations
- Gary Olson**, GHO Group, Managing Director
- Del Parks**, Sinclair Broadcast Group, SVP and CTO
- Patty Power**, CBS Sports, EVP, Operations and Engineering
- Paul Puccio**, Industry Consultant
- Scott Rinehart**, Fighting Irish Digital Media, Broadcast Technology Program Director
- Larry Rogers**, FirstInTV, President
- Mike Rokosa**, NHRA, Technology Executive
- Bob Ross**, CBS, SVP, East Coast Operations
- Oscar Sanchez**, CONCACAF, Director of Broadcast Operations
- Bruce Shapiro**, ESPN, Remote Operations Specialist
- Jack Simmons**, Fox Sports, SVP, Production
- Don Sperling**, New York Giants Entertainment, VP and Executive Producer
- Jerry Steinberg**, Industry Consultant
- Susan Stone**, MLB Network, SVP, Operations and Engineering
- Patrick Sullivan**, Game Creek Video, President
- Larry Tiscornia**, Major League Soccer, VP, Broadcasting
- Jacob Ullman**, Fox Sports, SVP, Production and Talent Development
- John Ward**, AT&T Entertainment Group, SVP, Content Operations
- Ernie Watts**, Industry Consultant
- Mike Webb**, YES Network, VP, Broadcast Operations
- Jeff Willis**, Industry Consultant
- Dave Zur**, KSE Media Ventures, SVP, Operations and Engineering

# HIGH-PERFORMANCE DELIVERY

## A PROVEN, GLOBAL SOLUTION

For businesses that demand seamless Internet video playback, high-performance websites or far-reaching digital file distribution, our Content Delivery Network (CDN) delivers. It's specially architected into our IP backbone, so we have direct control over security, performance and delivery.



You expect speed and security from your CDN. With Level 3, you get it.

➔ **OWN THE CONTENT DELIVERY EXPERIENCE.**

Learn more: [level3.com](http://level3.com)

\* "Gartner Says 6.4 Billion Connected 'Things' Will Be in Use in 2016, Up 30 Percent from 2015," Gartner (press release), November 10, 2015.

\*Approximate numbers.

**Level(3)**  
COMMUNICATIONS

Connecting and Protecting  
the Networked World<sup>SM</sup>

4K

USA.CANON.COM  
@CanonUSApro



4K Premium  
**UHD DIGISUPER 86**  
UJ86x9.3B 9.3-800mm 1:1.7



4K  
**UHD DIGISUPER 90**  
UJ90x9B 9-810mm 1:2.4

4K UHD xS  
**CJ20ex7.8B**  
7.8-156mm 1:1.8



4K UHD xS  
**CJ12ex4.3B**  
4.3-52mm 1:1.8



4K Premium  
**UHD DIGISUPER 27**  
UJ27x6.5B 6.5-180mm 1:1.5

## UHD READY.

Introducing our technologically-advanced family of 2/3-inch 4K UHD Broadcast Lenses with optical performance that exceeds 4K resolution. Designed in collaboration with leading 4K camera manufacturers, these lenses are critically-engineered to achieve more efficient light transmission, maximize MTF at the center and outer edges of the image (even with the 2X extender), and provide superb high dynamic range. In addition, these UHD lenses deliver even higher HD image performance when used on standard HDTV cameras. Be UHD Ready.





**RCS**

**LONDON | LOS ANGELES**  
realitychecksystems.com



# EUROVISION

**FROM BEIJING TO BARCELONA AND ALL THE NBA CITIES IN BETWEEN, EUROVISION DELIVERS THE EXCITEMENT OF THE NBA TO BASKETBALL FANS AROUND THE WORLD.**



© 2016 NBAE photo by Joe Murphy NBAE/Getty Images All Rights Reserved

OUR GLOBAL HD NETWORK PROVIDES  
FLAWLESS DELIVERY OF CONTENT WITH  
WORLD-CLASS CUSTOMER SERVICE...  
MANAGED RIGHT HERE IN THE U.S.

For more information on what Eurovision can do for you, contact  
Jim Scott  
E-mail: [jim.scott@eurovision.net](mailto:jim.scott@eurovision.net)  
Cell: (973) 650-9577



# The Future of Sport Entertainment Is in Dolby<sup>®</sup>



# Executive Perspectives

## Mobile-Production Leaders on State of the Industry and Where It's Headed

By Jason Dachman

**A**lthough the mobile-production business is booming, truck providers face a host of challenges when it comes to technology and their bottom line. Vendors are being asked to deliver more for less as networks look to trim production costs and explore new “at-home” production workflows on lower-profile shows. In addition, technology continues to evolve at a breakneck pace, forcing mobile-production providers to address the needs of today while preparing for the potential arrival of 4K and HDR. Meanwhile, the rise of IP infrastructure seems inevitable, but truck designers must make difficult decisions because IP standards remain in flux and the technology for a full IP-production ecosystem is likely still a few years away. SVG\* sat down with more than a dozen industry leaders to discuss the current state of the business and, more important, where it's headed. Here are the executives we spoke with:



**Mary Ellen Carlyle**  
SVP/GM,  
Dome Productions



**Craig Farrell**  
President, Alliance  
Productions



**Philip Garvin**  
GM/Founder,  
Mobile TV Group



**Robby Greene**  
President/COO,  
IMS Productions



**George Hoover**  
CTO, NEP



**Mike Johnson**  
Director of  
Engineering,  
Dome Productions



**Tim Lewis**  
President/Founder,  
Proshow Broadcast



**Kevin Moorhouse**  
Managing Director,  
Gearhouse Broadcast



**George Orgera**  
President/CEO,  
F&F Productions

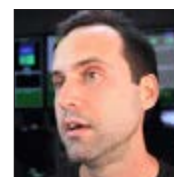

**Mitch Rubenstein**  
President,  
Ross Mobile  
Productions



**Chad Snyder**  
Account Manager/  
GM, Lyon Video



**Pat Sullivan**  
President,  
Game Creek Video



**Jason Taubman**  
VP, Design & New  
Technology,  
Game Creek Video



**Mike Werteen**  
Co-President, U.S.  
Mobile Units,  
NEP



**Peter Wehner**  
Director of  
Engineering,  
Mobile TV Group

\*Responses compiled by Jason Dachman, Brandon Costa, Karen Hogan Ketchum, and Ken Kerschbaumer

[turn to page 22](#)

Custom fly-pack systems  
Managed services  
Modular, production-designed control room systems  
Project management  
Systems design and integration  
24/7/365 global tech support

## Everything you need to create extraordinary Sports Production



VER is your global resource  
for production equipment, support  
and creative solutions



[ver.com](http://ver.com)

# ARE YOU COGNITIVE?



## Automate Your Data Management. Stop Letting It Manage you.

Take control of your data with StrongLINK, the ultimate software-based data and storage management solution:

- Powerful Workflow Integration & Automation
- Global Namespace Connecting Heterogeneous Storage and Applications
- Deep Metadata Extraction
- Seamless Data Migration
- Simple Backup & Data Protection
- Easy-to-Scale Architecture

**STRONG**  **LINK**

Find it. Use it. Share it. Own it.



CELEBRATING 35 YEARS of  
BROADCAST EXCELLENCE



## YOUR MOST VALUABLE PARTNER IN UNPARALLELED PRODUCTION SERVICES



**No other company delivers unparalleled production services like Bexel.**

For more than 35 years, Bexel has supported major broadcasters in bringing the most important events to a global audience. Our team of engineers masterfully delivers the latest in broadcast technologies for a comprehensive range of services including production equipment rentals, systems integration, and new and used product sales.

**24/7 Technical Support, Globally.**

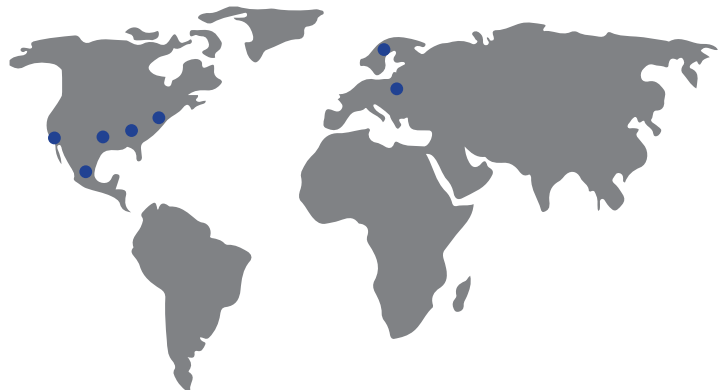

### CONTACT US

[bexel.com](http://bexel.com)

800.225.6185

[services@bexel.com](mailto:services@bexel.com)

# Always take the route of least resistance.



## **DIOS lets you broadcast without boundaries.**

For broadcast professionals incorporating exhaustive audio systems into their business who want to simplify their lengthy efforts for complex network configuration, Studer brings you DIOS. This new network software streamlines audio infrastructure management by automatically searching for the simplest signal

routing between hardware such as interfaces, control surfaces and mixing consoles.

It is the first of its kind to offer a straightforward, intelligent and protocol agnostic support system for end-to-end signal pathways — all within the control network of your own computer hardware.

**STUDER**<sup>®</sup>  
by HARMAN

## Do you consider the current state of the remote-production business healthy? Why?

**Carlyle:** We do. We are in a unique situation because we have different owners [in co-owners Bell Media and Rogers Media] than other mobile businesses [have]. [Sports is] still appointment viewing, so [broadcasters] need facilities to produce those events. The types of facilities may change, but I don't think overall, in the next five years, it's going to drastically change. 4K has also helped us a lot. If we didn't have 4K, we probably wouldn't be launching the trucks as quickly as we [are].

**Sullivan:** I have seen some downward pressure on some of our customers, who are being tasked to do things more efficiently. I think, at the moment, we're in one of those cycles [when] there's a lot of pressure to cut costs on the production side. I think we've been able to [deal effectively with] those issues that are facing our customers and remained healthy in the process.

**Farrell:** There are so many outlets for remote productions right now. Whether productions end up on phones or 4K TVs, they all need efficient multicamera production facilities. That makes a very diverse base of mobile units.

**Garvin:** It seems to be quite healthy and stable. The demand for mobile units seems to be consistent, although there is less growth than we saw a few years ago.

**Werteen:** The industry is healthy, although we need a steady diet of Vitamin C. With audiences becoming fragmented and our clients under cost pressures, you have to focus on maintaining a sustainable business, in addition to supplying quality service.

**Greene:** I consider the state of remote production healthy, perhaps healthier than ever. We look at the growth based on the number of opportunities we discuss with our partners or future partners. We are unable to do a considerable number of events due to lack of availability with our fleet.

**Lewis:** There's definitely continued growth. It's changing, and I think that is unhealthy only if people are not paying attention to industry trends. We see the upper end of the shows getting much bigger and moving into a higher level. Perhaps to accommodate the budget for that, mid-level shows are moving to more-economical production methods like the REMI model, and we're benefiting greatly from that.

**Orgera:** Yes, though we have some concerns. F&F has been fortunate to experience growth this year, [following] the acquisition of Crosscreek in mid 2015. The industry is thriving with so many events covered for broadcast and dramatic growth in large streaming events. However, we have great concerns about the vendors that provide equipment. Their business models have changed significantly, and the proposed restructuring and [providing] services and equipment to remote[-production] vendors will be so costly that it will cripple the industry and stagnate [their] abilities to grow at the rate our clients need and require. It is a huge concern and one that we believe the entire industry should address.

**Rubenstein:** From where Ross Mobile Productions and our many partnerships see it, our evolution to meet their needs has helped keep the remote-production business going strong and healthy. With so many new broadcast outlets, the rising cost of rights fees, the demand for content, and the need to cut costs, there needed to be alternatives to the traditional ways of doing things. Our efficiency model has continued to scale up, and the demand for our services on even larger shows has forced us to keep improving.

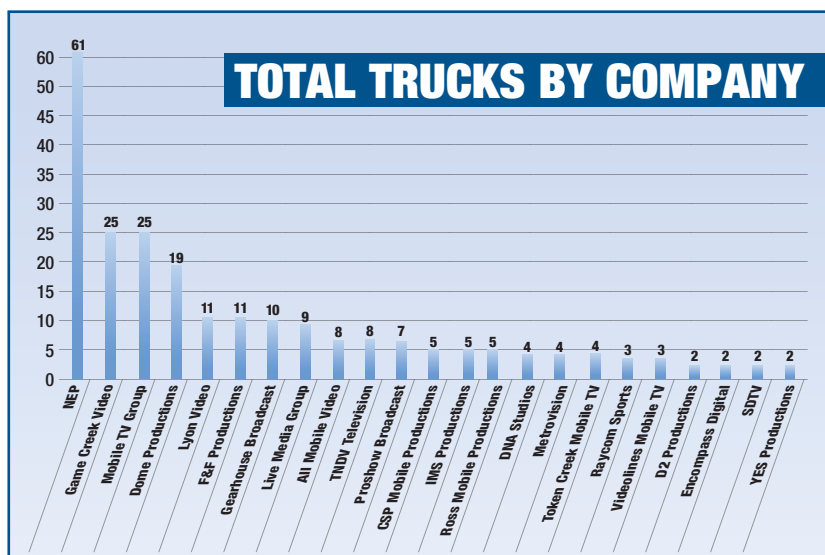

2016 numbers for total trucks broken down by company. Turn to page 241 for full Truck Gearbase Study.

continued on page 26





## Introducing the world's first live production switcher with 12G-SDI for high frame rate production up to 2160p60.

The ATEM 2 M/E Broadcast Studio 4K is a live, multi camera production switcher that features 12G-SDI so you can now work in high frame rate Ultra HD which is perfect for live events such as sports, music concerts, theater and more! The advanced 12G-SDI based design featuring 20 12G-SDI inputs with full re-sync lets ATEM 2 M/E Broadcast Studio 4K work in all HD and Ultra HD formats all the way up to 2160p60! You also get advanced broadcast features such as chroma key, transitions, keyers, multi view and much more!

### High Frame Rate Ultra HD

The native 12G-SDI design lets you use the same high frame rate workflow in Ultra HD for fast action sports that you use in HD! 12G-SDI is 4 times faster than 3G-SDI so it easily handles Ultra HD in frame rates up to 60 fps. Because 12G-SDI switches speeds, you can instantly switch to operate in regular HD whenever you need!

### Creative Transitions

You get a huge range of real time high quality transitions in all resolutions and frame rates! Use mixes, dips, wipes and animated stinger transitions for eye catching live broadcasts! Every transition is instantly available and via macros so you get full control of transition type, pattern, length and other attributes. Create your own 'on air' looks with ATEM's amazing transitions!

### Multi View Monitoring in Ultra HD

ATEM 2 M/E Broadcast Studio 4K features two Ultra HD multi views so you can see your program, preview and sources with custom layouts and labels! For the ultimate in image quality you can use Ultra HD displays or you can use regular HD displays and the multi view will down convert to HD!

### Media Players

The 4 built in media players are designed for high frame rate HD and Ultra HD! ATEM can store full motion video and full resolution RGBA stills with key and fill, or you can direct export from Adobe Photoshop to the switcher with the included plug-in. The media memory is big enough for 64 Ultra HD still graphics plus 360 frames of Ultra HD video or 1440 frames of regular 1080 HD video!

<b>ATEM 2 M/E Broadcast Studio 4K</b> .....	<b>\$5,995</b>
ATEM 2 M/E Production Studio 4K .....	\$3,995
ATEM 1 M/E Production Studio 4K .....	\$2,495

### Get a complete 12G-SDI workflow!

Blackmagic Studio Camera 4K .....	\$2,495
HyperDeck Studio 12G Broadcast Deck .....	\$1,495
Smart Videohub 12G 40x40 Router .....	\$4,995
Teranex Express Standards Converter .....	\$1,395
Teranex Mini 12G Converters .....	\$495



# Conquer your projects without killing your budget.

Adobe Creative Cloud provides everything editors, filmmakers, animators, and designers need to go from script to screen and beyond. Move projects seamlessly through your production pipeline thanks to deep integration between Adobe Premiere Pro CC, Adobe After Effects CC, and Adobe Photoshop CC. Apps that play well together let you fine-tune your edits, audio, grades, and masks in one integrated workflow. Plus add Adobe Stock to access over 60 million world-class images, graphics, videos and our Adobe Stock Premium collection. Because Adobe Stock is integrated into Creative Cloud, you spend more time designing and less time managing your stock assets.



## Adobe Creative Cloud

Learn more at [www.adobe.com/go/enterprise](http://www.adobe.com/go/enterprise)



# The Ultimate 4K Toolbox

## FS4: Offering Unparalleled Workflow Flexibility

FS4 is a four channel 2K/HD/SD or single channel 4K/UltraHD frame synchronizer and up, down, cross-converter. This flagship frame sync and converter delivers incredible versatility and connectivity in a sleek 1RU frame for comprehensive 4K/UltraHD and 2K/HD/SD conversion needs. With a wide range of connection options for both video and audio, FS4 can do the work of four separate devices in 2K/HD/SD or combine all processors and channels together for reliable 4K/UltraHD productivity.



### Single Channel Mode

Bulletproof reliability.  
Incredible conversion power.

FS4 offers incredible connectivity for 4K/ UltraHD workflows with support for Quad 1.5G, Dual 3G, Quad 3G over 3G-SDI and 12Gb/6Gb over optional 12G SFP+ support. Up, down, cross-convert to your heart's content from SD all the way through to 4K. Audio is no slouch either with an incredible 272 x 208 matrix of audio capabilities including MAD, AES and embedded audio channels.



### Four Channel Mode

Multi-channel density in a 1RU Chassis. Space, energy and power possibilities preserved.

In four channel mode FS4 provides incredibly powerful multi-channel conversion with up to four channels of simultaneous processing for 2K/HD and SD signals. Powerful processing allows Region of Interest (ROI) scaling, color correction, processing amplifier controls, motion adaptive deinterlacing and much more.



### 12G/6G HD-BNC and Fiber SFP+ Options

Expand your bandwidth.

FS4's SFP+ options include both 12G/6G-SDI HD-BNC and Fiber I/O options, as well as the choice of 3G-SDI Fiber SFP and CWDM multiple wavelength CWDM SFPs, allowing advanced multiplexing of signals over a single fiber connection.

Choose what you need for great SDI flexibility and fiber cable runs of up to 10 kilometers, all connected directly to the FS4 without the need for separate fiber to SDI conversion.

## **How has the increase in “at-home” or REMI (remote-integration) productions impacted your business and the industry? Do you see this continuing?**

**Lewis:** We’re seeing expansion, and we expect it to grow, which is a good thing for us. We’re building trucks specifically for this market, and we seem to be hitting the mark with our clients on a balance of equipment and agility and cost-effectiveness. They are very pleased with the production quality.

**Garvin:** The demand for at-home production has diminished for us this year. Although it is still in demand for smaller productions, it appears that networks have re-examined the value proposition — especially when factoring in all the capital and personnel costs involved back in the studio.

**Rubenstein:** At-home production represents a shift in how events are traditionally done. If you don’t find a way to fit your business or production model into that new way of doing things, it can have a negative impact. We have made our trucks able to do [at-home] productions as well as traditional. It has also forced us to get even better and more efficient. I see networks continuing to look for the best ways to save on costs while maintaining quality. These trends now have Ross Mobile Productions with a Fort Lauderdale-based studio, four flypacks, and multiple mobile units with high-level at-home or REMI capability.

**Sullivan:** Not much [interest], honestly. The interesting thing about REMI is, audio requirements are not all that different from requirements for regular shows, so, by the time you finish meeting those requirements, you’re almost back into a 53-ft. truck. There have definitely been some cost savings as a result of REMI production, but there hasn’t been a big explosion that makes us think that we should invest in [REMI-focused trucks]. I have seen an increase in requests for flypacks. I think it’s likely that, in the future, we won’t really need a 53-footer with two engineers and a driver and can get by with a Sprinter van that has an engineer who drives it as well.

**Carlyle:** It’s definitely impacting our business. REMI is coming. We found a way to make it work. We’ve reconfigured our older trucks to adapt to REMI very easily. We haven’t done that with our newer trucks, [which] we feel should be on the larger events that aren’t REMI. We have also opened up a control room [that] we’ve given end-to-end REMI service. We had roughly five events last year, and we’ll have 38 this year in that control room where we’re doing both ends: the REMI [onsite] and the control room.

**Greene:** I’m certain all in our space are seeing a greater number of requests for IP-based productions. I see it not only continuing but growing at a steady pace. Each company has a choice: embrace the methods and become [able] to deliver whatever our clients need or refuse to do it and live with the result. I think our philosophy is evident [in the recently launched] Killer Frost, [which is] handling over 100 IP productions for the Pac 12-Networks.

**Farrell:** We believe those at-home-type broadcasts will continue to grow. The good thing is that a truck built to do larger shows can go down to that level. They may not want to all of the time, but it is a good way to fill in the white spaces on the calendar.

**Wertheim:** We believe the trend for at-home productions, in multiple forms, will continue to grow. We are working with multiple clients on these types of productions but only in circumstances where it makes financial sense for these clients and NEP.

**Moorhouse:** There is an increase, and I believe it will have a huge impact on our business. But it’s still only for the second- and third-tier events.

*The increase in demand for at-home-production solutions has spawned trucks like ProShow Broadcast’s Opus, built specifically for the at-home model.*



*continued on page 30*



## Introducing the NewTek IP Series

Imagine the possibilities if your sports production wasn't limited by hardware, and if all of your sources and destinations could communicate. Imagination is reality with the NewTek IP Series, the most complete and configurable SDI/IP live production solution in the industry.

---

Learn more at [newtek.com](http://newtek.com)



Pliant Technologies is a new name,  
but it was 25 years in the making.

## Pliant Technologies, the new professional intercom division of CoachComm.

CoachComm has been the intercom industry leader in the toughest sports and professional venues for over 25 years. Best known for the revolutionary Tempest wireless intercom system that is used in more than 40 countries, Pliant Technologies will continue to lead the industry with its new CrewCom professional wireless intercom system. Visit our web site to learn more about Pliant Technologies and how CrewCom is changing the intercom world.



## CREWCOM

BY PLIANT



# IT'S ON.

The #1 news production platform in the US.

Now for sports.



- CAPTURE + ENCODING
- ASSET MANAGEMENT
- ASSET SHARING
- EDITING ● PLAYOUT
- PUBLISHING ● ARCHIVE

bitcentral 

[BITCENTRAL.COM/CORESPTS](http://BITCENTRAL.COM/CORESPTS) | 949.253.9000 | [SALES@BITCENTRAL.COM](mailto:SALES@BITCENTRAL.COM)

## Do you expect more requests for 4K productions in 2017?

**Carlyle:** Obviously, we've been very focused on the progression of 4K as we build new facilities. We converted our Trillium [mobile unit] to 4K and also built Pioneer as a [purpose-built] 4K truck. We have a very busy 4K business with NHL and the [Toronto] Raptors and Blue Jays; starting in January, all the Raptors home games will be in 4K. We're hoping to go forward with another 4K truck, but that has yet to be decided.

**Garvin:** We have one mobile unit built from the ground up for 4K, plus several that are 4K-ready. Requests for 4K are gradually increasing, but it's still a very limited market. We have also identified several factors which differentiate good 4K from poor 4K and have implemented those in our 4K mobile unit.

**Levine:** We anticipate additional 4K events. We have over a dozen units that are 4K-capable. Our new Denali Yukon will launch 4K-ready with Sony HDC-4300's in mid December. We are excited to work with Sony and the Golf Channel on three-hole coverage at the Sony Open, shot in 4K/HDR. We have a robust upgrade plan for more UHD-capable trucks in 2017.

**Sullivan:** Our Madison truck, [which launched] in the fall for MSG Networks, is 4K-capable. We are also building 4K-capable trucks for MASN and YES Network, and we converted another truck, Glory, to do 4K for U.S. Open golf. I believe there's going to be an increase in demand for 4K, particularly when the issues around HDR get sorted out. I personally think HDR is a must for 4K, and that will really push things forward.

**Orgera:** 4K seems to be a weekly conversation within the industry. We have always designed and built our mobile units with growth in mind. Currently, three of our mobile units can pass 4K, and we have designed a 4K mobile unit and are working with several clients on this build. Should the opportunity present itself to move forward, we can quickly execute our plan.

**Farrell:** We have done a dozen or so 4K shows this year. In most cases, we have been able to use a 3G truck to handle the 4K.

**Greene:** There will be more requests in 2017 than there were in 2016, as was the case this year compared to 2015. We began preparing for this technology several years ago by ensuring our fleet had the ability to adapt when client's needs demanded it.

**Snyder:** Today, about half the Lyon Video fleet is 4K-capable. We have one mobile unit equipped with 4K-capable cameras and another set of 4K cameras available from our shop. As we continue to invest more in coming years, 4K-capable will be a requirement Lyon Video requests from our vendors. UHD will become more prevalent in the next several years. We think HDR may be a more compelling technology depending on the final specification of the live version of HDR.

*Dome Productions' Pioneer truck is among several new 4K-specific mobile units launched in 2016.*



## And how are you preparing your fleet for this rise in 4K — and possibly HDR — requests?

**Hoover:** All of the dozen or so new OBs NEP has built worldwide over the past year are capable of 4K production using IP and/or quad-HD-SDI infrastructure. So moving to 4K is basically turning on the feature. However, HDR is still a work in progress as standards evolve.

**Taubman:** Without knowing it, we started preparing for 4K in 2010 by making sure that our entire fleet going forward was 3G-capable. And we didn't really know what 3G was going to be used for — maybe 60p or 3D. Now we are doing 4K in a quad-linked 3G [model]. So we have a fleet that, with minimal effort, is upgradeable to 4K. In fact, that is what we did with RiverHawk for [MLB Network Showcase] 4K games. By the end of 2016, we'll have three trucks on the road that are [purpose-built] 4K, and anything we do going forward is going to be 4K as well.

**Wehner:** Since we have built the first 4K mobile unit from the ground up, we know more about 4K than almost anyone. We have also done extensive tests of 4K HDR at actual sports venues. We've done this with a 3G infrastructure, but, in the future, we would do it with 12-Gb single coax

*continued on page 34*





# Accelerated File Transfer Solutions

Fast. Secure. Reliable. Every Time!

20 days. 74,545 files. 240 TB of footage.  
FileCatalyst reinvented digital file delivery during the Rio Games.

Moving massive media files fast, securely and efficiently is what FileCatalyst does best, just ask NBC Olympics.

We accelerated the transfer of 240 TB of video footage for their production of the Games in Rio, bringing you moments like #PhelpsFace in near real-time.

HDR, 4K, and 8K? Size doesn't matter when you're dealing with FileCatalyst - the Emmy® Award-winning pioneer of managed file transfer and world-leading accelerated file transfer solution.



[www.FileCatalyst.com](http://www.FileCatalyst.com)

# Get them on their feet

From the front row to the nosebleeds, projection mapping can help energize your fans with captivating pre-game or half-time shows. Broadcast-ready means your content looks just as amazing in person as it does for your fans at home.

Give them something to cheer about with Christie® projection technology and keep them coming back for more.



Learn how Christie can help you deliver the ultimate fan experience.  
Visit [christiedigital.com/svgmapping](http://christiedigital.com/svgmapping)

(Left) System design, installation and integration by Quince Imaging. Photo courtesy of Quince Imaging.  
(Top right) System design, installation and integration by Solotech. Photo courtesy of Maple Leafs Sports Entertainment.  
(Bottom right) System design, provision and installation by Westbury National. Photo courtesy of Westbury National.  
© 2016 Christie Digital Systems USA, Inc. All rights reserved.

**CHRISTIE®**



# Changing the Game

Take your sports production to a whole new dimension

Captivate your viewers with a fully immersive sports experience. From rich Ultra HD/4K content and augmented reality to powerful sports enhancements—Avid end-to-end sports solutions give you the platform to create captivating content from any location and deliver a game-changing viewer experience.

Learn how by contacting your Avid sales representative or local reseller, or visit [Avid.com/sports](https://www.avid.com/sports)



## ***Do you see a legitimate business case for moving to IP today?***

### ***Why or why not?***

**Johnson:** We want to put money into technology where we think we're going to get the longest run. Right now, that probably means investing in IP, except that not all the right solutions are there. IP is the infrastructure of the future, but, right now, we have a majority of SDI and purpose-built hardware. We are going to see a transition to more common hardware and less on the SDI side. There is a big business opportunity there, and it's how we're going to maintain [the industry] going forward.

**Moorhouse:** Currently, there is no end-to-end IP solution that is really viable or cost-effective. Our thought is to wait and see where things go over the next 18-24 months. I don't believe that, at the acquisition end, there is anything to gain from having a totally IP solution, specifically when working in HD or 3G. Unless [clients] get added value from an IP solution, we will not make investments yet.

**Levine:** Our business is based on demand and client requests. Our three powerful IP mobile units were designed and built to meet specific needs where IP was a true benefit. Baseband routing is still very viable for many applications.

**Snyder:** IP has a place in production, but current marketed IP technology can be distracting and expensive in a time when many networks' mantra is "more for less." Many of the current IP-based mobile units will be outdated before the investment in IP pays off.

**Garvin:** At this time, there is no business case for building an IP mobile unit unless it's doing one of the half dozen largest events of the year. The best solution at this time for 4K HDR is 12-Gb single coax, and we believe 12 Gb is critically important for the future.

**Sullivan:** I think you have to think carefully about whether you want to invest in IP. Just doing it for the sake of saying this is an IP truck makes no sense. But, if you have a justification for doing it — like we did on Encore, which was really driven by the demand for monitoring — then yeah. I think, a year from now, virtually [every truck we build] will have an IP core.

## ***Do you believe that a new truck needs to feature IP infrastructure to be future-proof? And do you believe 12-Gbps SDI over coax equipment provides a legitimate alternative to IP?***

**Taubman:** One thing is clear: the current quad 3G SDI [model] for 4K isn't really sustainable. At a minimum, it quarters your existing infrastructure, and that's not going to get the job done at the scale our clients demand. Things are moving along a lot quicker than I expected. However, we haven't settled on a standard. It seems like every vendor still has their own alliance around their products with the NMI, AIMS, ASPEN, and other camps. All those alliances say they will be interoperable with one another, but no one has paved the road that makes that possible. While I see the need for 12G in the short term, especially on smaller shows, I think IP is probably going to win the day there.

**Wehner:** We think a truck-friendly IP infrastructure is several years away and, even then, will not be a requirement for anything but the largest events. We do believe that, someday, all trucks will be IP-based but it will not be on the current IP standards.



*Game Creek Video's Encore mobile unit was among the first trucks to be built around an IP router, due to client Fox Sports' U.S. Open and Super Bowl needs.*

*continued on page 38*

INTELLIGENT  
**NETWORKS FOR ANY FORMAT**

Real-Time Networks for Video, Audio, Data and Communications

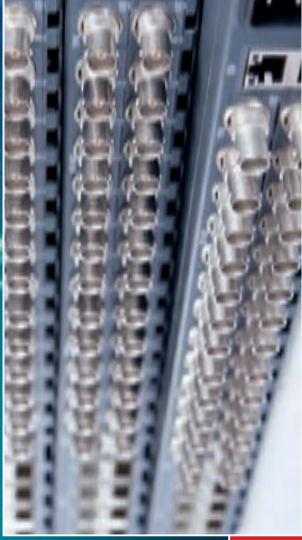

**MEDIORNET MICRON**  
High-density signal interface

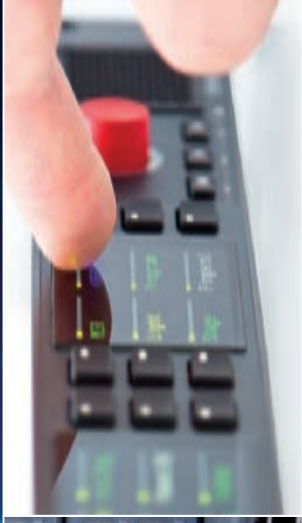

**SMARTPANEL RSP-2318**  
The SMART way to communicate



**TANGO TNG-200**  
Network based intercom application

# PROFESSIONALS RELY ON

THE EXPERT TEAM AT ADORAMA PRO

Your Complete  
Resource For Broadcast  
& Production Solutions



SONY

Canon

Panasonic

convergent  
design

CINEO  
LIGHTING™

dji

FREEFLY

ADORAMA PRO

42 W 18TH ST NYC  
800.223.2500  
adorama.com/pro

For more information  
& pricing visit us at  
adorama.com



# TRANSPORT WITH CONFIDENCE

Introducing InfinityLink — A scalable, reliable, and integrated media transport solution for studio and mobile broadcast sports applications.

Compact 1RU chassis with internal routing and SNMP management

Transporting video, audio, and data over IP and fiber

3G, HD/SD-SDI, DVB-ASI, Ethernet

Low power consumption and noise dissipation

30 years of Artel industry-proven reliability – Made in USA

*Visit [www.artel.com/broadcast-sports](http://www.artel.com/broadcast-sports) to learn about InfinityLink and Artel's media transport solutions for nearly every venue application and budget.*



Simplifying Media Transport®  
978-263-5775 | [www.artel.com](http://www.artel.com)

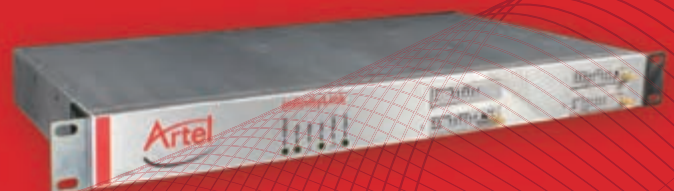

*continued from page 34*

**Snyder:** Several remote-production companies are building baseband mobile units this year. IP is a luxury that only some customers will decide they can afford at this time. We should see an expense-lowering curve in the future because the cost of IP systems will become more reasonable, especially as more equipment manufacturers enter the IP space at a scale that mobile production requires.

**Hoover:** 12 Gbps is just another tool in the connectivity toolbox, along with SDI and IP. We think it has a place in smaller systems.

**Johnson:** IP has the potential to offer more resources and add volume to your capacity — and 4K requires a lot of volume. We are starting by operating with an IP [core], and then, down the road, we're going to see a more fully IP [ecosystem]. It's also very encouraging to see all these manufacturers working together and moving forward with SMPTE 2110 as a standard. But, if I had to [decide] to build a truck tomorrow, I'm still uncertain about IP. On the HD level, I think there may be a serviceable path that you can build with an IP core, but, for 4K, I think, if you chose an IP solution today, you may be wishing you had waited a couple years.

## ***What is the most significant technical challenge in truck design today?***

**Hoover:** As always, it's weight and cooling. We always need to find a few extra thousand pounds in that 8,000-lb. box.

**Snyder:** I think what our customers want the most is reliability. However, the most current technology is not always the most reliable technology.

**Moorhouse:** In the USA, our biggest challenge is getting enough technical fire power whilst keeping vehicle weight under control.

**Taubman:** In the past, we knew really well how to put together a baseband infrastructure, and we knew exactly what that cost. As we move toward IP, I think, you'll see us raising the bar much higher in terms of capacity. But the problem is figuring out the economics, as well as figuring out how to fit it into the truck. For IP, we're still faced with this middle layer of gateways, which add cost and weight and require real estate. We are trying to design a facility so that those gateway pieces can melt away as true IP devices become available.

**Wehner:** It is very challenging to build mobile units that can accommodate the number and types of feeds and sources while maintaining such a high standard of reliability for over 4,000 events annually. Even the most routine regular-season major-league regional game requires many more feeds than we had just a couple of years ago.

## ***Is there a specific technology (or technologies) that more clients are demanding?***

**Johnson:** I think 4K is here to stay, and you will start seeing demand for a lot more 4K trucks. We just need a better toolset so that we can get back to the same level of capacity that we have with HD. We are also starting to see real demand for HDR. Also, high-frame-rate cameras continue to show good momentum.

**Hoover:** High-resolution (4K or greater), high-speed cameras that can seamlessly intercut with standard-speed cameras from an image-quality perspective, as well as replay servers to support them. [Customers are also asking for] seamless high-bandwidth connectivity with the broadcast center.

**Wehner:** Our clients love super-slo-mo systems. So we now have at least two on all our 53-ft. expandos, and all our new trucks have been rolling out with four SSMO [super-slow-motion] cameras.



*The Sony HDC-4300 4K/ high-speed camera has been atop many clients' wishlists, according to mobile-unit execs polled.*

*continued on page 42*





## BETTER TRANSPORT FOR YOUR SPORTS CONTENT

Running transparently on all types of IT infrastructure, the Aspera Transport Platform — including our patented high-speed file transfer technology, our workflow orchestration solution and our new award-winning live streaming capabilities — is redefining sports viewing experiences everywhere.

Aspera is proud to sponsor the Sports Video Group.

Learn more at [asperasoft.com](http://asperasoft.com)



You tell the *story*, **we control equipment**

**News • Studio • MCR**



**A strong, independent company with the industry's largest portfolio of automation products**

- **ASTRA Studio** news production automation
- **ASTRA Take 2** studio automation with multi-camera ingest
- **ASTRA MCR** playout automation
- **ASTRA MAM** media asset management
- **Redwood Studio** industry's first News Studio-in-a-Box
- **Redwood Play** integrated playout solution

**[www.aveco.com](http://www.aveco.com)**



Deliver immersive consumer experiences with a media-optimized infrastructure for content providers and broadcasters.

Succeed with Cisco Cloud Scale Media Experiences.

[cisco.com/go/media](https://cisco.com/go/media)



continued from page 34

**Taubman:** Our clients want to go to 4K, and we want to do it at scale. They want to have all of their cameras be super-slo-mo. I think, if our clients could, they would have all of our HDC-4300's enabled in 8X super-slo-mo and record them that way. But to do that requires this infrastructure that goes well beyond what we're capable of doing today in baseband. All the things they would like to see require extra capacity, which is pushing them in the direction of IP.

**Levine:** As the business continues to change, we look for cost-saving areas that do not affect the overall production. We work closely with clients to implement technology that creates workflow savings — including streamlined tapeless systems, plug-and-play booth kits, connectivity to broadcast centers, and fiber interconnect — to minimize set and strike time.

## ***Outside of technological challenges, what are your biggest concerns facing the industry today?***

**Orgera:** Attracting, acquiring, and retaining great engineering talent to operate all of this constantly changing technology is critical and has always been a huge focus for F&F.

**Rubenstein:** I worry about the next generation of people who will be working in this business — whether it's hiring new staff for us, crewing above and below the line, and sometimes who the next generation of decision-makers will be. As we operate in this new world of change, I hope this trend continues of a willingness to evolve with good ideas that have succeeded for the sake of maintaining a healthy remote-production business.

**Farrell:** As in past years, our largest concern is our external costs: crew and travel are the two largest expenses that push our margins the most.

**Lewis:** It's less of a concern than an opportunity: I think there could be an explosion with Facebook Live that is going to really change things. That's going to [mean] a whole new set of remote-production needs on an incredibly tight budget. Will that be a truck, a flypack, or a Sprinter van? I don't know, but I do think it's going to be a game-changer for this industry.

**Wertheim:** The biggest concern is audience fragmentation. Audiences are insatiable for quality programming, but they want it when they want it, on the device they want to watch it on, at a minimal cost. Many of our clients are still working to find their equilibrium. While this industry evolves, you need to have sound business philosophies, grounded in your beliefs, with an ear to the ground identifying what's around the bend.

**Carlyle:** The big one is finding people for succession. In the production world, nobody's teaching anybody 4K on the production side, so we've become consultants. And also, the whole fear of change is a big drain on our business.

**Garvin:** The one thing that keeps us up at night is climate. The storms that have battered various parts of the nation are limiting the mobility of our trucks. When a governor of a state tells everyone to stay off the highways, shuts down airports, and gives dire warnings, but the sports event is not cancelled, then we still have to get our mobile units to the venues. In the last couple of years, horrible road conditions have been a big threat to our business.

**Moorhouse:** For us, a big one is staff and getting the young talent with the necessary skills to move into this new IP world, because a whole different set of skills are needed.

**Snyder:** Certainly government regulation and escalating rights costs are two major near-term problems that we see affecting the future of remote production today. In the past couple of years, we have seen restraint from some rights holders while negotiating contracts, but, for others, increased amounts of dollars makes sense to move forward. 

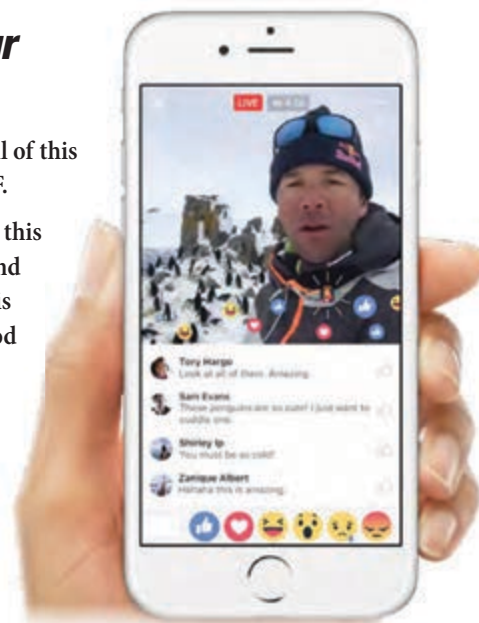

*The exponential growth of Facebook Live shows could potentially create new opportunities for mobile-production vendors.*



Intercom  
Without  
Boundaries



## Adaptable Venue Intercom Solutions

Achieve real-time communications and collaboration with Clear-Com's reliable wired, wireless, IP, and App based intercom solutions for virtually any Sports production.

Communication Anywhere.

Reach us today for powerful solutions in intercom.

# ONE COMPANY ONE GOAL

ChyronHego announced in July that it acquired Sound & Video Creations Inc., a leading developer of digital content management and delivery solutions for sports stadium presentations and broadcasts.

For more than 20 years, **Click Effects solutions have defined digital A/V content delivery** at high-profile live sports and entertainment events. In addition, Click Effects systems have been deployed by hundreds of colleges and universities, by over 75% of Major and Minor League baseball teams, and by nearly 65% of professional football, basketball, and hockey teams. Click Effects solutions are known for their power and reliability in high-pressure live sports and broadcast presentation environments, while also providing cost-effective and operator-friendly capabilities ranging from video playback and replay to data delivery, graphics generation, and audio content delivery.

## A NEW ERA HAS BEGUN.

Click Effects systems deliver scheduled and live video clips, audio tracks, graphics, animations, and sponsor ads that not only entertain audiences, but provide a powerful source of revenue generating opportunities.

To learn how Click Effects solutions can power your in-stadium fan experience, please visit [www.clickeffects.com](http://www.clickeffects.com).



CREATE. MORE.



[www.chyronhego.com](http://www.chyronhego.com)



[facebook.com/chyronhego](https://facebook.com/chyronhego)



[twitter.com/chyronhego](https://twitter.com/chyronhego)



[linkedin.com/company/chyron](https://linkedin.com/company/chyron)

# LYRICX

GRAPHICS CREATION, REINVENTED.

*“To be a true pioneer, you must have first blazed the trail.”*



ChyronHego played a big part in the invention of the character generator.

That's a significant statement backed by a significant history of leadership and innovation.

LyricX is the graphics creation and playout solution you've been waiting for, and it's the solution we've created just for you.

- Create and playout graphics quickly and effortlessly – including in 4K.
- Customize your workspace to suit your workflow.
- Design and animate with ease in LyricX's intuitive interface.
- Customize and take your graphics to the next level with LyricX's powerful API.

**ADD OR UPGRADE TO LYRICX TODAY.**

You can learn more about the incredible benefits of transitioning to LyricX by contacting your ChyronHego Account Director or visit [www.ChyronHego.com](http://www.ChyronHego.com).

CREATE. MORE.





Professional Solutions



## THE STUDIO

Building on B&H's long history of superior service, The Studio is a unique solution-based environment dedicated to all professional market segments.

## TECHNOLOGY CENTER

A revolutionary center created to provide a hands-on experience to high-end professionals. The Technology Center is a fully operational studio with an extensive display of high-end products and state of the art workflows.

## THE TEAM

A highly skilled team of applications specialists, sales engineers, project managers and account representatives, all assembled to create a formidable group of individuals, most of them active members of the professional community.

## SERVICES

- CONSULTATION
- SYSTEM DESIGN
- SYSTEM INTEGRATION
- PRE- & POST-SALES SUPPORT
- TECHNOLOGY DEMOS

420 9th Ave. New York, NY 10001  
212.502.6370  
[BandH.com/thestudio](http://BandH.com/thestudio)  
[thestudio@BandH.com](mailto:thestudio@BandH.com)



Follow The Studio on LinkedIn



Become a fan of The Studio on Facebook



Follow The Studio on Twitter





## Our Clients Play to Win, That's Why They Chose Us.



### Imagine what we can do with your content.

NeuLion powers the highest quality over-the-top video experiences, in up to 4K/Ultra HD, to every device imaginable. Through its end-to-end technology platform, NeuLion specializes in digital video management, distribution and monetization for the world's largest sports and entertainment brands, empowering them to deliver interactive consumer experiences for their viewers worldwide.

# 4K

#### Are you ready for 4K?

Contact us to receive a free  
4K case study!

**Dana Williams**

1.516.622.8301

[dana.williams@neulion.com](mailto:dana.williams@neulion.com)



Follow us, like us, or learn more at [www.neulion.com](http://www.neulion.com)

# Perfecting the Media Experience

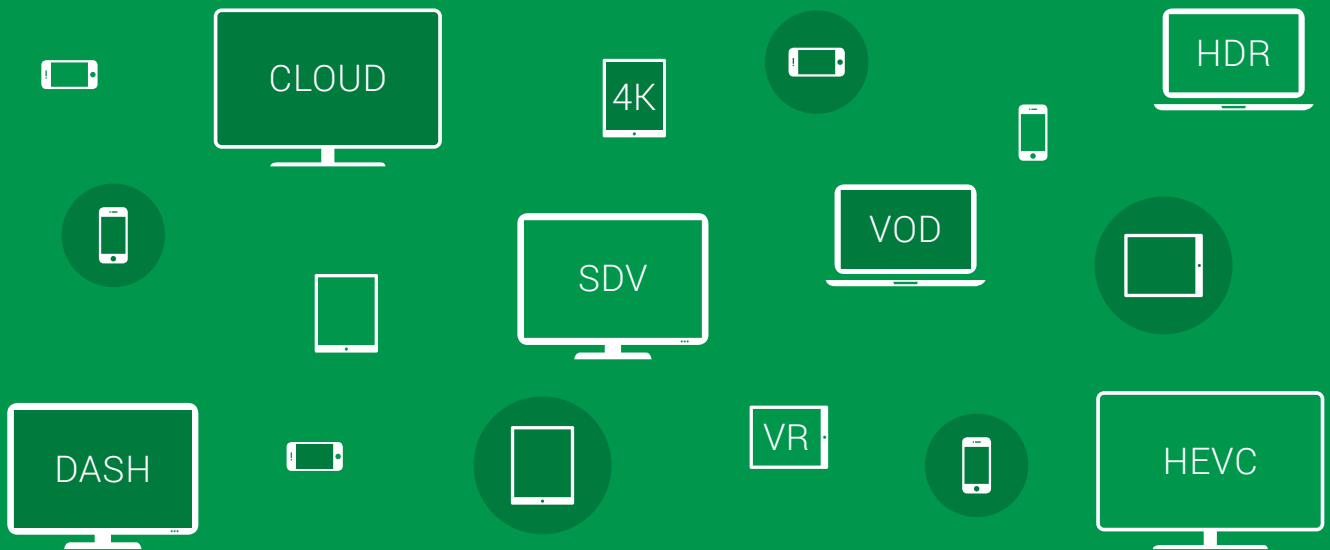

Software-defined video solutions from Elemental empower media companies to deliver premium video experiences to consumers. Pay TV operators, content programmers, broadcasters and enterprise customers around the world rely on Elemental products to quickly and easily scale workflows that deliver video content to any screen, any time – all at once.

# LIVEBOOK GFX

**AWARD-WINNING  
SPORTS GRAPHICS SOLUTION**



## KEY FEATURES

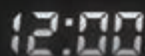

**FLEXIBLE CLOCK CONTROLS**  
OCR, CAMERA DVE & MANUAL CONTROLS



**SCOREBOARD CONTROLLERS SUPPORT**  
DAKTRONICS, OES, WHITEWAY, FAIRPLAY & CUSTOM FEEDS



**STANDARD CONNECTIONS**  
HD/SD SDI, IP-VIDEO,  
TRICASTER NDI  
KEY/FILL & INTERNAL KEYING



**IN-GAME STATISTICS INTEGRATION**  
STAT-CREW, PRESTOSPORTS  
& CUSTOM FEEDS



**NEW**  
**DATA DRIVEN CUSTOM GRAPHICS PLAYOUT**  
LOWER THIRDS, LINEUPS,  
LEADER-BOARDS,  
BRACKETS, PLAYER BIOS, ETC.

## NEW OCR CLOCKS





The game changer is here.  
**XPression.**

[www.xpression.com](http://www.xpression.com)



**ROSS**  
Production Technology Experts

# ROAD WARRIORS

## 2016 IN REVIEW

Throughout North and South America, 2016 was quite the year for sports production. Annual events like the College Football Playoff National Championship Game, Super Bowl, and MLB All-Star Game showed off state-of-the-art technology and enhanced production workflows, and annual tournaments like U.S. Open golf, US Open tennis, and March Madness kept sports viewers tuning in day after day. But the biggest production story of 2016 was undoubtedly the Rio Olympic Games: a record-breaking feat of broadcast production for national- and international-rights holders alike, which captivated audiences around the world. All in all, the live-sports-production community shone in 2016; a trend certain to continue in 2017. Here's a look at some of the highlights from the past year.

### COLLEGE FOOTBALL PLAYOFF NATIONAL CHAMPIONSHIP GAME

UNIVERSITY OF PHOENIX STADIUM, GLENDALE, AZ    JANUARY 11

**E**SPN's coverage of the 2016 College Football Playoff National Championship between the Clemson Tigers and Alabama Crimson Tide represented arguably the most ambitious plan ever for a single football game. First, there was a massive effort to offer top-notch game coverage; moreover, ESPN created 14 channels of additional content available via ESPN3 and WatchESPN.

"I'm proud of my team because the first challenge is dealing with that sheer volume of games and to be able to manage those events, get them on-air successfully, and be ready for two semifinal games and the national championship," said John LaChance, director of remote operations, ESPN. "That's a collective effort that took a lot of planning, and I think the team executed it very well."

Highlights included the debut of Pylon Cam; at each end-zone corner, a pylon housed a camera in each of its four sides and provided comprehensive coverage of the goal line and sidelines near the end zone. The game also featured four I-MOVIX 4K cameras, with two on the far side and two on the near side, and six Sony HDC-4300 cameras with three operating in 6X mode and three operating in 4X mode. There were also two Sony HDC-2500 units operating in 2X mode.

At the center of the game coverage were Game Creek Video's Glory A and B 53-ft. expando units. The equipment complement across game coverage, *GameDay*, Megacast, and ESPN Deportes



*Inside the control room at University of Phoenix Stadium during the game*

included 65 cameras (plus the 32 on the Pylon Cams) outfitted with Canon lenses (five 100X versions, nine 85X, five 86X, and one 75X), 96 channels of EVS XT3 (in various six-, eight-, and 12-channel configurations); and 64 channels of Evertz DreamCatcher. Vizrt and Sportvision gear handled graphics needs, and Calrec audio consoles and Grass Valley production switchers were at the core of mixing audio and video signals.

— Ken Kerschbaumer and Brandon Costa

# C-Next

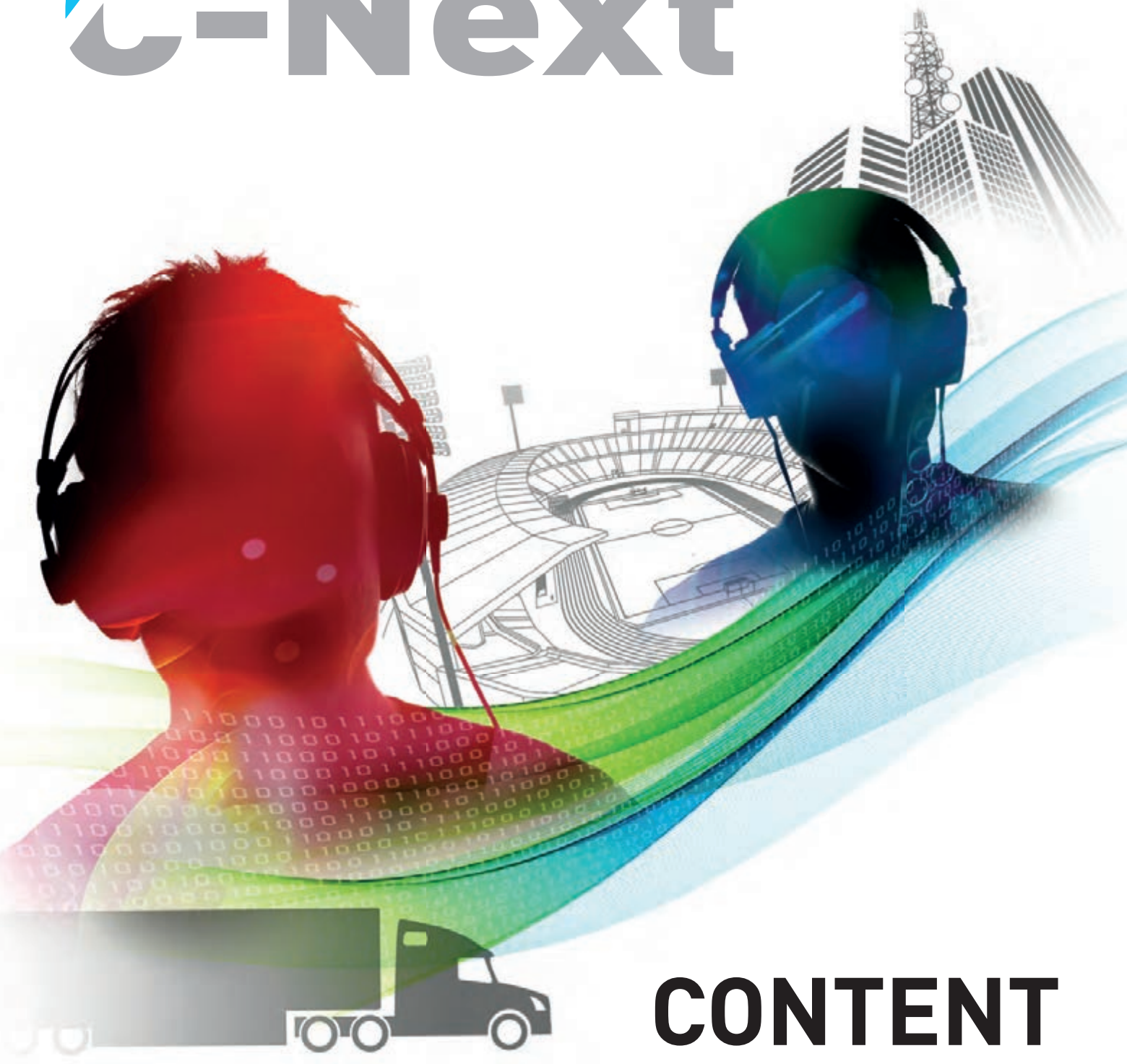

## CONTENT IN CONCERT

The C-Next contribution platform gives your teams in the trucks and at the broadcast center everything they need to access, create, manage and exchange content – in seamless unison.

**SPORTS FROM A DIFFERENT PERSPECTIVE**

**FLETCHER**

**4K UHD HD**

**Ultramotion and Robotic  
Camera Rental Specialists**

**800.635.3824**

**[www.fletch.com](http://www.fletch.com)**

**Fletcher Group LLC**



# Center stage at the world's largest events.

HYBRID IP ROUTING



Platinum™ IP3

HYBRID IP MONITORING



EPIC™ MV

UNCOMPRESSED-OVER-IP TRANSPORT



Selenio™ MCP3

HYBRID IP CONTROL

Magellan™ SDN Orchestrator



Production facilities delivering the world's iconic sports moments rely on Imagine Communications technology to make their businesses more agile, productive and cost efficient.

Robust routers ensure no game-time downtime. Intuitive control enables on-the-fly, on-air reconfiguration. Low-latency multiviewers deliver rock-bottom frame delay. And next-gen tools like HEVC encoding of UHD, live event streaming, J2K remote production and SMPTE 2022 video over IP prepare fast-paced environments for whatever comes next.

**The industry's leading sports production facilities run on our Live Production solutions.**



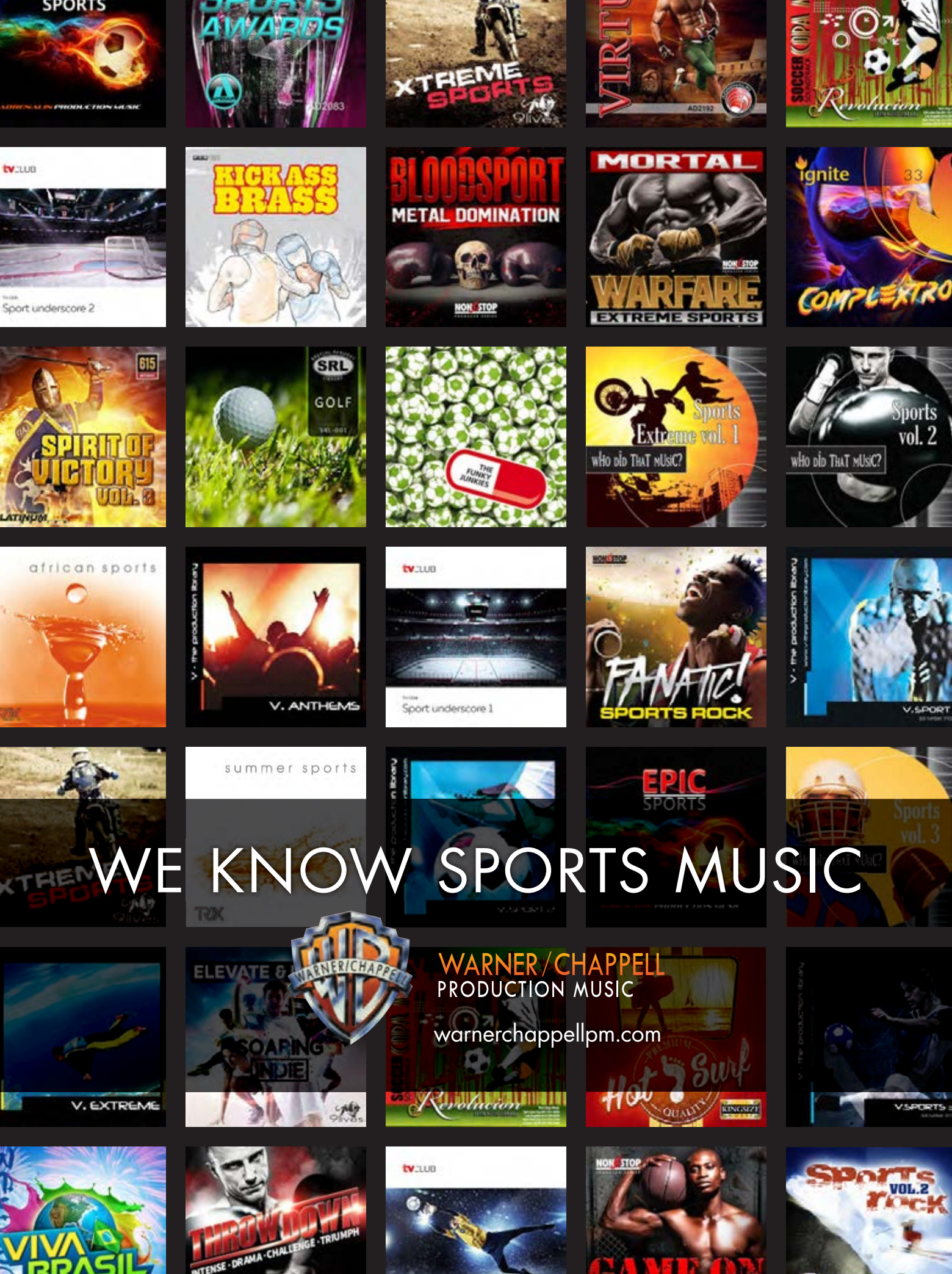

# WE KNOW SPORTS MUSIC



**WARNER/CHAPPELL**  
PRODUCTION MUSIC

[warnerchappellpm.com](http://warnerchappellpm.com)



**SUPER BOWL 50**LEVI'S STADIUM, SANTA CLARA, CA **FEBRUARY 7**

**N**EP's SSCBS, a cutting-edge mobile unit that serves as the backbone of the *Thursday Night Football* production, brought Super Bowl production into the IP era, thanks to an Evertz IP router and plenty of hard work to ensure that operating in IP mode is as reliable as working in traditional baseband mode.

"The good news is that we basically produced a Super Bowl-in-a-Box every Thursday night during the regular season out

of SSCBS. So this is a really good situation for us," said Ken Aagaard, EVP, innovation and new technology, CBS Sports. "We planned, when we knew that we were going to have a new truck, to make sure that it wasn't going to be new and out of the box for the Super Bowl."

The NEP presence at Super Bowl 50 extended beyond SSCBS. Fans around the world saw a world feed produced out of EN1, the halftime show was produced in NEP's Denali California unit, the NFL Honors program was produced out of Denali Summit, and SS16 was at Super Bowl City in San Francisco. NEP also supported ESPN's effort at Marina Green in San Francisco. The truck vendor had 75 employees on hand to ensure that all operations went as smoothly as possible.

During the Big Game, CBS Sports made use of a new Sony 4K camera that can record at 8X speed (coupled with a new Canon UHD lens) and the Replay Technologies' freeD technology, the backbone of CBS Sports' EyeVision 360 system. — KK

*Deployed for CBS's NFL regular-season coverage, NEP's SSCBS truck brought IP production to the Super Bowl.*

**NBA ALL-STAR GAME**

AIR CANADA CENTRE, TORONTO

**FEBRUARY 14**

**N**BA All-Star Weekend, one of the marquee events on the NBA calendar, traveled to Toronto, and the full slate of events once again had Turner Sports and NBA TV production teams, numbering more than 170 people, quite busy. It also marked a return to normalcy after last year's event in New York City, when the NBA All-Star Game was played at Madison Square Garden and All-Star Saturday Night activities were held at Barclays Center in Brooklyn. All the top activities this year took place at Air Canada Centre (ACC).

"Managing one building's schedule is far less difficult than trying to manage two buildings, two schedules, and the logistics of getting back and forth," noted Chris Brown, director, technical operations, Turner Sports.

From a production standpoint, 36 cameras were deployed at the ACC for All-Star Weekend on Saturday night and Sunday. New this year were four Sony HDC-4300 cameras operating in 6X mode for slow-motion replays, and Turner also made use of the freeD 360 replay system.

In terms of the production trailers onsite, NEP's SS24 handled game duties on Friday and Sunday at the ACC, and NCPX was in action for All-Star Saturday Night. A production team working in NCPVIII oversaw halftime entertainment and player introductions on Sunday. NEP's ND1 three-trailer unit was also onsite. — KK



*Turner Sports and NBA TV deployed 36 cameras for All-Star Weekend festivities.*

# DELIVERING THE **4K HDR** EXPERIENCE



## *DreamCatcher*

The demand for UHDTV (4K) continues to grow in the industry and with the addition of High Dynamic Range (HDR), High Frame Rate (HFR) and Wide Color Gamut (WCG) the end user experience becomes highly immersive. Evertz prepares customers for UHDTV with products like DreamCatcher, the platform of choice for 4K HDR replay; OvertureRT LIVE for 4K HDR playout; and 3482TXE-HEVC for 4K distribution.

**evertz**



# Live Stadium Captioning



## Is iCap™ Running in Your Stadium?



Your Stadium + Thousands of Live Captioners

Learn More at [eegent.com](http://eegent.com)

# MultiDyne

## Field Fiber Optic Solutions

The **BullDog™** Field Fiber Transport System becomes your ultra-compact portable broadcast infrastructure.



- AC, battery, and remote power via SMPTE
- Scalable & flexible “building block design” of any I/O compliment.
- Optional monitor and test generator
- Rugged shipping/field case available

Base Station                      Camera Unit

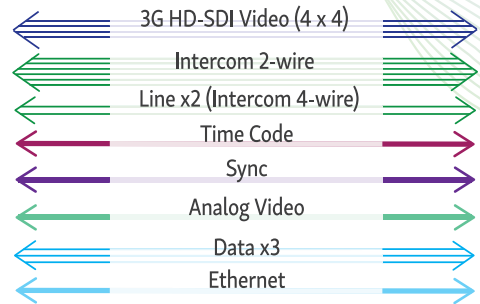

## Fiber Optic Transport cards for openGear... The OG-3600 Series



Base Station                      Camera Unit

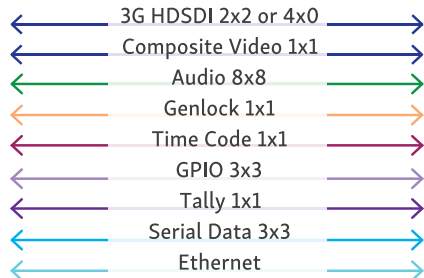

This openGear card platform provides flexibility for ALL fiber transport needs. Signals are transported uncompressed and unprocessed for maximum signal integrity, with support for 3Gb/s, HD-SDI, audio, data, intercom, Ethernet, and reference. The OG-3600 Series is compatible with the industry-standard openGear platform, and offers SNMP management via built-in Dashboard software.

[www.MultiDyne.com](http://www.MultiDyne.com)

**MultiDyne**  
Video & Fiber Optic Systems

Call MultiDyne for more information: 1-800-488-8378 • 1-516-671-7278  
email: [sales@multidyne.com](mailto:sales@multidyne.com)

**FIBER FIRST**

**DAYTONA 500**

DAYTONA INTERNATIONAL  
SPEEDWAY, DAYTONA, FL  
FEBRUARY 21

This year's Daytona 500 marked the completion of the \$400 million Daytona Rising redevelopment project, and Fox Sports pushed the envelope at the 2016 race. Among the innovations, an augmented-reality view of a virtual racecar was generated from the "Hollywood Hotel," the suite of Game Creek FX production units that has been involved with this show for nine years.

Inertia Unlimited's Gophercam (aka the Ground Cam) returned for its eighth season of Fox's NASCAR coverage with a new lens, a lower profile, and new track positions. Two Inertia Unlimited Phantom Flex4K cameras, capable of up to 1,000 fps and allowing tight slow-motion shots, were located on the front stretch and the beginning of the back stretch.

"These cameras will be able to replay and zoom into the action now as a high-frame-rate camera," said Mike Davies, SVP, field and technical operations, Fox Sports. "With one camera, we can

*Fox Sports scattered a wide variety of cameras around the track.*

now break down a wreck in multiple ways using a single camera shot: zoom into the car that caused the wreck, the car that got caught up in it, and the one that got away."

In all, Fox Sports deployed 20 manned cameras; four in-track ground cameras; two Inertia Unlimited X-Mo units (one at the end of pit road, the other at the start/finish line); a 33-ft. tower cam; two grass cams; 10 robotic race cameras; three robotic Hollywood Hotel cameras; eight in-car packages, each featuring three camera angles; four wireless roving pit/garage units; and 25 digital-video-replay devices with more than 110 channels of recording/payout. — *Dan Daley*

**NCAA MEN'S BASKETBALL  
FINAL FOUR**

NRG STADIUM, HOUSTON  
APRIL 2-4

Turner Sports and CBS Sports' joint production of the NCAA Division I Men's Basketball Championship got even bigger this year. The continued growth of the main production, coupled with the TeamStream productions offering fans more-customized coverage of their favorite team, had the



production and operations teams onsite putting on not just three shows over Final Four weekend but nine.

And, for the first time, the entire Final Four, including the Championship Game, moved to cable television, giving Turner Sports its first crowning of a champion ever.

"As someone who has been around sports for some time, these are the moments you live for," said Tom Sahara, VP, operations and technology, Turner Sports. "To say that you're among the first to do it, this will certainly go down as one of the high points of my career."

Turner Sports and CBS Sports lined up 13 mobile production units — six from F&F Productions, six from NEP Broadcasting, one from Bexel — outside NRG Stadium in Houston to support a robust production that included three simultaneous linear productions.

A large complement of 51 total cameras was deployed: 26 working the primary game, eight for TeamStream coverage, and 17 for two studio sets positioned behind each student section. On the specialty end were the Skycam Wildcat aerial system that worked Super Bowl 50 for CBS Sports, an RF Steadicam, the rail cam, a helicopter outside the building, and a collection of Sony HDC-4300 high-speed cameras. — *BC*

*Turner Sports and CBS Sports provided game coverage plus customized TeamStream productions.*

# IT'S A NEW DAY

With our new robotic camera systems, your favorite camera operator can be on or off-site, potentially even at their own house.

- Easy setup
- Familiar hard camera controls
- The same camera as always
- No compromise in quality
- NO CREW TRAVEL COSTS



**INERTIA  
UNLIMITED**

SPECIALTY CAMERAS

[inertiaunlimited.com](http://inertiaunlimited.com)

**802-368-2591**

# Stream. Transcode. Automate.

For broadcasters, media professionals and you



## Telestream Solutions on premises or in the cloud

- Live and on-demand streaming
- Live event streaming production
- Transcoding & workflow automation
- Automated QC & correction
- Captioning

Learn More:  
Visit [www.telestream.net](http://www.telestream.net)

  
**telestream**





SkyCam WildCat represents the Worlds' best in engineering, automation, and broadcast technology, creating an advanced and flexible aerial camera system.

The 4 axis stabilized WildCat system delivers amazing stabilization and image quality, while its open architecture allows for many different payload options to be flown safely in the space the system spans.

INTRODUCING THE ALL-NEW

# SKYCAM WILDCAT

630 NORTH FREEWAY, SUITE 350, FORT WORTH, TEXAS 76102  
817.984.6840

## COPA AMERICA CENTENARIO

JUNE 3-26

**C**opa America international soccer tournament took place in 10 cities across the U.S., with 16 teams playing 32 matches throughout June. CONCACAF inked deals with a number of companies to help ensure that match coverage was all it needed to be, including Broadcast Services Group, HBS, Lyon Video, The Switch, Vista Worldlink, and Zero Fractal. In addition, Atlanta-based Encompass played a key role as the home to the CONCACAF Broadcast Operations Center (BOC).

“This is historic and the biggest soccer event that has happened in the U.S. since the World Cup in 1994, as it has big



stars, great teams, and great attendance,” said Oscar Sanchez, director of broadcast operations, CONCACAF. “We’re trying to have the production at a level that matches that.”

Basic coverage for all 32 matches was provided by 27 cameras, with aerial coverage via helicopters added for the opening match on June 3, the two semifinals, and the final match on June 26 at MetLife Stadium in New Jersey. The 27 cameras comprised 11 hard cameras plus a Skycam, two ultra-slow-motion cameras, four super-slo-mo cameras, a tactical remote camera, two RF Steadicams, two additional handheld cameras, two box cameras, and two net cameras. Lyon Video provided remote-production facilities, with eight HD trucks deployed for the 32 matches. A distribution plan for each match involved a fiber path from each venue (along with two satellite signals) to the BOC.

A highlight of the coverage was a 4K production of the final match. The 4K coverage was a side-by-side production featuring 10 4K cameras, with two camera positions, cameras 3 and 4, directed by the HD match director.

— KK

*Fox Sports offered 4K coverage of the final match.*

## U.S. OPEN

OAKMONT COUNTRY CLUB,  
OAKMONT, PA

JUNE 16-19

**F**ox Sports officially teed up Year 2 of its U.S. Open coverage, and a wet and soggy start to the event didn’t dampen the spirits of a production team charged with delivering golf to fans across the U.S.

“I’m extremely happy with how everything went,” said Brad Cheney, director, engineering and technical operations, Fox Sports. “You plan for it to go a certain way, and we expected to get through the first round. But the storms came in earlier than we thought, and they just kept coming. But the team did an amazing job getting on-air, and the production team did the rain dance for hours upon hours.”

Year 2 of any event incorporates plenty of changes: the team has a chance to reflect on what worked and what didn’t. Among last year’s enhancements that were back and improved were the ProTracer systems, microphones in the holes, and the Hawk-Eye green-shading system. Only two enhancements did not return: the live drone (impossible given the course layout and FAA regulations but used for prerecorded pieces) and the RC Car camera.



*Fox Sports brought back several enhancements from last year, including ProTracer and Hawk-Eye.*

Several Game Creek production units were onsite. Encore handled the core coverage. Pride provided support. Glory handled 4K and featured-hole coverage (the 4K coverage was available via DirecTV), and Edit 2 supported postproduction, with systems provided by CMSI. Caterpillar supplied a UPS for power, and Bexel’s BBS1 was on hand for iso audio. BSI managed the RF cameras, and Fletcher provided robotic cameras around the course. — KK

# ALDEA



*For the 2016 Rio Summer Games, Aldea crafted a tailor-made solution which not only delivered a high-quality, robust, low-latency distribution platform across DIRECTV Latin America's network of production and broadcast centers, but also managed to exceed our expectations in implementation and efficiency.*

*Daryl Van Leuven  
Technical Manager, Sports Programming  
DIRECTV*



For over 15 years, Aldea has been providing high-quality video services and solutions for the television and media industries.

Aldea offers a full-range of sports distribution, event, full-time & occasional use services including HD & 4K transmissions, data connectivity, as well as live streaming for second screen interactive applications.

+1-514-461-4136

| [info@aldea.tv](mailto:info@aldea.tv)

| [aldea.tv](http://aldea.tv)



# YOUR CONTENT. DELIVERED.

When every second counts, a seamless video solution is the only game plan.

- ✔ Satellite Truck Services
- ✔ C/Ku-Band Flyaways
- ✔ Encoding Services
- ✔ Live Event Streaming
- ✔ Disaster Recovery
- ✔ Global Transmission Solutions
- ✔ IP Transport
- ✔ Event Coordination
- ✔ Field Operations
- ✔ Production Services
- ✔ Channel Playout



+1 678.421.6834 | [TESbookings@encompass.tv](mailto:TESbookings@encompass.tv) | [www.encompass.tv](http://www.encompass.tv)



## MLB ALL-STAR GAME

PETCO PARK, SAN DIEGO

JULY 12

**F**ox Sports' MLB All-Star Game was bigger than ever, with a host of next-gen cameras and on-field audio technologies providing the big-game feel that viewers have come to expect from the Midsummer Classic.

Among the new tech toys at Petco Park were a Sony HDC-4800 ultra-high-frame-rate camera in tight center, a Spidercam aerial system in Park at the Park, a Flare 4KSDI



camera on a MōVI three-axis gimbal, and a backstop robo overlooking home plate and featuring a Grass Valley LDX 6X slo-mo camera.

“As one of our jewel events, we want to own this event and put a Fox stamp on it,” said Mike Davies, SVP, field and technical operations, Fox Sports. “As always, having the All-Star event in the middle of summer gives us some time to plan out some interesting things that we’ve wanted to try. We have some very cool new cameras and technology here that we’re very excited about and think we can bring back for the postseason.”

Fox deployed more than 35 cameras for game coverage at the All-Star Game, including a Spidercam aerial system, a Sony HDC-4800 ultra-high-frame-rate 4K camera, the 4KSDI camera, two Inertia Unlimited DirtCams, eight Fletcher robos (including the Grass Valley LDX 6X slo-mo), two Inertia Unlimited Phantom X-Mo ultra-slo-mos, several Sony HDC-4300's, and a fixed-wing plane aerial.

— Jason Dachman

*Fox Sports looked to put its stamp on the event.*

## PGA CHAMPIONSHIP

BALTUSROL GOLF CLUB,  
SPRINGFIELD, NJ

JULY 28-31

**T**he PGA Championship featured an abundance of innovative technology, a production compound 24 trucks deep, and even a live 4K show transmitted from Baltusrol Golf Club, but an enhanced graphics element stole the spotlight. For the production, CBS and Turner brought together Trackman radar tracking technology, GolfTrax shot data, and course re-creations from Animation Research Limited (ARL) to create a single graphics enhancement that provided a fresh, real-time, information-rich way to watch major golf coverage.

“This is exciting, and this is the next step [for golf production],” said Ken Aagaard, EVP, innovation and new technology, CBS Sports. “It’s a step that, personally, I’ve been looking to see golf take. I’m really, really pumped about this. This is a big deal for us. I think this is an area where we can move our golf coverage forward a significant notch.”

In the compound, CBS Sports’ four-truck SSCBS was the compound’s cornerstone. As for the rest of the trucks onsite, it was an all-star showing from many of the major truck providers. NEP had SS11, SS15, SS22 (A and B units), TS2 (A and B), Nickel, Chromium, NCP8 (A and B), and ESU. Game

Creek Video Encore A, B, and C units were there, along with Edit 1, which housed all onsite edit suites for the production. Broadcast Sports International (BSI) had three trucks on hand to support a robust RF deployment. And Mobile TV Group’s 39 Flex supported the 4K production of hole 4 that was sent to DirecTV.

It was another significant step forward in 4K production for CBS Sports. In partnership with DirecTV, CBS produced five-camera 4K coverage of the golf course’s signature par-three hole 4, airing it live to consumers on DirecTV. Besides offering distributed 4K coverage of hole 4, CBS Sports and DirecTV also took part in some internal testing of high dynamic range (HDR).

— BC

*The CBS/Turner compound housed 24 production trucks.*





# POP-IN-A-TRAILER

*A Mobile Transport Solution of The Switch*

Bringing FiveNines Network Availability and Quality  
to the Remote Television Production Experience

---

**#THE SWITCH**<sup>TM</sup>  
UNPARALLELED QUALITY. UNPRECEDENTED CONTROL.

[www.theswitch.tv](http://www.theswitch.tv)



Put an audio spotlight  
on your stars

PLAYERMIC<sup>®</sup>  
AQUAMIC<sup>®</sup>  
REFMIC<sup>®</sup>

Used by professional sports teams worldwide

[www.Q5X.COM](http://www.Q5X.COM)



# ateme

Transforming **Video Delivery**

The **Contribution** Market Leader

**Pure-Software** Solution  
for the Converged Headend

**UHD-HDR** Live-File Encoder & Transcoder

**AMS**

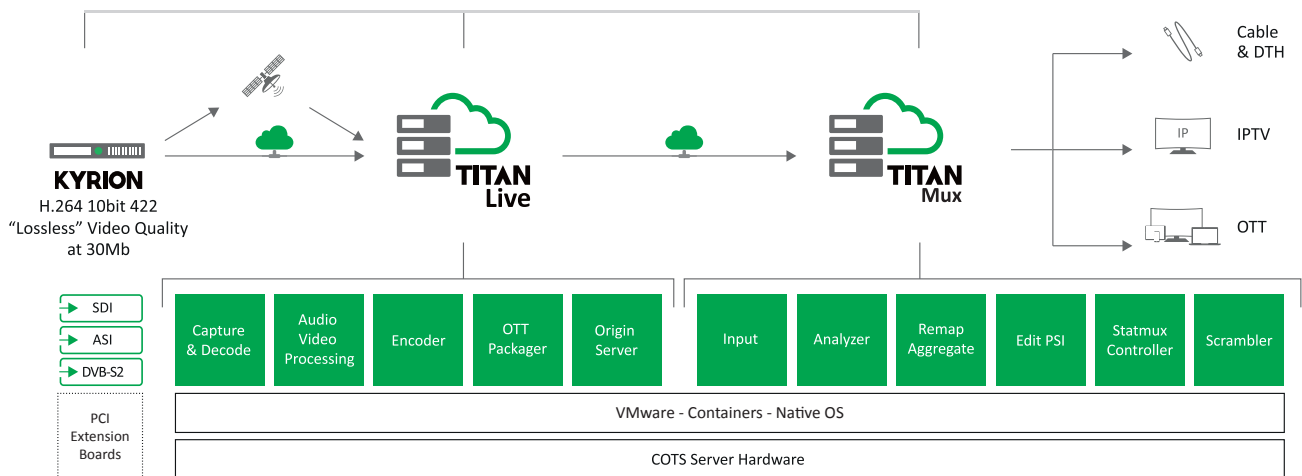

[www.ateme.com](http://www.ateme.com)

## 2016 OLYMPIC GAMES

RIO DE JANEIRO

AUGUST 5-21

**A**fter years of preparation, Rio 2016 came to a close in late August. For the production, the NBC Olympics team tackled a number of new workflows and also delivered an unprecedented amount of content, both on TV and online.

“I could not have been more proud of all that we as a team accomplished here in Rio and [at NBC Sports facilities] in



Stamford, Orlando, and Hiialeah,” said Dave Mazza, SVP/CTO, NBC Sports and NBC Olympics. “The entire team executed NBC’s most ambitious Olympics coverage plan to date, on all fronts: broadcast, cable, digital, and social.”

NBC Olympics broke its own records in terms of amount of coverage, amount of live coverage, and much more. U.S. fans were treated to 1,537 hours of coverage via broadcast and cable networks, and, as at the 2012 London Games, everything that OBS made available to NBC was streamed to viewers via the web and mobile apps (approximately 4,700 hours of content).

The NBC footprint in the IBC was similar to the one in London for the 2012 Games. It measured 73,000 sq. ft. and encompassed two large control rooms, one small control room, two studios (plus a small insert studio), and a 5,500-sq.-ft. news-production area. All the facilities were connected to NBC’s Stamford, CT, facility via four AT&T 10-Gbps fibers; the feed includes a backup of most signals. All told, more than 130 HD signal paths left Rio and headed to the U.S. with the help of MPEG, J2K, and IP encoding. Most of the signals went to Stamford, but others were sent to the 30 Rock facility in New York City, Golf Channel in Orlando, Telemundo in Florida, and NBC’s Dry Creek facility in Centennial, CO. — *KK*

*NBC Olympics delivered 1,537 hours of coverage to broadcast and cable.*

## US OPEN

USTA BILLIE JEAN KING  
NATIONAL TENNIS CENTER,  
FLUSHING MEADOWS, NY  
AUGUST 29-SEPTEMBER 11

**I**n its first year as host broadcaster and sole domestic-rights holder of the US Open in 2015, ESPN transformed the production compound at the USTA Billie Jean King National Tennis Center (NTC) from a cavalcade of broadcasters and trucks into a streamlined two-story production facility with a single office trailer across the street.

“When we went in last year, we didn’t know what we didn’t know,” said ESPN Director of Remote Operations Terry Brady. “This year, we had a much better idea of where things needed to be and how things needed to work. We also learned a lot in terms of how to manage the crew. After our experience last year, we’ve made a lot of small changes operationally and technically that make a big difference for this year.”

Now in the second year of an 11-year rights deal with the USTA, ESPN covered seven linear-TV courts with traditional manned cameras and audio out of nine control rooms at the broadcast center. Five other courts (one more than last year) had Sony Hawk-Eye SMART coverage, with automated

cameras following the action. A total of 275 technicians, 30+ engineers, and more than a dozen operations staffers were on hand, and approximately 9,500 pieces of equipment and 111 cameras (plus 28 cameras for freeD replay) were deployed on the NTC grounds to support the host, ESPN domestic, and ESPN International operations.

ESPN’s 139-camera complement included 91 standard broadcast cameras, 20 Hawk-Eye SMART units, and 28 freeD cameras, as well as familiar gear from last years’ coverage: Spidercam aerial system, rail cam, HoistCam, and WingVision aerial shot. Coverage of the Arthur Ashe court featured more than 20 cameras on average — including Spidercam, rail cam, an NAC/Ikegami Hi-Motion II ultra-slo-mo system, two Sony HDC-3300 3X slo-mo units, a roving RF camera, and seven robos — also took part in internal testing of HDR. — *JD*

*ESPN covered seven courts with manned cameras, five others with robos.*

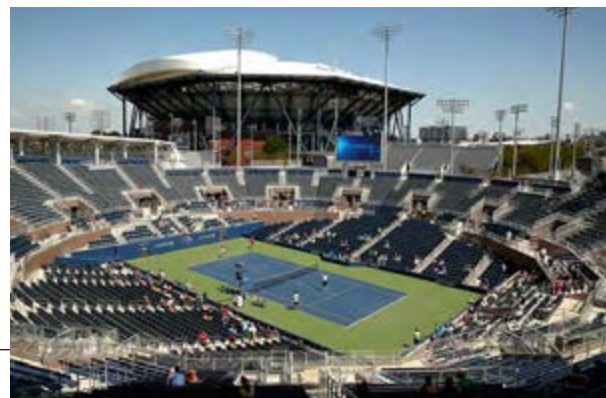



# Microsoft

Microsoft Azure  
The cloud on your terms

[azure.microsoft.com](https://azure.microsoft.com)



proud premier sponsor

# SHARE THE MOMENT

Capture the moment and share it with millions of sports fans around the world. Major sporting events – like the Olympics, the African Cup of Nations, the FIFA Confederations Cup or local football leagues – unite fans to cheer their teams through the nail-biting tension, unbelievable goals, unexpected upsets, and spectacular victories.

Extend your reach to new audiences with SES's fleet of more than 50 satellites, and immerse them in live can't-miss sports events.

Broadcasters rely on our global network and proven track record to bring the most exciting plays to viewers, wherever they are. Enhance your audience's viewing experience further by transmitting your content in HD or Ultra-HD. With flexible and reliable connectivity solutions tailored to your specific needs, we help you share those defining moments with audiences worldwide.

Find out more at [www.ses.com/ou](http://www.ses.com/ou)

**SES**<sup>▲</sup>  
beyond frontiers



**SGL has an established history serving the archive needs of sports facilities around the world.**

SGL's archive and storage management solutions include FlashNet Lite. FlashNet Lite is a single server, entry level solution combining the power and flexibility of FlashNet with the elegance of FlashNet Infinity, at a highly compelling price.

Whether you're bringing in live sports feeds, breaking news or managing sensitive content, our solutions can handle your requirements with ease.



T: +1 513 618 6108 | E: [sales@sglbroadcast.com](mailto:sales@sglbroadcast.com) | W: [sglbroadcast.com](http://sglbroadcast.com)

**Global leaders in Archive & Storage Management**



# ACROSS THE POND

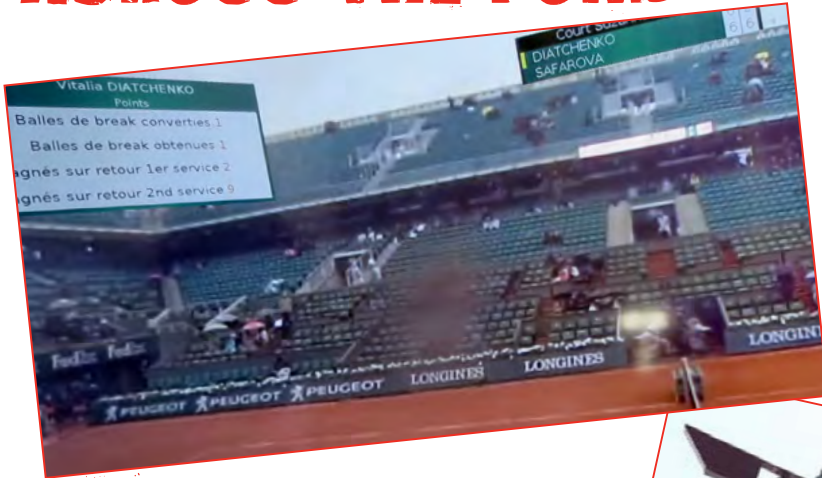

◀ **FRENCH OPEN**  
ROLAND-GARROS, PARIS  
MAY 22-JUNE 5

▼ **CHAMPIONS LEAGUE FINAL**  
STADIO GIUSEPPE MEAZZA, MILAN  
MAY 28

The U.S., Canada, and Brazil weren't the only countries to host major sports events in 2016. European broadcasters pushed the envelope and made strides in sports-production technology with their coverage of tennis, soccer, golf, and more. Here are some of those events:

▼ **WIMBLEDON**  
ALL ENGLAND LAWN TENNIS AND CROQUET CLUB, WIMBLEDON, UK  
JUNE 29-JULY 12



▲ **UEFA EURO FINAL**  
STADE DE FRANCE,  
SAINT-DENIS, FRANCE  
JULY 10



◀ **THE OPEN CHAMPIONSHIP**  
ROYAL TROON,  
TROON, SCOTLAND  
JULY 14-17

# SOS

Global Express

Event Logistics



AROUND THE WORLD ...  
AROUND THE CLOCK

## READY FOR 2017 & 2018 EVENTS

SEE YOU AT  
CONFEDERATIONS CUP AND THE OLYMPIC GAMES!



### TAILOR SIZED TRANSPORT SOLUTIONS

AIR CARGO • SEA FREIGHT • TRUCKING SERVICES  
• AIR CHARTERS • CUSTOMS CLEARANCE •  
ATA CARNETS • ONBOARD COURIERS

### BASE IN MOSCOW

For upcoming  
Confederations and  
World Cup Games



## Opening soon in Asia!

### USA

sos@sosglobal.com  
1-800-628-6363

### Germany

info@sosglobal.eu  
+49 40 611 6407 11

### UK

sos@sosglobal.co.uk  
+44 170 729 1570

### Russia

info@sosglobal.ru  
+7 925 417 31 06

[www.sosglobal.com](http://www.sosglobal.com)

[www.sosglobal.eu](http://www.sosglobal.eu)

## STATION



- Decoders
- Master Control
- File Transfer
- Configuration/Monitoring

## DVR & ARCHIVE



## CDN



- YouTube Live
- Ustream
- Wowza
- Livestream and more

# CORE



## CUBE

Compact  
H.264 Codec



## SLICE

Rack-mount  
H.264 Codec



## T-RAX

Enterprise high density  
H.264 blade system



## BOND

Ultra compact  
H.264 cellmux

Manage your IP video deployments securely from anywhere in the world with the Core Cloud Platform. View, configure, monitor and record each of your Teradek codecs in real-time or route your video feeds to any number of destinations, including CDNs with Core's intuitive drag and drop user interface.





# The Future Proof TV Air Chain

Audio over IP has arrived. Are you ready?

AERO.soft™



AERO.soft™ NRemote



SDI xNode™



With standard Livewire+ AES67 Audio over IP connectivity, Linear Acoustic **AERO.soft™** is a dedicated server-based audio processing engine featuring award-winning Linear Acoustic AEROMAX® loudness control, UPMAX®-II stereo-to-5.1 upmixing, and Dolby® coding.

**SDI xNode™** is a 1RU 1/2 width dual HD/SD-SDI embedder/de-embedder capable of extracting and re-inserting up to 8 Livewire+ AES67 AoIP streams.

Linear Acoustic **AERO.soft™** and **SDI xNode™** – the flexible, scalable solution for today's TV air chain and beyond.

Learn more about AoIP in broadcast from the TV SOLUTIONS GROUP of THE TELOS ALLIANCE. [www.telosalliance.com/tvsg](http://www.telosalliance.com/tvsg)

**LINEAR ACOUSTIC®**  
by Telos Alliance

**TV SOLUTIONS GROUP**  
[telosalliance.com/Linear](http://telosalliance.com/Linear) · [tvsg@telosalliance.com](mailto:tvsg@telosalliance.com)



LOS ANGELES

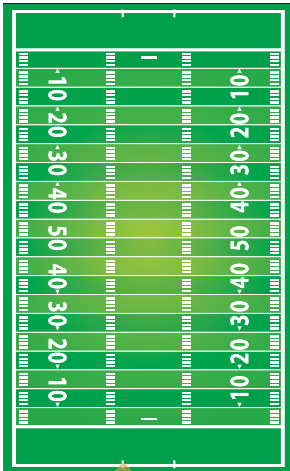

MONTREAL

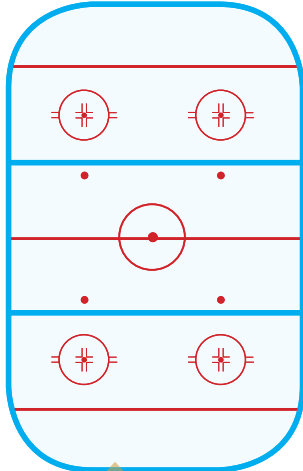

ROME



SYRACUSE

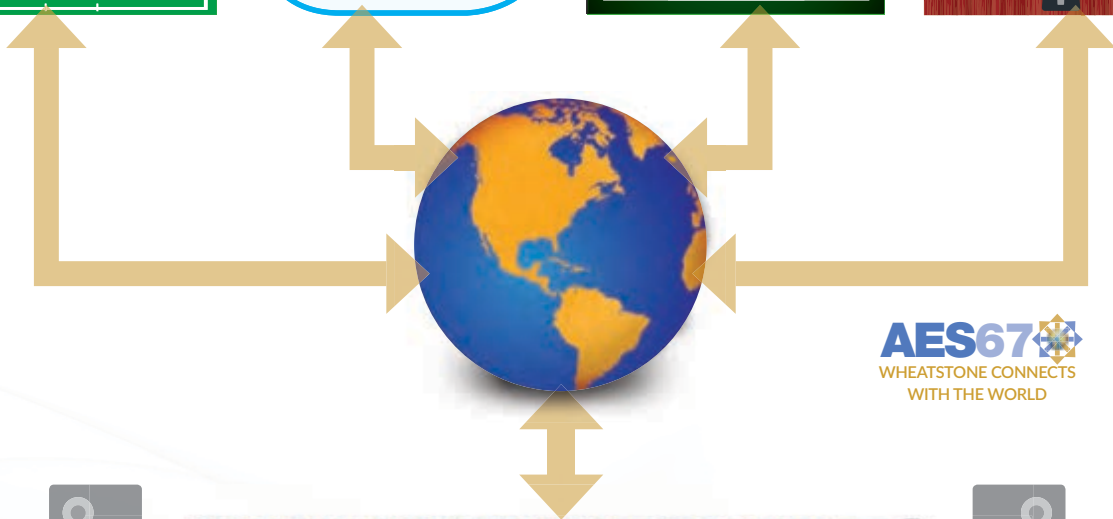
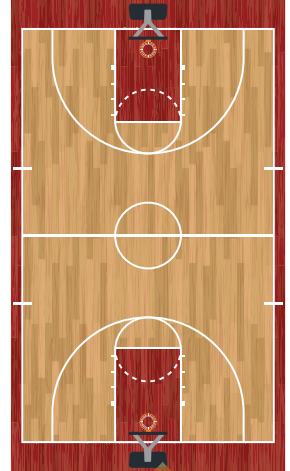

**AES67**  
WHEATSTONE CONNECTS  
WITH THE WORLD



MIXING CONSOLE AT HOME CONTROLS AUDIO AT REMOTES

## EVERYTHING YOU NEED TO BRING THE GAME HOME

Wheatstone's at-home remote IP audio systems provide reliable realtime and automated control of your audio – including zero latency local IFB, mix-minuses, and mic processing – between remotes and home control room. It's like having remote events right in your studio.

**AT-HOME**  
**PRODUCTION**  
REMOTE-INTEGRATION MODEL

Learn more: [wheatstone.com/at-home-production](http://wheatstone.com/at-home-production)

# NEW TRUCK Profiles

## & MOBILE SERVICES PROVIDERS



All Mobile Video	86	DX3 Media	146
Dome Productions	90	Encompass Digital Media	150
Game Creek Video	94	F&F Productions	150
Gearhouse Broadcast	98	Filmwerks International	150
IMS Productions	102	Fletcher Sports	150
Mobile TV Group	106	Gerling & Associates	150
NEP Broadcasting	110	Illumination Dynamics	150
Proshow Broadcast	114	Inertia Unlimited	150
TNDV Television	118	Integrated Media Technologies	154
Token Creek Mobile TV	122	Jones Mobile TV	154
Viacom Media Networks	126	Kaufman Broadcast	154
3g Wireless	133	KMH Audio-Video Integration	154
Aerial Video Systems	133	Kodiak Mobile Television	154
AerNow	133	LH Computer Services	154
Alliance Productions	133	Little Bay Broadcast Services	154
Alpha Video	133	Lyon Video	158
AV Design Services	133	Markertek	158
Azzurro Group	133	Metrovision	158
BeckTV	138	MPS	158
Bexel Global Broadcast Solutions	138	PRG	158
Broadcast Services International	138	Program Productions	158
Broadcast Sports International	138	PSSI/Strategic TV	158
Calhoun Satellite Communications	138	Raycom Sports	158
Calient Technologies	138	Reality Check Systems	162
CAT Entertainment Services	138	RoboVision	162
CBT Systems	142	Rock-It Cargo	162
Chesapeake Systems	142	Ross Mobile Productions	162
CineSys-Oceana	142	Saunders Electric	162
Clark Media	142	SDTV	162
CMG Mobile	142	Skycam/Cablecam	162
Communications Engineering Inc.	142	SMT	162
CP Communications	142	sonoVTS	166
Creative Mobile Solutions	146	SOS Global Express	166
CSP Mobile Solutions	146	The Switch	166
CTG	146	TL Mobile Television	166
Digital Comm Link	146	Unity Systems Integration	166
Diversified	146	VER	166
DNA Studios	146	VISTA Worldlink	166
Duncan Video	146	YES Productions	166



# cameras for live 360 VR



## Vantrix PRO25

Designed for the ultimate capture quality with up to 5000 x 5000 pixels, 12-bit and 240fps.



## Vantrix PRO25-AQUA

Designed for operation underwater up to 60m depth.



## Vantrix PRO4-DUAL

Designed for fixed and mobile operation, with resolutions up to 2000 x 2000 and two lenses for full sphere 360x360° video.

The Vantrix PRO series is a purpose-built broadcast-quality capture system for live events such as sports, news, concerts as well as studio and post production. Vantrix PRO cameras complement the Vantrix 360 turnkey system for glass-to-glass delivery of immersive VR content.

- Single lens, 360x182°, no stitching required
- Dual lens full sphere available
- Simultaneous broadcast and live streaming
- 4 virtual cameras HD-SDI @ 60fps
- Optimized for live sports with low latency, high frame rate and advanced color grading

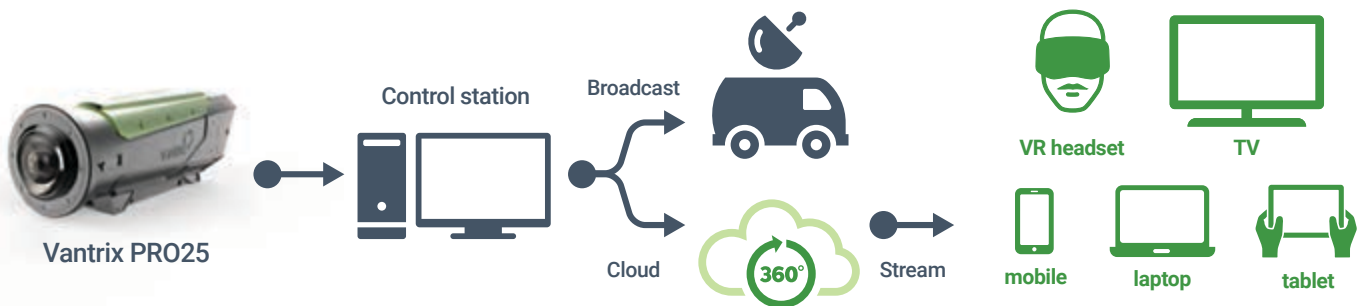

**Contact us today** and step into a bold new immersive universe.

### About Vantrix

Vantrix is a global leader in next generation video services for transcoding and 360 virtual reality systems. Since 2004, Vantrix products have been deployed in over 75 networks, serving over 1 billion subscribers worldwide.

### Learn more about Vantrix @

[www.vantrix.com](http://www.vantrix.com)

[marketing@vantrix.com](mailto:marketing@vantrix.com)

T: +1.514.866.1717

/VantrixCorp

/vantrix

/Vantrixcorp





The Single-Most Important Supplier to the Broadcasting Industry.



PROFESSIONAL

# Broadcast Fiber Essentials!

## Fiber Power!

Inject DC Power to Your opticalCON Cables!

**FIBERJUICE**  
Safe DC Power for Fiber

## TAC Attack!

2-CH to 12-CH Tactical Reels Built to Your Specs



## SMPTE Hybrid!

Built to Your Specs!



## JACK REEL HEAVY DUTY!



Fiber Rated! Heavy Duty! Huge Capacity! (1000 Foot+ SMPTE)

**\$355**

## Fiber Repairs!



The Best Fiber Repairs In the Industry! Let Us Prove It!



## Pro-Audio Fiber!



2-CH Line/Mic Fiber Extender

**SESCOM**

Both Battery & AC Powered

## HDMI Extender!



Fantastic Value!

**CAMPLEX**  
Brand Fiber Gear

## Tac Adaps!



Super Rugged Tactical Fiber Adapter Cables!

Field Tough!



## Fiber Extenders!



Largest Industry Selection!

## Fiber Cleaners!



Largest Collection in the Industry!



## CAMPLEX

Super Value!

Send 3G-SDI Over 6 Miles of Fiber!



ST or LC

## Fiber Reel Deal!



**JACK REEL**  
Designed for Fiber Stock Up!  
**\$59<sup>95</sup>**

**Your Expert Fiber Source!**

**Award Winning Customer Service!**

**800-522-2025**  
www.markertek.com  
email sales@markertek.com



# GET THE MOST OUT OF YOUR SPORTS CONTENT

Sports fans are more discerning than ever, demanding highest quality viewing experiences across any and all of their screens and devices. Expand your services and deliver the next generation of TV with Ericsson's comprehensive portfolio of HEVC solutions.



# set & lighting design

sports  
news  
lifestyle  
multi-channel



Creativity·Knowledge·Innovation

[www.ddgtv.com](http://www.ddgtv.com)

970.349.5836

# ALL MOBILE VIDEO

## New Media Spurs Zurich's 4K Success

By Ken Kerschbaumer

**Z**urich, All Mobile Video's latest production unit, hit the street in the summer of 2016 as a result of entertainment-community demand for 4K production capabilities. Already, the AMV team is finding that 4K production is, increasingly, a reality.

"New-media outlets, such as Netflix and Amazon, are dictating that their content be produced in 4K," said All Mobile Video President Eric Duke. "That is right up our alley, having extensive prior experience with multicamera production utilizing both standard 2/3-in. and large-sensor cameras in a television workflow. Now that AMV has incorporated Sony PMW-F55 large-sensor cameras with full SMPTE fiber-optic CCU functionality, along with the Sony HDC-4300 2/3-in.-format cameras, we can offer the cinematic aesthetics of large-sensor capture with the efficiencies of multicamera live-switch and live-shaded production workflows."

Zurich comprises two trailers: an A unit that can expand to be 59 ft. long and nearly 16 ft. wide and a B unit that is 58 ft. long and 8.5 ft. wide. The A unit houses the main production area, audio control, a record/ingest, and video control. The B unit is capable of housing additional recording/playback options as well as other support services.

Among the technical highlights is a Sony XVS-8000 3G switcher with 5M/E, a Studer Vista X audio console with 72 faders, 12 Sony HDC-4300 and six Sony F55 fiber/CCU 4K cameras, up to four eight-channel Sony PWS-4500 servers, an RTS ADAM OMNEO intercom, extensive MADI audio routing, and 128 channels of Dante I/O.

"The online-streaming entities and forward-thinking cable/broadcast outlets want the highest possible quality images, and they are driving the demand for 4K, which is already more pronounced than the demand for 3D ever was," said Duke. "Over the web, the 4K images look better, and the clients are banking on the higher quality giving them a better return on their upfront investment."

One of the challenges of 4K production for entertainment is image capture. Over the years, AMV has worked with Cinedeck, Sony, and other manufacturers to provide various options capable of multiple codecs as well as format-record capabilities.

"We have worked with Cinedeck to enhance their new series of ZX servers. These recorders have proved quite reliable and can be used for 4K or HD recording," Duke explained. "The Sony PWS-4500 server can also record 4K content or HD, which we can back up using the Cinedeck ZX recorders or provide our



*Zurich hit the road in response to rising demand for 4K production.*

clients with a walkaway system in the form of a Smalltree NAS [network attached storage].

"The downside to 4K," he continues, "is the amount of storage required. Our PWS-4500 HD servers can record eight sources, but, when recording 4K content, we can record only three or four sources per DDR. The Sony PWS-4500 DDRs also give us playback and edit functions in multiple record formats, similar to an EVS but with greater format versatility."

For example, the production at Yankee Stadium for a Garth Brooks concert required 27 cameras to be recorded for two three-hour shows. That required a lot of storage and also some new workflows to ensure that clients had all the options they needed in the codec of their choosing. Specifically, the servers offer the kind of flexibility required, because each client tends to have a favorite format or "look."

"The Sony server bridges those worlds, as it can record multiple formats and codecs," said Duke. "The key with 4K is having an end-to-end workflow solution including redundant copies of the deliverables for the client as required."

When the truck first hit the road, only about 20% of the shows were in 4K. In just a few months, that has risen to 50% as clients rethink their plans and decide to make the leap to 4K.

"There is a 4K market, and it is new media that is driving it, rather than old media," said Duke. "And now, as HDR is adopted, it's becoming the Holy Grail, offering viewers at home a more engaging experience whether they are viewing in 1080 or Ultra HD resolutions. We see HDR as another arrow in our quiver for those who want these expanded visual technical capabilities brought to their audiences." 



IMAGINE THE HIGHLY IMPROBABLE...



**7** | **MASTER**  
**SERIES** | **REFERENCE**  
**MONITORS**

Next-Gen Monitoring in Audio Control Rooms

Answering the call for next-generation monitors in Post Audio and Broadcast facilities, the JBL 708i and 705i deliver remarkable imaging, jaw-dropping output and response from install-ready compact enclosures. The complete system features networked audio, central control, and is scalable for any number of channels in any size room. **Learn more at [www.JBLPRO.com/7Series](http://www.JBLPRO.com/7Series)**

Hear the truth.



©2016 HARMAN INTERNATIONAL INDUSTRIES, INCORPORATED. ALL RIGHTS RESERVED. FEATURES, SPECIFICATIONS AND APPEARANCE ARE SUBJECT TO CHANGE WITHOUT NOTICE.



**In Live Sports,  
 Viewers Expect  
 the Highest Quality**

**FOR.A**<sup>®</sup>  
[www.for-a.com](http://www.for-a.com)

**FRAME RATE CONVERTER**  
**FRC-9000** De facto standard of frame rate conversion



- 4K (UHD)/3G/HD/SD multi-format support (4K is optional)
- Conversion with Motion Compensation Processing
- Scene Cut Detection
- Interface-to-Progressive conversion
- Simultaneous conversion of 2-channel video inputs (optional, when using 3G/HD-SDI mode)
- Front touch panel and web browser control
- 16-channel AES/EBU I/O (48 kHz, 24-bit: optional)
- FRC-90DA (optional): AES/EBU digital audio
- FRC-90DM (optional): Dolby E 2-channel encoder/decoder (required FRC-90DA mounted)

Simplicity is the ultimate  
**Sophistication**

**NEW PLATFORM AVAILABLE NAB 2017**



**PESA**

[www.pesa.com/NAB17](http://www.pesa.com/NAB17)

# Take your live events to the house.

When all eyes are on the big game, the pressure's on you to keep your online video streaming. Verizon Digital Media Services' Live Streaming Solution is the industry's only fully integrated solution to simplify your live event workflows, from ingestion to playback on any screen, anytime, anywhere.

**Learn more at:**

**[www.verizondigitalmedia.com/solutions/live-streaming/](http://www.verizondigitalmedia.com/solutions/live-streaming/)**



# DOME PRODUCTIONS

## Pioneer Expands Commitment to 4K/UHD in Canada

By Karen Hogan Ketchum

**D**ome Productions continues to serve Canada's thriving 4K/UHD sports market with its latest mobile production unit, Pioneer. The 4K/UHD-capable truck has had plenty to keep it busy since hitting the road in July for TSN's coverage of a Toronto FC match at BMO Field; Pioneer has also covered the Canadian Football League and a variety of sports and entertainment productions and will continue to cover the Toronto Raptors as well as a number of NHL games throughout the 2016-17 season.

The most recent addition to Dome Productions' 4K arsenal, Pioneer gives the Toronto-based mobile-production provider additional flexibility to service the 4K-production needs of its television partners, Rogers Media and Bell Media.

Pioneer features a Grass Valley 2M/E K-Frame switcher, EVS EQX routing switcher with 135x112 UHD video capacity, four three-channel EVS UHD LSM XT3 replay servers, ChyronHego Mosaic graphics engine, and Calrec Artemis Beam digital console with Bluefin2. The truck is wired for 10 Sony HDC-4300 cameras and carries a variety of Fujinon 4K lenses. It services HD productions in addition to its 4K slate; the on-board technology and cameras simply run in a different configuration.

"When we were asked to come up with the solution to produce 4K, we realized that 4K has to be a single truck unit," said Mary Ellen Carlyle, SVP/GM, Dome Productions. "The team figured that out, and, on July 1, they put out a single solution. One [television partner] is taking a 4K feed directly and downconverting to HD at their plant. The other one's downconverting it at the truck, and we're spitting out 4K and HD. Our challenge was to give them the tools that they need to produce in the way that they always had

*Pioneer is designed to produce 4K and HD in a single truck.*



*Inside Pioneer, which can be reconfigured to produce an HD show*

produced, without losing the integrity of the HD show."

Dome Productions' first foray into 4K production occurred in early 2016, when both Rogers and Bell announced that they would deliver NBA and NHL games live in 4K to their subscribers. The company's first 4K show — TSN's coverage of a Toronto Raptors game at Air Canada Centre — was produced in side-by-side mobile units dedicated to powering the 4K and HD productions, respectively.

The side-by-side model, however, was always intended to be a stop-gap solution until one of Dome Productions' existing trucks, Trillium, could be configured to handle 4K. Because Rogers announced its 4K plans in October, Dome had only four months before Sportsnet's scheduled 4K broadcast of the Maple Leafs on Jan. 23.

"We couldn't produce a Pioneer in four months. There's no physical way we could have done that, even if we found somebody that had a trailer," explained Carlyle. "Trillium was a stepping stone to get there. [Director of Engineering] Mike [Johnson] and his group put together a layer of 4K on top of the HD — basically, as a B unit — so they can operate in HD and, if it needs to be 4K, all the guts of the 4K are in the B unit. But that's not where we wanted to stay."

Now that Pioneer is on the road as a true standalone 4K production unit, Dome Productions is hoping to transform Trillium from a temporary 4K option in two trailers into a permanent 4K solution that can fit in one. The reconfigured Trillium, which will make use of the original Trillium's Grass Valley K-Frame production switcher and 10 Sony HDC-4300 cameras, is scheduled to roll out some time in 2017.

"We have two partners that adopted 4K strategies, and both wanted to enter the 4K market. We couldn't say the truck's not available," said Johnson. "Now, with two trucks, they could both be doing 4K on a given night at the same time." 



# Joseph ELECTRONICS



**TOTE CADDIE**



**BOOTH CADDIE**



**WAVESHIFTER 4**



**JE200-TE &  
JE320-TE**



ONLY AT  
JOSEPH ELECTRONICS  
EXCLUSIVELY FOR  
TRUCK WALLS

## COPPER TRIAX XLRs REPAIR TACTICAL LC/ST/SC FIBER DT12 LEMO SMPTE ETHERCON ASSEMBLIES NEUTRIK OPTICAL CON



**IN-HOUSE FIBER AND COPPER LAB**  
**COPPER AND FIBER ASSEMBLIES AND REPAIRS**  
**CUSTOM FIBER TRANSPORT SYSTEMS**  
**CUSTOM PANELS**





**OUTSTANDING SERVICE AND SELECTION.  
LICENSE MUSIC WITH THE BEST.**

**Contact Us Today!**

sports.apmmusic.com •  @APMSports • 323.461.3211 (LA) • 212.856.9800 (NY)



Single Fiber  
Compact  
Built-in Router  
Modular  
Multipurpose  
MSA Compliant  
3rd Party Integration  
Intelligent Control



Multiple Cables  
Rack Space  
Limited Features  
Fixed Architecture  
Simplex  
Expensive  
Proprietary

**Barnfind > Competition**



### BarnOne Frames

World's most flexible transport platform. Multi-function, 32x32 matrix, low power consumption, signal transport platform which allows numerous signals in one frame. Supports common video and telco formats including SMPTE-2022-6, SDI, SDTI, HD-SDI, 3G, ASI, STM-1 Telco, HDMI, DVI, 4K 60p, CAM-CCU, AES, MADI, KVM, and IP/Ethernet. Management over Ethernet LAN or in-band over fiber. Multiple models available.

### BarnMini

Small portable, cost effective, devices for the single channel extension of BNC, SFP, GPIO, Ethernet, and/or HDMI connections. Supports cable equalization and reclocking. Can be used standalone or as nodes in a Barnfind network.



### MSA Compliant SFPs

Non-proprietary, Single and Multi Mode, BIDI, CWDM, DWDM, and Speciality Video SFP Transceivers. Interface to nearly any source or destination imaginable. Low cost, fully tested, and warranted by Barnfind. Choose from over 50 different SFP options.



**FIBER TRANSPORT. MULTIPLEXING. ROUTING. CONVERSION.  
DISTRIBUTION. IP/ETHERNET. 4K WORKFLOWS. CAM-CCU.**



[barnfindamericas.com](http://barnfindamericas.com)



888.491.6903

# GAME CREEK VIDEO

## Madison for MSG Networks Ups 4K Game



By Jason Dachman

**G**ame Creek Video has played a key role in the evolution of live 4K sports production over the past year, retrofitting its Riverhawk truck to serve as MLB Network's primary 4K/HD mobile unit for the weekly MLB Network Showcase games delivered in 4K on DirecTV. Now Game Creek has taken its 4K game to the next level with the launch of Madison, its first purpose-built 4K/HD mobile unit, for MSG Networks — with more 4K units on the way in 2016.

"We decided internally that it made sense to make ourselves 4K-ready everywhere we could, so we elected to make Madison a 4K-capable truck coming right out of the gate," said Jason Taubman, VP, design & new technology, Game Creek Video. "We basically took the modifications we made to Riverhawk for 4K for MLB Network, and we baked those properly into Madison. The evolution from Maverick to Madison with some of the Riverhawk mods produces a single standalone 4K-capable truck. And when I say 4K-capable, I mean it is legitimately ready to do a 4K show today if called upon."

Madison, which launched in August, replaces Legends (launched in 2009) as MSG Network's primary production truck; Legends will continue to regularly work MSG shows. The new standalone single-expando truck is based largely on Maverick (a sister unit to Riverhawk), which has become the company's standard midsize model popular with RSNs.

Built around a 9M/E Grass Valley Kayenne K-Frame switcher (192 inputs/96 outputs), Madison rolled with 12 Sony HDC-4300 HD/high-frame-rate/4K cameras (it is wired for up to 20 in HD mode) with 95X Canon lenses. Although it will primarily be working HD productions for MSG Networks, the truck can quickly and easily be switched into 4K mode, thanks to its infrastructure and the 4K license available on HDC-4300's.

"When we want to do a 4K show, it's just a matter of putting the cameras in 4K mode, loading a 4K config into the switcher, and adjusting the replay area to have a channel count to support 4K," said Taubman. "After that, we're basically good to go. The infrastructure is fully 4K from end to end."

On the replay side, Madison is equipped with three EVS 12-channel XT3 servers (with high-speed XNet network and 10-Gbps fiber) and one EVS four-channel XT3 SpotBox.

"Right now, for MLB Network [Showcase] 4K games, we're doing replay in 60p currently," Taubman explained. "But, when the day comes when someone wants to do a fully native 4K show with 4K replay, we're ready to do that with up to nine EVS [servers] and 20 cameras."



*In addition to being 4K-capable, Madison significantly enhances MSG's audio capabilities with a Calrec Apollo console.*

Although, because of current technology constraints, Game Creek opted to go with a 576x1152 Evertz EQX HD-SDI video router rather than an IP router for Madison, Taubman doesn't rule out the prospect of installing an IP router in future mid-level truck builds. "We did [consider an IP router]," he says, "but it was a pretty easy no from a practical point of view at this time."

In addition to being 4K-capable, Madison significantly enhances MSG's audio capabilities, including a Calrec Apollo console (1020 channels, 133 12-layer faders, 128 mic/line input) and Evertz EMX router (384x384 AES, 256x256 MADI, 288x288 analog, 128x128x16 HD-SDI embedded). The truck travels with Sennheiser and Audio-Technica shotgun mics, Electro Voice handheld mics, and Sony lavalier mics.

"This truck represents a big upgrade in terms of audio," Taubman pointed out. "We're also working on some other exciting things on the audio side. We have been working with [vendors] to iron a few things out, and we're excited about what's coming down the line."

Also aboard Madison are ChyronHego Mosaic XL graphics, RTS ADAM 272-port intercom system, IHSE Draco Tera KVM router, and Evertz frame syncs and up/down/crossconverters.

"The Evertz [up/down/crossconverters] operate in two different modes," said Taubman. "In the first mode, we have 30 dual HD paths. In the second mode, we can turn them into pairs for 4K. So it would be either 30 HD paths or 15 4K up/down/crossconverters."

Madison is just the beginning of a 4K boom for Game Creek, which also launched 4K-capable units in Nitro and Chesapeake in late 2016 and has more on the way. 



# Panasonic



## THE **NEW** AK-UC3000 4K /HD CAMERA WITH HDR

### Designed for the Field, Studio and Today's Challenging Production Economy

The AK-UC3000 2/3" 4K Single MOS Studio Camera delivers exceptional color, quality and the flexibility of a simultaneous Full HD output allowing you to interface into today's HD systems but with the capability for a 4K future.

This High Dynamic Range-ready camera offers many innovative features from advanced focus assist functions, multiple video/data trunk lines, to a CCU that can output UHD with the AK-UC3000. Also, in cases where high-speed video content is desired, you can use the companion AK-HC5000 camera-head in the same system, capable of 240 frames per second in HD.

Its familiar and new generation of ROPs allow easy viewing of CCU and camera menus on its LCD screen, and its buildup unit and master setup unit offers a highly flexible and simple, total system.

Request a demo today at [us.panasonic.com/UC3000](http://us.panasonic.com/UC3000)

© 2016 Panasonic Corporation of North America. All rights reserved.



The new Sennheiser EK 6042

# ONE RECEIVER FITS ALL

2 Channel hybrid receiver for digital and analog transmitters



## EK 6042 – Two channel camera receiver

Our new EK 6042 two-channel slot-in receiver can connect to virtually every Sennheiser wireless system – be it analog or digital (including G3, 2000 series, 3000/5000 series and digital 9000). With the built-in web server, setup is easily managed using any browser including imports and exports of the entire configuration.

The EK 6042 is SuperSlot™-compatible and works seamlessly with your existing equipment. Same goes for ARRI®, Panasonic® and Sony®. And, yes, the EK 6042 works stand-alone as well. When we say, “One receiver fits all”, we mean it.

harmonic®

PRESS  FOR STORAGE



## Storage for the Biggest Games

**Team Up with Harmonic MediaGrid 4000.** The need for high-density, high-performance storage has never been higher—especially for broadcasting the world's leading sports events. Enter MediaGrid 4000, with up to 144 TB of raw storage in 4 RU. Blazingly fast and incredibly reliable, MediaGrid 4000 delivers new levels of media throughput and availability at the lowest possible TCO. More channels, more content, more editing. **Bring it on.**

Learn more at [harmonicinc.com](http://harmonicinc.com)



UHD



Cloud



Multiscreen



Services



Playout

# GEARHOUSE BROADCAST

## 4K 'Supertruck' Columbus To Hit U.S. Market in 2017

By Brandon Costa

**W**hen it comes to 4K/UHD, few mobile-production companies have been more at the forefront of the next format of broadcast technology than Gearhouse Broadcast. The company launched its first 4K truck — HD8 — more than a year and a half ago in Australia, was one of the first to invest in DYVI switchers from EVS, and has already used Aperi's native-IP live-production platform. Now the company is moving forward with its second dedicated 4K "supertruck" designed for the U.S. market, Columbus.

Its design is rooted in its forefather, HD8, but it is built specifically with the U.S. sports and entertainment market in mind. According to Marc Genin, managing director, Gearhouse Broadcast USA, the mobile unit features two split production areas, enabling simultaneous production of a main cut and a sub cut for any other program — be it a Spanish-language or visiting-team feed.

He notes that the solutions are in place today to use 4K technology to broadcast higher-resolution images in HD. So broadcasters don't have to wait until the 4K distribution gets figured out to start working with 4K tools. "This is what we're delivering with Columbus," he pointed out, "a practical way of creating 4K content that doesn't require the adoption of lots of new technologies or additional extensive training for production crews."

The 60-ft. production truck is a behemoth housing a Grass Valley K-Frame production switcher with 96 inputs and 24 outputs. The unit is built around an Imagine Communications



Platinum IP3 28RU router and leverages the camera power of the Sony HDC-4300 and/or the Hitachi SK1200. Columbus also features four EVS XT3's (with 4K capability) for replay.

The truck also will have the first U.S. installation of a Lawo audio desk and 4K monitor wall in a UHD production truck. The wall will comprise 24 Boland 4K monitors, driven either as quad splits or as single-input 4K monitors from the main router, giving it flexibility in HD or 4K.

Gearhouse's goal is to simplify the 4K production and make it a more welcoming medium for live-production and operations teams. Though acknowledging that completing the transition will be a lengthy process, the company sees an opening in the market, with IP workflows appearing to be paving a path to more 4K/UHD production in the future.

"We wanted to provide a solution that will show content producers that acquiring and delivering 4K broadcasts is possible with the technology we use now," said Genin, "just like we've done with our supertruck in Australia."

Gearhouse saw the need to launch a mobile unit in the U.S. simply in response to the sheer scale of live productions that need to be served. The company's U.S. branch has built a strong reputation for mobile-production support, recently playing a key role in development of broadcast-production facilities used at the USTA Billie Jean King National Tennis Center for the US Open.

Columbus will be based in Gearhouse's Los Angeles facility but will be ready to serve the entire North American market beginning in 2017. 



*Columbus, shown here at Gearhouse Broadcast's L.A. facility, will hit the road in North America at the beginning of 2017.*

# CONNECT LIVE CAMERAS TO VARIED VENUE CABLING MORE COST EFFECTIVELY!

All HITACHI Cameras can be controlled by Ross Dashboard



In live television, cameras often need to connect with different cabling at different venues. HITACHI's new CU-HD1300FT is a camera control unit (CCU) that enables cameras to switch between SMPTE fiber, single mode fiber, or Triax without needing to buy dedicated cameras, or costly stand-alone conversion units.

Instead, HITACHI provides fiber and copper cable technology right at the CCU, saving tens of thousands of dollars. To switch between camera cable forms, simply dock a fiber or Triax camera adapter to your HITACHI camera head, and connect at a fraction of the cost.

## Signal Transport Improvements

The CU-HD1300FT also offers improved performance for both SMPTE fiber and Triax signal transport. Triax cable runs can be significantly extended. Depending on the cable, runs of nearly a mile are now possible.

In addition, the CCU can now output all formats of HDTV progressive (3Gbps) and interlaced signals. Digital transmission is also provided over SMPTE hybrid fiber and COTS single-mode fiber cable.



All New HITACHI Cameras Are HDR Ready

**HDR**  
HIGH DYNAMIC RANGE

**To economically connect cameras to any venue cabling, give us a call.  
We can provide you and your cameras with the right connections.**

### Hitachi Kokusai Electric Inc.

Akihabara UDX Bld. 11th Flr.  
4-14-1 Soto-Kanda Chiyoda-Ku, Tokyo 101-8980 Japan  
Tel (81)3 6734 9432, Fax (81)3 5209-5942  
URL: <http://www.hitachi-kokusai.co.jp/global/index.html>

### Hitachi Kokusai Electric America, Ltd.

150 Crossways Park Drive, Woodbury, New York 11797 USA  
Tel (516) 682-4431, Fax (516) 496-3718  
General Information Email: [HKA.info@hitachikokusai.us](mailto:HKA.info@hitachikokusai.us)  
URL: <http://www.hitachikokusai.us>

**HITACHI**  
Inspire the Next

# ASTON REAL-TIME 3D GRAPHICS CREATOR CG & PLAYOUT



ASTON

Aston is a comprehensive graphics creation system built to be the centre of any design department and from there, through to CG and playout, fulfilling all the requirements of broadcasters, production services providers, and design houses.

**MORE INFORMATION**



**BRAINSTORM**

[aston.brainstorm3d.com](http://aston.brainstorm3d.com)



# COBALT®

ST-2206 GATEWAYS 4K UHD CONVERSION AUDIO PROCESSING  
KEYING & LOGO INSERTION UP/DOWN/CROSS CONVERSION

## KEEP YOUR EYE ON THE BALL

WITH  
COBALT® DIGITAL  
FIELD PROVEN  
PRODUCTS



BLUE  
BOX  
GROUP

BBQ000



openGear®

Deployed In The Most Demanding Sports Productions  
Since 1997

MULTIVIEWERS & PROBES COLOR CORRECTION A TO D/D TO A  
IPTV SYSTEMS METADATA MANAGEMENT 12-G SDI ROUTING  
FIBER TRANSPORT COMPACT ROUTERS SIGNAL MONITORING

**COBALT DIGITAL**  
*Engineering Beyond The Signal*

2506 Galen Drive Champaign, IL 61821  
Voice 217.344.1243 Fax 217.344.1245

[cobaltdigital.com](http://cobaltdigital.com)

# IMS PRODUCTIONS

## Killer Frost Caters to Pac-12 Networks' Slate of 'Multicam' Events

By Karen Hogan Ketchum

Looking to break into Pac-12 Networks' expansive sports schedule, IMS Productions rolled out a revamped truck dedicated to live productions of Olympic sports. The customized mobile production unit, dubbed Killer Frost, hit the road for Pac-12 Networks in late August.

Killer Frost, which follows Pac-12 Networks' trend of naming trucks after superheroes and comic-book characters, supports the network's successful "at-home" model by enhancing live productions for nearly 100 Pac-12 Olympic-sports events.

"We are very pleased to welcome IMS Productions to the Pac-12 Networks' extraordinary family of high-quality mobile-facilities providers," said Jonathan Leess, EVP, operations, Pac-12 Networks, in a press release. "With IMS Productions' remote-broadcast expertise and their commitment to building a unique, West Coast-based IP-transmission mobile unit for our network, we are well-positioned to continue our innovative, efficient broadcast methods for years to come."

The 30-ft. straight truck originally hit the road in 2013, serving as the second truck on Time Warner Cable Sports' Los Angeles Lakers package and supporting that network's Deportes feed during home games. However, as the needs for that package evolved and the truck was no longer needed, IMS Productions looked for a way to repurpose it while keeping it on the West Coast. The company set its sights on Pac-12 Networks.

"We've been working aggressively trying to crack that nut, if you will, to get into the Pac-12 business," said IMS Productions President and COO Robby Greene. "We do things on the West Coast with the Lakers; we do other shows out there for

*Killer Frost will support Pac-12 Networks' at-home production.*



*IMS Productions wired Killer Frost for a five-camera show.*

IndyCar, PBR. ... So the West Coast is where we're trying to get a better foothold."

IMS Productions completely gutted the three-year-old truck and rebuilt it with Pac-12 Networks' technological specifications in mind. Pac-12 required a truck that could support its at-home production — which the network refers to as "multicam" — via IP transmission. An Evertz Xenon 64x64 router was installed, and the truck was wired for five Sony cameras; in addition, the company installed an IP transmission infrastructure that Pac-12 Networks keeps under wraps.

For each Olympic-sports event, Killer Frost transmits the clean feed from the site to Pac-12 Networks' studio in San Francisco, where talent can provide voiceover, graphics can be added, and more.

IMS leveraged its existing assets to custom-build the unit for Pac-12, providing the network with a state-of-the-art and cost-effective method of broadcasting such sports as baseball, softball, lacrosse, water polo, and track and field. According to IMS, multicam productions out of Killer Frost require a production crew comprising only an engineer, an A1, and five camera operators, but the crew still has access to the amenities of a larger production truck.

Greene hopes to continue to grow the relationship between IMS Productions and Pac-12 Networks in the future, providing services for Pac-12's hundreds of events, no matter how big or small.

"IMS Productions is proud to partner with Pac-12 Networks to provide an efficient solution to deliver the technological tools necessary to connect Pac-12 fans with their favorite athletic events," said Greene. "Our team's years of experience and hands-on approach have allowed us to create a purpose-built unit that will seamlessly transition from one event to the next." 



# THE COMPLETE SOUND PICTURE

CREATE HISTORY WITH THE BRAND THAT'S HELPED CAPTURE IT.

Designed to tackle the toughest environments, BRH440M-LC and BRH441M-LC\* Broadcast Headsets now have the flexibility to match multiple I/O requirements using Shure's new headset cables with Neutrik® terminations. Experience superior audio quality, unmatched reliability, and maximum comfort that broadcast and media production professionals need to excel in any situation.

Learn more about Shure BRH Broadcast Headsets at [www.shure.com/americas/broadcast/overview](http://www.shure.com/americas/broadcast/overview)

\*BRH440M-LC and BRH441M-LC employ detachable cables. BRH31M uses an integrated cable.



BRH31M



BRH441M-LC



BRH440M-LC

[www.shure.com](http://www.shure.com)

© 2016 Shure Incorporated

**SHURE**<sup>®</sup>  
LEGENDARY  
PERFORMANCE™



# THIS IS SMART

## This is HDR.

What if you could deliver a consistently high-quality HDR experience, regardless of content format or input? Technicolor's smart HDR solution makes this possible by accepting a wide range of formats, and up-converting all SDR content to stunning HDR. And, by delivering SDR and HDR through a single stream, we minimize bandwidth utilization, avoiding the need for costly infrastructure upgrades and maximizing HDR coverage. Because HDR should belong to the many, not to the few. Get the whole picture. Visit [OpenHDR.com](http://OpenHDR.com)

ENTERTAINMENT INTENSIFIED. HDR UNLEASHED.



FEEL THE WONDER

**Vinten**

# VECTOR 750

The **Perfect Head** for  
**Exceptional 4K Sports Coverage**

**The Vector 750, with its unique pantographic perfect balance system, is the only system to allow perfect control of large sports cameras.**

- ▶ Shoot Fast Moving 4K while maintaining perfect control of your camera and your shot with our Pantographic mechanism's perfect balance, minimising the inertia of camera and lenses configurations.
- ▶ TF Drag ensures you never miss that perfect shot with guaranteed smooth movement from rapid whip pan to highly controlled minute movements.
- ▶ Earn a reputation for sharp, creative shots with a trusted, robust design that has continually evolved with the industry and been perfected over a 20-year period.



[Vinten.en.com/product/vector750](http://Vinten.en.com/product/vector750)

Innovating Perfect Control

# MOBILE TV GROUP

## First 4K Truck, New Dual-Feed Unit Hit the Road

By Jason Dachman

**M**obile TV Group's first 4K/HDR mobile unit, 39FLEX, debuted in April at The Masters for the first-ever live 4K sports telecast in the U.S. In 2016, MTVG also rolled out the latest iteration of its side-by-side dual-feed mobile units, 40HDX and 40VMU (visitor mobile unit).

"Mobile TV Group is leading the natural progression from HD to 4K and 4K/HDR," said Founder/GM Philip Garvin. "39FLEX is one of the first mobile units built from the ground up for 4K and 4K/HDR and will offer users a financially accessible 4K-production facility."

It can operate in either HD or 4K and is built around a 4K-capable Grass Valley Kayenne K-Frame switcher (192 inputs in HD, 48 in 4K), Evertz hybrid SDI/IP router (allowing 4K sent as a quad-HD signal today and IP in the future), several 12-channel EVS XT3 replay systems, a Calrec Artemis audio console, and ChyronHego 4K graphics.

39FLEX rolls with 12 Sony HDC-4300 camera systems with Fujinon 4K UHD/HDR lenses and deploys Sony's BVM-X300 4K/HDR master monitor.

Noted Garvin, "39FLEX can deliver a full 4K/HDR production, a rich HD one, and everything in between."

Implemented most recently in 40HDX and 40VMU, the two-trailer, dual-feed model allows both home and visitor to access all camera/replay sources with a dedicated truck for each.

"[It] has been a terrifically successful model," said Garvin. "Clients love it because [both shows] get a truck but the rate is the same as [having] the dual feed in the single truck. Some producers have even said that it's better than two completely separate trucks because all the sources and features of the home truck [are] totally accessible in the visit truck."

The unit, which launched Sept. 20, is based in the Orlando/Tampa market, primarily working Fox Sports Florida and Fox Sports Sun telecasts. When operating in dual-feed mode, 40HDX's Grass Valley 7M/E Kayenne K-Frame switcher is split: 4M/E for the home show, 3M/E for the visitor.

Although 40HDX/VMU is similar to two-trailer dual-feed predecessors in MTVG's fleet, its A unit is a double expando and has a third bench in the production room. Also, it boasts a larger complement of high-speed cameras, with a total of four Grass Valley LDX 86 Universe super-slo-mo cameras.

MTVG's 38FLEX (a 4K-capable version of the two-truck, dual-feed model) carries four Grass Valley LDX 86 Universe super-slo-mo cameras. Twenty-four of the company's 27 53-ft. expandos now have at least two super-slo-mos, according to Garvin.



39FLEX rolls with 12 Sony HDC-4300 camera systems.

The 40HDX A unit's control room features a four-stripe panel for the home show's 4M/E of the Kayenne K-Frame switcher (96 inputs/48 outputs). The production wall features 16 32-in. LCD video monitors capable of displaying up to 132 images.

In addition to the four super-slo-mo cameras with Grass Valley 3G fiber converters (SHEDs), 40HDX/VMU rolls with seven Grass Valley LDX Premier HD cameras with Fujinon lenses (one 99X and seven 77X long lenses and four ENG lenses) and a Canon 72X long lens.

On the replay side, 40HDX/VMU features four 12-channel EVS XT3 servers (with 16-channel embedded audio) and a four-channel EVS XS3 server for SpotBox (two channels per show on duals). The truck can run in SSMO mode (16 HD in/12 HD out) or HD mode (32/16). In either configuration, two XT3's can be split into two four-in/two-out operator positions.

40HDX's audio room features a Calrec Artemis Beam audio console (56 faders, 256 routable inputs via MAD1, 64 analog inputs, 64 analog outputs) and carries Sennheiser shotgun and stick mics and Sony lavalier mics.

Also aboard are a 378x802 Evertz 3G/4K router, 2752x2848 Evertz audio router (embedded audio, 32 AES pairs, 18 64-channel MAD1), RTS ADAM-M matrix intercom system (64 ports of OMNEO, 64 channels of MAD1, 48 analog ports), ChyronHego graphics (or rack-mount Vizrt graphics for Fox Sports Regional Networks shows), and 18 frame-sync/cross-converters (10 with fiber in/out).

40VMU's production room has a three-stripe switcher panel for the 3M/E assigned to the visitor show and a seven-rack monitor wall with 58 displays. The audio room houses a Studer Vista 1 (50 mono channels, 38 stereo channels) and deploys Sennheiser mics.

"The [model] has definitely come of age, but we continue with incremental innovation on every truck," said Director of Business Development Nick Garvin. "Whether it's adding more super-slo-mos, a third bench, or growing to a double-expando [trailer], we're squeezing more technology than ever into these trucks." 

# Work smarter

KVM and more for superior information-workflow

PREMIER SPONSOR  
**SVG**  
SPORTS VIDEO GROUP



## IHSE's next generation hybrid matrix switch builds on the strength of Draco tera flex-port technology

The Draco tera compact UNI matrix switch provides the option to switch any combination of 3G-SDI, USB 3.0, MADI and ultra-high-definition KVM using an SFP modular design. Each port is designed around the IHSE flex-port technology, which allows any port to be defined as an input or output. Frame sizes are available for eight, 16, 32, and 48 ports in 1 RU

- UNI Matrix for 3G-SDI, USB 3.0, and MADI
- A full line of video extenders for DVI, HDMI and DisplayPort up to 4K
- Ranging from 8 to 48 ports in 1U
- Network Control with SNMP
- API option for 3rd party control
- Redundant power option
- Larger frame sizes up to 576 with draco tera enterprise series



Learn more about our KVM integration  
with the AVID Pro Tools | S6

DISPLAYPORT | HDMI | DVI | VGA | USB-HID | USB 2.0 | USB 3.0 | AUDIO | 3G-SDI | RS-232 | RS-422

**IHSE GmbH - Headquarters**  
Maybachstrasse 11 88094  
Oberteuringen | Germany  
Phone: +49 7546 9248-0  
www.ihse.de

**IHSE GmbH - Asia Pacific Pte Ltd**  
158 Kallang Way, #07-13A  
Singapore 349245  
Phone: +65 6841 4707  
info@ihseapac.com

**IHSE USA, LLC - Americas, MEA, India**  
1 Corporate Drive, Suite F  
Cranbury, NJ 08512  
Phone: +1 732 738 8780  
www.ihseusa.com  
info@ihseusa.com

**ihse**  
USA



Canare develops, manufactures, and provides the best audio and video cables, connectors, patch bays, and fiber-optic products for the television broadcast industry and the professional A/V market. Broadcast engineers, sound technicians, A/V facility integrators, design consultants and many leading OEM's rely on Canare's product, proven reliability and top notch customer service.



Full line of Audio / Video connectors and cables for most applications.

BNC / Triax / Din 1.0/2.3 / SMPTE HFO

Most of our cables and connectors are 12G ready.

New quick connect 4-Channel 3G SDI connectors and panel mount.

For 4K applications where rack space is limited



Manufacturer of HFO SMPTE cable and connectors. We have standard lengths in stock with custom sizes and configurations assembled in New Jersey.

Great for studio or mobile application.



45 Commerce Way Totowa, NJ 07512 | [www.canare.com](http://www.canare.com) | 973-837-0070

[salesgroup@canare.com](mailto:salesgroup@canare.com)



# bioGFX

## broadcast biometrics from sensor to screen.

[biogfx.com](http://biogfx.com) | [fmproduction.tv](http://fmproduction.tv)

powered by

**FM-PRODUCTION**

The web is inexpensive,  
open source and awesome.  
Now live TV graphics are too.

**Open-source playout.**

Never pay for playout software again.

**Off-the-shelf hardware.**

Runs on machines you can buy in a store.

**Simple Interfaces.**

Train bug operators in about 5 minutes.

**Multichannel & Multilanguage.**

And control it all automatically with one operator.



POWERING

**UFC**

POWERING

**FOX**

POWERING

**FS1**

# NEP BROADCASTING

## WWE Embraces IP, Expands Footprint With Three New Units



By Jason Dachman

**W**WE produces *Raw* and *Smackdown* live on USA Network every Monday and Tuesday, respectively, as well as a dozen PPV events a year. Throw in the content needs of the burgeoning WWE Network, and it's easy to see why WWE had outgrown its NEP Red and Black and opted to roll out a trio of state-of-the-art production trucks.

"We can give productions the professional workspace and technical firepower that they deserve," noted Duncan Leslie, SVP, event technical operations, WWE.

WWE 1, 2, and 3 — NEP's third set of WWE mobile units since 2001 — house an Evertz EXE IP router, a Grass Valley Kayenne K-Frame switcher (192 inputs, 9M/E, two control panels), a 40-Gbps fiber backbone, and Dante IP-based audio/comms. Comprising two double expandos and a C unit and housing two control rooms and four audio-mixing rooms, the trucks carry three Sony HDC-4300 cameras operating at 240 fps and a battalion of Sony HDC-2500's (set to be upgraded to HDC-4300's) — all outfitted with new Canon lenses.

"We decided to go with [an IP router]," said Mike Grossman, SVP, television operations, WWE. "IP allowed expansion for larger shows and different types, and we also understood that was the way of the future."

The impetus for a new mobile unit was *WrestleMania*; one of the largest annual live productions in the U.S., it demands a growing arsenal of resources. Besides the PPV linear telecast and the live-streamed content, WWE's trucks produce the venue videoboard show.

WWE's non-stop schedule necessitated a seamless transition for the production team: the new trucks had to look and feel like Red and Black, with significantly beefed-up technology.

The domestic and international growth of WWE Network has drastically increased production needs both onsite and at WWE's broadcast center in Stamford, CT. Said Grossman, "The network requires a pretty significant amount of shoulder programming, and we also had to expand our production capabilities in terms of multi-linguaging."

WWE's trucks are NEP's third with an IP router, following SSCBS and SS24. Besides the Evertz EXE IP router, WWE relies on a 100%-fiber infrastructure throughout the trucks and into each venue and DANTE-based IP audio and comms. The unit features a 40-Gbps infrastructure within the trucks and 10-Gbps connectivity to drops throughout the venue. An enterprise-class Cisco network throughout the trucks enables the IT team to integrate with each venue more easily and manage the event.



NEP's WWE trucks feature a whopping four audio rooms.

"The IP router allowed us to put a lot of that router I/O remote and go right out of the router at each of these locations," said Joe Signorino, VP, systems integration, NEP. "You eliminate a lot of that baseband-to-fiber conversion and back to baseband at the other end, leaving quite a bit of flexibility."

The trucks also mark WWE's transition to a totally tapeless workflow. "The move from tape to tapeless," noted Glen Levine, co-president, U.S. Mobile Units, NEP, "was a joint venture of the guys in the field, our integration department, and their organization in Stamford."

A Thinklogical KVM infrastructure allows operators "any-to-any" access to and control of the slow-motion and instant-replay systems, the graphics systems, and other functions in the truck.

The A unit features a similar but slightly larger control room than in Red and Black, a significantly expanded graphics area (featuring Ross Video XPression graphics), recording, video, and EIC engineering. The B unit houses four audio rooms, the second control room, space for several flex positions, an A2 audio area, and dedicated workstations for media management and IT.

Increasingly incorporating slow-motion replay into telecasts, WWE opted to significantly expand the replay room, installing seven EVS XT3 servers, four EVS IPDirectors, and three EVS XTAccess systems. On the ENG side, an XFile3 restores Sony SxS ENG cards 10 times faster than real time.

The trucks' four audio rooms handle, respectively, main mix, submix, preshow mix (working with the secondary control room), and international feed. They house a Calrec Artemis console, two Calrec Apollo consoles, and a DiGiCo SD10B, respectively.

In addition to the WWE trucks, NEP built several trucks outside of North America in 2016 and also launched Turner Sports' TS2B production trailer, which can be used as either a straight unit or an expando. 





## WHEN GOOD ENOUGH JUST WON'T DO

The 2016 Summer Games in Rio was the site of groundbreaking performances – and not just by athletes. Ikegami was there with pioneering 8K coverage and the world's first 8K Outside Broadcast (OB) production vehicle. At the Games, it supported Ikegami's 4th-generation UHDTV cameras, the SHK-810, developed in cooperation with Japan Broadcasting Corporation (NHK). The world's first 8K ultra HD field camera system, the SHK-810 employs a single 33 million-pixel Super 35 CMOS sensor, achieving 4,000TVL horizontal and vertical resolution.



*"The Summer Games represent the ultimate in passion, excellence and achievement. Ikegami's commitment to these principles was highlighted by our extensive 8K presence in Rio in 2016."*



Hiroshi Akiyama, Marketing Division Deputy Director of Ikegami



800-368-9171 • [www.ikegami.com](http://www.ikegami.com)

**Ikegami**<sup>®</sup>



# Setting the Standard

For decades, Yamaha has introduced a number of innovations that have become industry standards. The CL and QL series of digital mixing consoles have continuously raised the bar adding new functions and workflow efficiencies to make your job easier. Often compared but never matched, Yamaha goes above and beyond with industry-leading training, service and support. Visit [yamahaca.com](http://yamahaca.com) to see what the standards are all about.



[www.yamahaca.com](http://www.yamahaca.com)

## Yamaha Commercial Audio Finance

*Take your production capability to the next level with a financing program worthy of the Yamaha name.*

[www.ycafinance.com](http://www.ycafinance.com)



# YOU ASKED FOR SINGLE-LINK 4K 12Gb/s



## WE DELIVERED

---

Utah Scientific's 4K enterprise router is the first of its kind in the industry and comes with a free 10-year warranty.

[www.utahscientific.com](http://www.utahscientific.com)

---

# FREE 10-YEAR WARRANTY

# PROSHOW BROADCAST

## Ovation Continues on Path To 'At-Home' Production



By Jason Dachman

As the at-home production model becomes increasingly significant in the live sports production, Proshow Broadcast has found itself in the middle of the action. Having launched in 2008 with a single SD truck, Proshow has embraced the growing REMI (remote-integration) production market by rolling out a fleet of six at-home-friendly mobile units ranging from a pair 40-ft. Gerling Stallion trailers to a trio of 24-ft. Mercedes Sprinter vans working for Pac-12 Networks. Proshow's latest mobile unit, a 27-footer dubbed Ovation, will debut just after New Year's and is based on the successful 27-ft. Opus unit that the company launched last year.

"Last year, we realized we had outgrown the Sprinter-van [model] on which we built the first three trucks for Pac-12 Network for their at-home [productions]," said Proshow President/founder Tim Lewis. "Clients were doing bigger shows that required more space, more cameras, more cargo, more cable, more everything. So we built Opus, which was the first of the new [27-ft.] design targeted at the at-home market but also capable of other [small traditional remote] productions."

Opus stayed busy throughout 2016 and received positive reviews from clients, leading the company to launch a nearly identical truck for 2017.

"We were really pleased how [Opus] worked out and hit the mark on what was needed," said Lewis. "It stayed very busy on college basketball and throughout the year. One of our major sports-broadcaster clients said it was the perfect REMI truck and absolutely loved it. That client has been encouraging us to continue to build along that model, as have other clients."

When launched in January, Ovation will be housed in a 27-ft. Gerling Super Nomad on a Peterbilt chassis and will feature a Blackmagic Design ATEM switcher and 72x72 video router. The truck will roll with six to eight Sony cameras with Canon lenses and will be wired for a six-channel replay system.

One element that will be different is audio and comms, which will rely more heavily on DANTE IP-based audio. Proshow began experimenting with DANTE on Opus (with an analog backup) but will expand its use in Ovation, which will feature a Yamaha QL-5 (72 channels, 32 faders) and RTS ADAM-M matrix intercom system.

"REMI trucks need to be very capable in audio and comms; video's pretty easy because you just pass back however many camera paths back and you're done," said Lewis. "A lot of digital DANTE integration is so we can do full-fiber audio, drops, and booth kits where we need to. It was a really good platform for that, so Ovation is building on that and even updating technology a little more."

Ovation will also feature Proshow's first purely fiber, DANTE-based booth kit. Lewis added that Opus and Proshow's trio of Sprinter vans (Busker, Solo, and Trouper) are likely to be retrofitted with DANTE-based infrastructure as the technology becomes more reliable.

"We've been leaving ourselves some safety net since you can never trust anything 100% in the first year; we had analog backup," he explained. "You go into an older venue that has no fiber and only has DT12, and it doesn't make a whole lot of sense to run 2,000 ft. of fiber just to do a fiber booth kit, so we have to leave ourselves some flexibility. But we're really looking at targeting copper [reduction] on our trucks to save on the weight limit. Fiber can go a long way in helping that out."

Vancouver, BC-based Proshow opted to build its seventh truck not only to keep up with the rising demand for at-home production but also to extend its geographic reach across the U.S.

"We've seen a lot of growth on the East Coast over the past year and felt that we needed to better support that region of the country," said Lewis. "Opus is based in Dallas for basketball season and primarily covering [the South]. With two units in Ovation and Opus, we will never be more than a couple of days' drive from where we need to get anywhere in the country."

Though designed primarily for at-home-style operations, Opus has also found business working smaller traditional remotes. 



Ovation is based on its predecessor truck, Opus (shown here).

# Exclusive Insights

## MPEG-H Prepares for Pyeongchang

By Fraunhofer IIS

**P**yeongchang will be a major milestone for the introduction of Ultra High Definition TV in Korea. Fraunhofer is pleased to announce the planned schedule for ATSC 3.0 broadcasts in South Korea:

**November 2016** Test broadcasts begin

**February 2017** TV sets on sale  
24/7 broadcasting in ATSC 3.0 with MPEG-H

**February 2018** All programs carried in ATSC 3.0 with MPEG-H

The MPEG-H TV Audio System, selected as the sole audio codec for ATSC 3.0 broadcasting in South Korea, will become the first next-generation audio codec to be used over-the-air and the first to be included in consumer TV sets. Fraunhofer continues to support the South Korean networks, professional equipment manufacturers, and broadcasters as pre-production continues for Pyeongchang.

MPEG-H is the next-generation system for interactive and immersive TV Audio. Visit [www.mpeghaa.com](http://www.mpeghaa.com) for more information.



# MORE THAN JUST CONNECTORS

COPPER CONNECTIONS



FIBER OPTIC SYSTEMS



WIRELESS SOLUTIONS



**XLR & plugs / speakON®  
powerCON® / rearTWIST® BNC  
etherCON® / opticalCON® / XIRIUM® PRO**

We are more than just connectors. We put our long time know-how and our whole passion into our innovative products and unique solutions. No matter whether a rock band or a lighting designer, an industrial application or a broadcast studio – Neutrik offers high quality and reliable solutions for every application. For more information visit [www.neutrik.com](http://www.neutrik.com)

**NEUTRIK®**

SETTING THE STANDARD

9

3

IN CONTROL, QUALITY  
& COLLABORATION

6

S ●●●●  
B ●●●●●

I N N O V A T I O N

& E X P E R T I S E

Y O U C A N

C O U N T O N

S I N C E 1 9 7 6

BUT WHO'S KEEPING SCORE

1.877.877.2269



[BLACKBOX.COM/BROADCAST](http://BLACKBOX.COM/BROADCAST)

# TNDV TELEVISION

## 4K-Capable Exclamation Is Largest in the Fleet

By Brandon Costa

Not too long ago, Nic Duggar, the founder and owner of TNDV Television, would have considered himself a healthy skeptic when it came to the advent of 4K/UHD. But something happened in late 2016 that changed his mind.

“Six months ago, I would have said nothing, dead, quiet, occasional, but very rare,” he said. “All of a sudden, the demand — at least the request for bids — ticked up pretty dramatically. As much as I wanted to dismiss [4K] as a stepping stone between HD and 8K, I’m starting to think that maybe it will catch on a little.”

Duggar booked four 4K shows for the final two or three months of the year. So it was a good thing that, back in June, TNDV rolled out its first fully 4K truck, Exclamation.

Exclamation, the eighth active truck in the TNDV fleet, offers quad-link 4K capabilities, with a Grass Valley Kayenne 4K-ready switcher (the first GV switcher in a TNDV truck), AJA Ki Pro recorders, and audio-production and -recording gear built around a Studer Vista X mixing console from Harman Professional Solutions. However, Duggar is quick to note that TNDV’s mission is provide mobile production facilities with highly customizable features.

“The way that we approach our entire fleet is that we don’t lock a spec list down to any one truck,” he explained. “Clients all the time ask us to send them a spec list, and we can’t. I ask them, ‘What do you want? Do you want eight cameras or 18? Do you want one long lens or 12?’ We build truck packages per show, per client, and our inventory is liquid. It’s different every show.”

A major driving force behind the decision to build Exclamation was size. TNDV was founded in the early



*Exclamation, TNDV’s first fully 4K truck, offers full 1080p broadcast and production support.*

2000s when Duggar saw a hole in the mobile-production marketplace: midsize facilities. Support for four- or five-camera shows was hard to find at the time, and TNDV began a successful business catering to the needs of those clients.

By 2015, Duggar had realized that he was having to turn business away simply because clients were asking to fit significantly larger crews into his trucks. So TNDV got together with Gerling and Associates to draw up a blueprint for a truck that would maximize capacity for more bodies. Exclamation can hold up to 30 seated people.

“That sounds like an impossible number to fit inside a truck,” he laughed, “but we do it all the time. The additional floor space that we’ve added makes such a huge difference.”

Exclamation is the first unit in TNDV’s fleet to offer full 1080p broadcast and production support with 24-frame-per-second capability, and the GV Kayenne switcher provides up to 192 inputs and 96 outputs of native 1080p support, with the ability to support 4K productions upon request.

Exclamation worked its first event in June — the Walmart shareholders meeting — which doesn’t sound like much, except that it was a multiday event welcoming 10,000 attendees into a full-size professional sports arena. Since then, the unit has worked the Dove Awards, a big 17-camera show celebrating the year in Christian and gospel music, as well as a 4K-transmission test with DirecTV at the Country Music Association (CMA) Awards in early November. 

*TNDV’s newest mobile unit can accommodate up to 30 people.*







*KY-PZ100W pictured with optional Verizon LTE modem and RM-LP100 controller*

# Infinite Possibilities

## Acquire from the world. Deliver to the world.

Now broadcast quality HD images can be acquired remotely from and be delivered to anywhere there is an IP connection. The **KY-PZ100** is the world's first PTZ camera to provide true IP connectivity via 4G-LTE, and can also integrate into Wi-Fi®, LAN and other industry standard infrastructures.\* The KY-PZ100 also features 0.01 Lux sensitivity, remote operation from smart devices, on-board recording onto microSD/XC media, FTP capability and a smooth and efficient direct-drive mechanism. Providing the ultimate PTZ control is the **RM-LP100**, the world's first IP-centric remote camera controller which can command the movement of up to 100 cameras and store 100 preset positions. Pristine 1080 60P/I H.264 video can be streamed wirelessly to CDN's via RTMP, or securely encoded to the ProHD BR-DE800 decoder with SDI output. The revolutionary PTZ IP Camera System from JVC Professional — its possibilities are infinite.

Learn more by visiting [pro.jvc.com/ptz](http://pro.jvc.com/ptz).



KY-PZ100W

KY-PZ100B



All brands or product names may be trademarks and/or registered trademarks of their respective owners.  
\* 4G-LTE and Wi-Fi require optional adapters.

# LEADER

## LT4610 Test Sync Generator



- Two 3G/HD/SD-SDI Outputs
- Test Pattern : Multi Format Color Bars, Checkfield
- Genlock & 6 Independent BB/Tri-Level Sync Outputs
- Character ID, QVGA Logo Insertion & Safety Markers
- Audio 16 Ch.via SDI + AES/EBU, Silence, Word Clock
- Redundant Power Supply
- **GPS and Time Code Option (LT4610SER01)**

[www.leaderamerica.com](http://www.leaderamerica.com)

# Monitoring in a Hybrid World

Facilitate the move to IP at a pace that suits you with TSL Products' award winning solutions.

## Bridge the interface gap

No matter the application or location, our highly reliable and customisable products are designed to integrate seamlessly in to hybrid SDI/IP workflows where existing standards interoperate with the new and provide a cost-effective solution to becoming IP-ready.



### MPA Range

Compact, ease of use audio monitoring, featuring SDI, Analogue, MADI, DANTE, AES67 and HYDRA2 Inputs.



### PAM-IP

Smooth the transition to IP with Video over IP (S2022-6 & S2110), Audio over IP (Dante / AES67), 4K and Dolby decoding, as well as SDI/Analogue and AES.



### TallyMan

Advanced broadcast control capable of controlling hybrid SDI/IP systems.



OB TRUCKS



STADIUMS



LIVE PRODUCTION



STUDIOS



Contact our international sales team today to find out more:  
[www.tslproducts.com/wheretobuy](http://www.tslproducts.com/wheretobuy)

E: [enquiries@tslproducts.com](mailto:enquiries@tslproducts.com) | T: +44 1628 564 610



# TOKEN CREEK MOBILE TV

## New Pioneer Offers High-End Footprint at Affordable Price

By Jason Dachman

As high-profile live sports productions demand more trucks and advanced facilities than ever and budget-conscious lower-end college and regional events look to smaller trucks and the “at-home” production model to meet their needs, a sweet spot has opened up in the middle of the market for providers of mobile-production facilities. With that in mind, Token Creek Mobile Television has launched Pioneer, a 53-ft. single-expando mobile unit that meets the production and budgetary demands of the mid to small market while providing the capacity of a high-end show.

“I think [Pioneer] is perfect for that mid market,” said Token Creek President John Salzwedel. “It’s designed especially for regional small-market stations that want the physical space but at the right price point. There are lots [of truck providers] out there with Sprinter vans and horse trailers, and they all serve a very important purpose, but a lot of our clients want the physical space in the truck to operate and not feel like they’re cramping a whole big crew into a vehicle for six people. Pioneer [is a real bonus] for those kinds of clients.”

Token Creek elected to build Pioneer when it won a multi-year contract for a college-football and -basketball package with a television station in the Dakotas. This package, along with a handful of MMA shows, will keep Pioneer busy through the spring.

“We [will be] running up and down I-29 until March covering college football and basketball with Pioneer,” said

*Pioneer, which was integrated in-house at Token Creek’s shop in Waunakee, WI, features a 3M/E Grass Valley Kayenne switcher.*



*Pioneer aims to meet the demands of the mid/small market.*

Salzwedel. “It will also be doing several MMA-style events, which we’re very excited about.”

Although the truck is intended to work traditional productions, it does have the capability — and price point — to flex into at-home/REMI-style production if called on.

“Pioneer is priced at a point where those budget-conscious clients that would like the big truck can afford it,” said Salzwedel. “It’s absolutely a step above the REMI-level trucks, but the price structure allows it to go that route if we need to. It is not [purpose-built] for REMI shows, but we would definitely be able to if that situation comes up.”

Pioneer, which was integrated in-house at Token Creek’s shop in Waunakee, WI, is built around a 3M/E Grass Valley Kayenne switcher and GV Trinix router. The audio room features a Calrec Artemis console, and the replay area houses a six-channel LSM EVS XT3 replay server and a Grass Valley K2 Solo media server (at the request of the client). The truck rolls with 10 Grass Valley LDX 80 Series cameras with Fujinon lenses.

“The layout is a little bit different than what we’ve done in the past,” said Salzwedel. “When you walk in, the switcher faces the opposite direction of what you traditionally see in the truck. It’s just the way the layout ended up working out, but the client is very happy with it.”

The fourth truck in Token Creek’s fleet — joining Sioux, Chippewa, and Varsity — Pioneer marks the company’s first new build since Sioux launched in 2014. In addition to building Pioneer, Token Creek upgraded all of its trucks to Grass Valley Kayenne switchers over the summer. 



# FOCUS ON FLEXIBILITY



Based on models originally developed for use in the Summer Games, Audio-Technica's BP4027 (14.96") and BP4029 (9.29") Stereo Shotgun models are engineered for high-end broadcast and production use. These innovative microphones give sound recordists the remarkable flexibility of selecting a left-right stereo output (wide or narrow) via the microphone's internal matrixing system or choosing discrete Mid-Side signals for later manipulation. Whatever your audio demands, listen for more.

[audio-technica.com](http://audio-technica.com)

 **audio-technica**  
always listening



ACQUIRE • MANAGE • DISTRIBUTE • ARCHIVE

## CENTERPOINT™ - NEXT GENERATION ASSET MANAGEMENT

Complete Solution from Acquisition to Archive

Location Intelligence: Studio or Remote, Local or Cloud



Multi-Resolution

Multi-Frame Rate

Multi-Codec

Multi-Channel

Always Recording

All in Real Time

**ONE ENCODER**

[WWW.PRONOLOGY.COM](http://WWW.PRONOLOGY.COM)



F@RSCENE

MAKE YOUR VIDEO CONTENT

**WORK HARDER**

Create digital highlights packages in 2 minutes.

Closed caption ready out of the box.

**INCREASE REACH - INCREASE ENGAGEMENT - INCREASE REVENUE**

**MAXIMISE PRODUCTIONS IN OUR CLOUD**

[WWW.FORSCENE.COM](http://WWW.FORSCENE.COM) | [COMMERCIAL@FORSCENE.COM](mailto:COMMERCIAL@FORSCENE.COM)

# VIACOM MEDIA NETWORKS

## 4K-Capable Atlas Debuts, Along With Three Units for Spike Sports

By Jason Dachman

It was a busy truck-building year for Viacom Media Networks, which rolled out the massive, 4K-capable Atlas for its Music and Entertainment Group and a trio of units for its Spike Sports shows.

The Atlas A and B units debuted in January for Fox's *Grease Live!* telecast and has served as production hub for the MTV Movie Awards, VMAs, and other large live shows. Atlas is built around a Sony XVS-8000X switcher and a Utah Scientific 400 Series 2 1156x1156 3G baseband router (the company is waiting until IP technology matures, according to George Epley, senior VP, technical and production operations, Viacom Music & Entertainment Group). The B unit's audio room houses a Lawo mc<sup>2</sup>66 MKII with 80 faders.

Atlas features an entirely tapeless workflow with 10 Sony PWS-4500 production servers and 24 channels of Pronology mRes multiresolution encode/record systems (soon to be 32). Running on the Pronology media-asset-management system, the mRes records an uncompressed high-res file, an edit proxy, and a live-streamable proxy in real time for each SDI input channel. The proxies are fed to the postproduction team at MTV's facility in Manhattan, streamlining the editing process. The high-res files are recorded to Small Tree TitaniumZ-5 40-TB hard drives, transported manually to the facility.

"The integration with postproduction is key," noted Epley. "[Previously], our normal protocol was [to record] clean program, dirty program, backup, and then iso every camera; that would be 32 or 33 tape machines for [a show like the VMAs]. Now we are doing hundreds of streams in different file formats."

Because Spike Sports productions are growing in both number and size, Pegasus A and B and edit truck Gracie were rolled out in the spring and will have worked 20+ events by year's end.

"We knew that Spike Sports should have its own trucks," said Scott Fishman, SVP/executive producer, Spike TV. "It just made sense from a volume standpoint and gave us the ability to move forward with new technology."

Viacom gutted its existing Pegasus 53-ft. double-expando and single-expando trailers and built the Spike Sports trucks. Integrated by BeckTV, Pegasus features two complete production rooms and audio rooms, one of each per trailer. The A unit houses a Grass Valley Kayenne 4M/E switcher (80 inputs/48 outputs) and a Calrec Apollo audio console; the B unit, a 2M/E switcher and a Calrec Summa console.



Atlas B unit's audio room houses a Lawo mc<sup>2</sup>66 MKII with 80 faders.

The trucks roll with 13 cameras: three Sony HDC-4300L's for high-frame-rate and 4K/HD-cutout applications and 10 Ikegami HDK-55's. Pegasus carries three EVS 12-channel XT3 replay servers and a four-channel EVS SpotBox (total 40 replay channels). Two Sony PWS-4500 servers drive the 4K/HD-cutout workflow.

"As we were planning, the thing that had become obvious to me — regardless of the distribution aspect to the consumer — is that 4K has become a great production tool [for HD shows]," said Epley. "That is most obvious in sports, particularly [combat sports] because there are so many extreme close-ups. So part of the design concept was to bring in as much 4K as we could as a production tool."

Also aboard are Ross Video XPression graphics and RTS ADAM intercom. Monitor walls in both trucks comprise Boland 4K displays powered by Grass Valley Kaleido MX multiviewers. The three audio rooms (including Gracie's) are connected via Calrec Hydra II network.

Gracie essentially serves as a postproduction house and connects the edit team in the field with Spike headquarters for access to its entire content library. Integrated in-house, the 51-ft. double expando features three Adobe Premier Pro edit stations (running on MacBook Pro 2's with 43-in. Sony 4K client monitors) and a 256-TB Small Tree TitaniumZ-16 NAS running on a redundant 10GbE network (provided by Juniper Networks EX4550 10GbE switches). The audio-control room houses a Calrec Summa console, a 64-channel Avid Pro Tools editing system, and a voiceover room.

Spike ingests 1080i content via Pronology's mRes multiresolution encoder, which records three tiers of uncompressed video per SDI input channel: a high-resolution media file, an edit proxy, and a live-streamable proxy. 4K content is ingested natively into the servers and passed to the edit team for 4K cutout in post. 



# Make every screen a front row seat.

*Deliver broadcast quality video to any device, anywhere, every time.*

 **Limelight**  
NETWORKS

Sports fans always want to see a great performance. But when they are catching the action online, it's not just the athletes who need to deliver.

Your viewers expect a fast, flawless digital experience. No buffering. No stuttering. No interruptions. Give them what they want with the Limelight Orchestrate™ platform, a powerful, cloud-based video delivery solution that ensure a seamless, broadcast quality experience on any device, anywhere, every time.

[www.limelight.com/broadcast](http://www.limelight.com/broadcast)

+1.866.200.5463

©2015 Limelight Networks, Inc.

# The world's first mobile daylight touchscreen broadcast system.



PGA Tour, 2016



UEFA EURO 2016, Paris, France

## Put your sports analysis where the action is and bring your fans closer to the game

SmartCart SVX is a highly innovative outdoor mobile interactive touch screen system designed for live production use by TV Sports Broadcasters worldwide.

## SmartCart's versatile and mobile applications are great for

<b>Broadcasters</b>	Studio hub for presentation analysis and stand-up interviews
<b>Teams</b>	Pitch side coaching hub
<b>Stadiums</b>	Entertainment hub and sponsorships

## SmartCart has already delivered at the following world class events

<b>Golf</b>	PGA Tour, European Tour, Ryder Cup
<b>Soccer</b>	UEFA Euro 2016, Premiere League, UEFA Champions League
<b>Football</b>	NFL International Series
<b>Cricket</b>	Investec Ashes, Tests, ODI's, CWC
<b>Rugby</b>	Champions Cup, Autumn Internationals
<b>Racing</b>	Formula 1

## Contact us today to learn more

Phone U.S.: (646) 863-6263  
Phone EMEA: +44 773 4138 545  
gil@SmartCartSVX.com  
www.SmartCartSVX.com



**GET INSIDE THE GAME.**



**STAND OUT** *from the crowd...*

*it's the* **FLORICAL WAY**

What is the Florical way? It is treating every customer as a partner and not a dollar sign. It is excellent customer service. It is superior innovation. It is creating software that works. It is a laser focus on your needs for automation and playout.

For over 30 years Florical Systems has been leading the television automation marketplace with the most innovative, proven, and reliable technology in the industry. Florical offers the best in disruptive technology such as Channel-in-a-Box (Acuitas), cloud-based control (Smart Central), award-winning file-based content distribution (FlashForward), creating a holistic ecosystem to manage every aspect between Traffic and playout. Florical software is simple, economical, flexible, and scalable from single channel to multi-site, multi-channel distribution and playout.



**FLORICAL SYSTEMS®**

[FLORICAL.COM](http://FLORICAL.COM)

© Copyright 2016, Florical Systems. All Rights Reserved. Florical and its trademarks are registered trademarks, while all other marks are the property of their respective owners.



**BROADCAST GRAPHICS SERVICES**

DESIGN | INTEGRATION

**DATA PLATFORM PRODUCTS**

NEWS & SOCIAL | WEATHER | SPORTS | FINANCE | ELECTIONS

[www.astucemedia.com](http://www.astucemedia.com)

Montreal +1.514.903.6159    Dubai +971 (0)4 445 8479



# Brand Brigade

▶ **Pioneers in Virtual Advertising  
and Virtual Product Integration**

Discover untapped  
advertising opportunities!

▶ [www.brandbrigade.com](http://www.brandbrigade.com)



**Proud  
Corporate  
Sponsor**

# THE TOOLS YOU NEED CONNECTED



CAPTURE    PRODUCE    MANAGE    DELIVER

**Do you need to know more about utilizing the cloud? Is 4K in your future? Struggling with how to bridge your facilities?**

Dynamic Media Management integrates what you have, with what you need. Primestream's FORK™ and Xchange™ suite of software seamlessly integrate the capture, production, management and delivery of all of your assets for workflows as far ranging as traditional broadcast to OTT.

Learn more at [primestream.com](http://primestream.com)



D y n a m i c   M e d i a   M a n a g e m e n t



3g is a broadcast-industry leader in RF technology, providing video and audio solutions as well as exceptional customer service since 2002. For 2016, 3g expanded its capabilities dramatically with new on-board camera systems; proprietary POV cameras, including helmet, ref, and ump cam; 1080p RF capabilities; and IP video solutions. 3g continually looks to stay out in front by seeking and implementing the latest technologies to deliver higher quality and cost savings to its customers.



AVS is a leader in wireless HD and aerial production with more than 70 RF HD systems by Vislink/Link Research, including the compact Link L-1700 and four GoPro HEROcast systems. AVS has four gyro-stabilized Cineflex camera systems and two Partenavia fixed-wing aircraft for aerial coverage. Its engineers recently won another two technical Emmy Awards for Los Angeles Dodgers baseball and Super Bowl 50. AVS was the first to integrate Sony's P-1R into an RF Steadicam system, with video return and prompter, that became the preferred package for *Dancing With the Stars*, *The Voice*, *America's Got Talent*, *So You Think You Can Dance*, *Little Big Shots*, *Shark Tank*, *Maya and Marty*, *Grease: Live*, *The Wiz*, *The Passion Live*, *Thursday Night Football*, and the Academy Awards and other major award shows.



AerNow is a technology and digital-media company building an all-new way to connect audiences everywhere with video content and live events. It enables:

**Capture:** Easily integrate any digital content into the AerNow ecosystem.

**Publish:** Upload content to the AerNow network from your desktop, AerNow's virtual master control (AerControl), live feed, or broadcast network.

**Engage:** Activate fans with all-new digital experiences, POV switching (through AerBox and AerControl), social feeds, UGC, and one-stop engagement.

**Expand:** Increase awareness, drive views, and expand audiences with built-in distribution and syndication technology that connects your content with the viewers you want.

**Automate:** Ensure feature and update control across mobile, game, TV, and web devices with new ease and ROI.

**Monetize:** Bring the revenue home with full-feature advertising, subscription, PPV, VOD, merchandising, ticket, VIP, syndication, and other business-building features — on your terms.



Now in its 18th year of business, Alliance Productions is a strategic collaboration of the largest group of mobile-production companies covering North America.

In August, Alliance Productions held its 10th-annual

Technology Expo in Indianapolis. A wide variety of broadcast-industry vendors attended the summit and displayed their latest technology and equipment. Alliance partners and selected invited guests from within the mobile-production industry were able to spend high-quality one-on-one time with the vendors to learn more about their product lines and make requests for future purchases.

Alliance Productions can provide expertise in live sports and entertainment productions, corporate events, news events, religious broadcasting, and webcasting on local, regional, national, and worldwide telecasts.



Clients everywhere enlist Alpha Video to help them engage fans and enhance teams. In the Live segment, the company completed control-room upgrades to HD for T-Mobile Arena, Churchill Downs, Target Center, Florida State University, and the University of Central Florida, among others. The company also completed work on U.S. Bank Stadium, the world's most technologically advanced sports venue, and is working closely with the Atlanta Braves on the new control room at their new home, SunTrust Park, scheduled to open next year. In the Team segment, Alpha Video completed the A/V systems at the University of Kentucky's new Football Training Center and is working with several other clients on upgrading their team facilities. In the View segment, the company's CastNET Sports digital signage and IPTV solutions were deployed at the MTS Centre, Target Center, and Florida State University.



AVDS is a national provider of broadcast and pro-A/V design and integration services. A leader in engineering, design, consulting, project-management, custom-fabrication, system-support, and post-installation services, it has been providing solutions and services to major media and entertainment companies across the U.S. for more than 35 years.

AVDS regularly teams with the industry's best designers and fabricators and works independently to supply its clients the best video-display solutions available.

Headquartered in Lumberton, NJ, the AVDS team brings Emmy Award-winning expertise and professional integrity to every client engagement. The company comprises a talented and responsive team of engineers, highly skilled in a full spectrum of professional A/V services, including specialized development and support for broadcast facilities, command and control centers, and corporate lobbies.



Azzurro TX is a solution for sports clients seeking bidirectional transmission from locations where traditional long-haul fiber connectivity is not available. The company provides broadcast-quality low-latency transmit and receive over the public internet. The system is easily transported in a TSA-certified carry-on case.

The standard system includes two encoders and two decoders, enabling transmission of multiple cameras or outputs from a production truck, as well as simultaneous reception of two sources, such as program and prompter. Two VoIP dialtones are included for communications, such as IFB and PL.



## VPMS

Enterprise-Class  
Media Asset Management

- Enterprise-class Workflow Orchestration & Integration
- Ingest, Edit, Archive, Distribution
- Multi-Site & Multi-Language
- Logging, QC, Review & Approval, Studio Production tools

## EditMate

Collaborative Editing  
& Project Management

- Editing Collaboration for Adobe® Premiere® Pro CC
- Search, Import, Ingest, Check-In
- Proxy or HiRes editing, Background conforming and transfer
- Project management templates and system administration
- Optional VPMS MAM integration

CONNECTING  
CONTENT  
& PEOPLE

All the steps of the way, Arvato provides you with the best possible solutions – turning your viewers into excited fans.

Arvato Systems | Email: [media-us@arvatosystems.com](mailto:media-us@arvatosystems.com)  
Phone: +1 866 413-3622 | [IT.arvato.com/broadcast](http://IT.arvato.com/broadcast)

**arvato**  
BERTELSMANN

Arvato Systems - Empowering Digital Leaders.





# The Right Relationship



For nearly 60 years Dale Pro Audio has served the Broadcast, Post Production, Studio Recording, and Live Sound / Installation markets with distinction.

Dale carries the industry's top brands, stocks thousands of products in Queens, New York location, and is staffed by sales professionals second to none.

We have decades of experience selling to the Broadcast market, and partner with our clients every step of the way. You can put your trust in us, because gear is only part of what we deliver.

**Because relationships matter.**

# *Congratulations to the*

# SPORTS BROADCASTING HALL OF FAME

# *Class of 2016*



ANDREA BERRY



JOE COHEN



VERNE  
LUNDQUIST



TIM MCCARVER



SEAN  
MCMANUS



BOB MIKKELSON



ROBIN ROBERTS



DAN ROONEY



CRAIG SAGER



BILL WEBB

## INDUCTION CEREMONY December 13, 2016

New York Hilton Hotel, Trianon Ballroom

[www.sportsvideo.org/halloffame](http://www.sportsvideo.org/halloffame)

# Your venue hosts lots of winners.

Let's make your wireless  
network one of them.

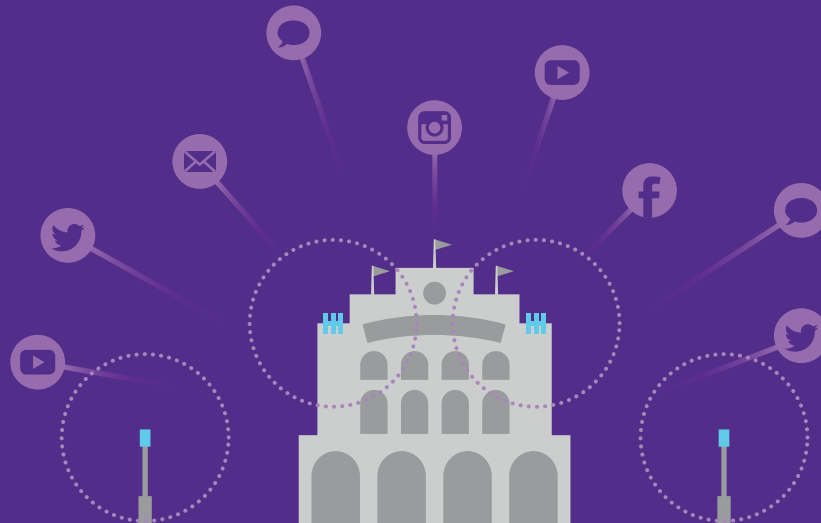

Your biggest crowds have big wireless voice and data needs. With 15 years of small cell solutions experience, we know how to make sure you're ready. We'll design a network that meets the wireless and aesthetic needs of your venue, and build it in a way that accommodates multiple wireless carriers. So no matter what the score on the field, you'll always be winning in the stands.

**Speak to a dedicated venue specialist by calling 724.416.9120 or emailing [Venues@crowncastle.com](mailto:Venues@crowncastle.com).**

**The Foundation for a Wireless World.**

[CrownCastle.com](http://CrownCastle.com)



Azzurro HD's 24/7 Network Operations Center can remotely configure and manage the system to offer a complete plug-and-play experience for non-technical operators. Azzurro TX can be used anywhere a public-internet connection is available. It is currently deployed at sports venues for live shots on the field as well as for offsite press conferences and awards ceremonies.



BeckTV has steadily built a reputation as a premier sports-television systems-engineering and integration firm. Its growing portfolio of sports-related work comprises projects for college and professional teams alike. Current and recent clients include Notre Dame, Cleveland Indians, Tampa Bay Buccaneers, AT&T Center in San Antonio, Dr. Pepper Ballpark, and Dick's Sporting Goods Park for Kroenke Sports. Related projects include turnkey solutions for mobile-production trucks for such prominent clients as IMSP, MTV, Game Creek, Turner, and YES.

BeckTV offers comprehensive services for anyone needing broadcast-television expertise, and the company provides customers with a one-stop shop for all their television-facility and system requirements. Its forward-thinking design and engineering ensure that future distribution and monetizing methodologies are fully recognized and incorporated into clients' solutions. BeckTV services include space planning, design, engineering, equipment purchasing, technical-furniture fabrication, and wiring and integration.



Bexel provides a comprehensive range of rental solutions with notable expertise in scalable live-production systems, specialty cameras, fiber-optic solutions, graphics, and wireless audio and communications. This summer, the company provided more than 125 cameras and seven flypacks for Rio 2016. It also integrated IP technology to increase the flexibility of the systems between events. Bexel continues to expand its 4K offering with new cameras and processing equipment.

The most significant addition in 2016 was the Clarity Camera line of custom-built cameras by Bexel, starting with HD in 8X. In 2017, 4K at 2X will be available in a variety of small-form-factor specialty cameras designed as a complete system for live production.

Bexel ESS is the company's systems-integration division focusing on venue facilities and remote enterprise video solutions. It continues to grow rapidly, with an exclusive contract in 2016 to upgrade 31 stadiums and arenas across the U.S.



At its 20th Olympic Games, BSI provided technical engineering and management services at top venues for Rio 2016. Concurrently, it brought PBR (Professional Bull Riding) to Canada for its inaugural tour. BSI diversified to include live streaming and its Airpack for Amazon's venture into videogaming. BSI's broadcast-rental department continues to expand, providing video-commentary systems to the international broadcasters covering the World Series. BSI now offers fully licensed and insured drone facilities, capable of providing HD and 4K video.



Continually leading development and integration of next-gen, cutting-edge RF technologies and exclusive turnkey solutions, BSI has been a dominant provider of wireless (RF) technology and commu-

nications systems for television broadcasting for more than 30 years. It provides microwave transmission and custom remote-controlled miniature camera systems to the broadcast industry, delivering point-of-view coverage across a range of applications. BSI takes its expertise to the highest level with highly skilled teams of design engineers, manufacturing technicians, and operations personnel.

From concept through design and manufacturing to turnkey service, BSI takes live broadcast productions from ordinary to extraordinary. It tailors audio, video, and communications packages to meet the unique needs of every customer and backs its technology with first-class, onsite customer support.



Founded in 1986, Calhoun is the oldest, continuous provider of transportable earth-stations in the U.S. The company has grown significantly throughout the years, always maintaining the highest level of customer service and attention to detail.

Calhoun's inventory includes two dual-dish C/Ku-band trucks, three Ku-band trucks, one C-band truck, and one Ku-band trailer. Housed between Miami and Pittsburgh, Calhoun's trucks have easy access to a wide geographic area throughout North America.

As a gateway to the Caribbean, Calhoun has floated trucks to many island locations as needed. Specializing in high-profile live special-event productions, the company's mobile units can be seen at major sports and news events throughout the country.



Calient Technologies is a global leader in pure photonic optical-circuit switching. Broadcasters and content providers are continuing the rapid adoption of optical fiber. Production crews need to efficiently manage an increasingly complex fiber infrastructure in order to share and rapidly access high-value camera-control units and media servers. A key benefit of Calient's S-Series switches in production environments is the ability to automate and remotely manage fiber-rich environments regardless of protocol.

Calient's S-Series optical-circuit switches are now integrated with the MAGNUM Controller from Evertz. The integration allows production facilities that use MAGNUM for facility management and control to enjoy the protocol transparency and significantly lower cost and power consumption of pure optical-layer switching. The optical-circuit switch can be thought of as a very fast and highly reliable software-controlled optical patch panel. After initial connection and setup, all subsequent reconfiguration is handled remotely via MAGNUM.



CES provided event power and temperature control for some of the summer's biggest sports events.

In May, the second-annual Invictus Games were held at the ESPN Wide World of Sports Complex in Orlando. Created by

STORAGE CREATED TO SIMPLIFY MEDIA WORKFLOWS

# BUILD YOUR STORY ON DELL EMC



Your foundation for today's media workflows, future-proofed  
for tomorrow's business opportunities.

Find out more at:  
[emergingtechsolutions.com/media-entertainment](http://emergingtechsolutions.com/media-entertainment)

**DELL**EMC

# MASTERING MEDIA WORKFLOW



Enabling Sports Organizations to Maximize the Value of Media Assets by Providing Software-Based Solutions to Better Create, Manage & Distribute Content



## ROUTE66 – THE ROUTE TO SUCCESS



New **AUTO-ROUTING** and **INTELLIGENT FIBER PATCHBAY** functionality added by OPTOCORE to well known BroaMan Route66 video router.

Perfect for installed systems with multiple connection points (stage and different mixing positions) and mobile devices.

**DESIGNED AND MANUFACTURED IN GERMANY**



Broadcast Manufactur GmbH  
inquiry@broaman.com



Britain's Prince Harry, the Paralympics-style multisport event relied on CES's expert technicians and technologies for power.

In June, CES supplied nearly 3 MW of redundant power and nearly 1,000-kVA UPS backup for the Copa America Centenario. Consisting of 32 matches, the international men's association football tournament was held at 10 venues across the U.S.

This summer also marked the second year that CES provided generator power and technical services for Fox Sports USGA golf broadcast. CES then revved up for the 2016 football season by expanding its UPS inventory, allowing broadcast projects to reduce their carbon footprint without compromising the security of redundancy.



CBT Systems is a worldwide broadcast-television and video-production design, engineering, and integration firm whose commitment to the industry is demonstrated in its knowledge, experience, and confidence. The company has built a reputation for providing systems of the finest quality and performance and has completed projects demanding imagination, innovation, and precision. CBT Systems' combination of skills allows it to provide clients with event and live-production facilities unparalleled in the industry.

The hallmark of the company's success is its emphasis on understanding client programming and operational demands coupled with development of a first-class system and facility in a timely, efficient, and cost-effective manner. CBT Systems' team comprises dynamic and dedicated professionals each with a common set of goals: quality work, personable relationships, and client satisfaction.



In today's media landscape, where content is king, Chesapeake Systems provides sports and media organizations the storage capabilities and collaborative video-workflow solutions they need.

The company sees the big picture. It knows there are scores of individuals involved in shooting, editing, sharing, and archiving tremendous amounts of footage, which needs to be immediately accessible. As an IT-centric media-systems integrator, Chesapeake Systems is prepared to provide the right workflow solution. Its experience runs the gamut from collegiate sports to the NFL, and it has built strong relationships with many leading hardware and software vendors to help meet all your needs.



CineSys-Oceana specializes in high-end workflow solutions and support, including storage infrastructures, tiered storage solutions, archive, backup management, and more.

There is increasing demand for sports broadcasters to ingest, edit, and review high-quality material on location quickly. The microDDP is a silent, fast, and lightweight Ethernet SAN storage solution well-suited to OB work. microDDPs have been used at large sports events, including the 2016 Rio Olympics.

The LEM-250A is a 24.5-in. Full HD 10-bit reference OLED monitor. Combined with TVLogic's video-processing and color-calibration technology, the LEM-250A gives the highest picture quality and professional features required in the most color-

critical work environment.

IHSE's Draco Ultra is the first 4K DisplayPort KVM extender. It enables monitor, keyboard, and mouse to be up to 10 km from the CPU to provide a quiet and clutter-free work environment.



Clark Media provides rentals of HD production trucks and broadcast equipment, including custom-built HD and 4K production systems. The company has a full-time staff of rental managers, engineers, and production professionals ready to provide outstanding support for your next project. Its locations in Burbank, CA, and New York City facilitate service nationwide. With a call to Clark Media, a client can discuss its needs, and the company will provide the gear with crew and see clients on location. Clark Media's goal is to let its clients concentrate on the big picture and let it handle the technical stuff.



CMG Mobile operates the state-of-the-art 48-ft. Integrity HD mobile-production unit. Its standard equipment complement features a Grass Valley Karrera K-frame switcher, NVision HD router, GV LDX Premier cameras with Fujinon lenses (Integrity is wired for up to 16 cameras), a Miranda multiviewer system, a Yamaha PM5000 audio console with a fiber booth kit, two EVS XT2 replay servers with an EVS XFile3, and ChyronHego Duet HyperX3.



CEI is an award-winning consulting, design, systems-integration, and equipment-sales and -service company in Newington, VA. The company represents more than 500 of the media industry's most valued equipment manufacturers for project integration and direct equipment sales. CEI also operates a large service and support organization, available to the sports-media industry nationwide, from its Service Depot in Virginia to its onsite field repair and maintenance services. Its service engineers receive regular industry training and authorized certification to keep pace with new products and technologies.

Sports-media professionals need the latest digital equipment and expert services they can rely on — and that starts with a proven and affordable service provider. CEI is an energetic, highly motivated team, focused on the success of customers' projects. The company welcomes the most challenging technical issues of today's sports-media projects to prove why CEI can always be relied on.



CP Communications

CP has been providing solutions for audio and video communications for more than 30 years. Since opening in 1985, the company has been supplying leading-edge-technology rentals and custom-engineering solutions while providing top-quality service. CP has the most comprehensive up-to-date digital-equipment rental inventory in the industry. The company's equipment and services include aerial video, custom engineering/design/build, custom fiber-optic networks, HD wireless camera systems, HD RF mobile productions, frequency coordination, mobile or fixed microwave systems, and wired and wireless audio, video, and communications.

CP can provide a turnkey production solution or a box rental, each will be custom-designed based on the needs of the



# Live & Local



## LIVE WIRELESS NEWSGATHERING

  
**LIVESHOT**



**COMREX** USA

BROADCAST RELIABLE

### Live remotes reinvented.

LiveShot™ is the ideal solution for delivering live HD video and audio from the field to the studio over the public internet. Focus on the story knowing that Liveshot is monitoring your 3G/4G services and adjusting your data feed in real-time across the networks. Lightweight and portable with separate return video, two IFB channels and full-duplex intercom/cue channel - it's the whole remote package.

**GET THE SHOT.**

[www.comrex.com](http://www.comrex.com)  
[info@comrex.com](mailto:info@comrex.com)

**CONTACT US.**

1 800 237 1776  
1 978 784 1776



Building a Secure Future.™

# Upgrade your defense with Irdeto 360 Security

- Forensic watermarking
- Automated detection
- Real-time enforcement
- Cyber investigations



[www.irdeto.com](http://www.irdeto.com)



# VITEC IPTV & SIGNAGE SOLUTION

1 VENUE – 10,000 SCREENS – 1 SOLUTION



SEE US  
AT SVG  
SUMMIT

client and the wants of the production, and the company will always approach them with the same level of professionalism that has come to be synonymous with the CP Communications name.



2016 was a banner year for Burbank, CA-based CMSI, which received a Sports Emmy for its contribution to Fox's coverage of the FIFA Women's World Cup 2015. Other events throughout the year — including U.S. Open golf, NBA Finals, and The TED Conference — also benefited from CMSI's expertise. The company continued its commitment to providing efficient and custom tapeless-workflow design; Avid, Premiere, EVS, Cisco, and Cinedeck rentals; and international on-location support.

Whatever your production size, from four cameras to 4K, CMSI's team designs and supports your custom solution.

## CSP | MOBILE PRODUCTIONS

CSP Mobile Productions has been a pioneer in remote production for nearly 30 years. Since 2011, it has continued to build out its fleet to serve ESPN, Fox Sports, CBS Sports, NBC Sports, and more. CSP currently runs a fleet of four 53-ft. HD units and a B unit throughout the country, totaling around 500 events a year.

CSP has capitalized on the growth of rugby in 2016. The company has been the main provider for many international matches for USA Rugby, AFL regular-season and postseason and NFL preseason football, MLS soccer, Little League Baseball, and a variety of boxing and MMA bouts. CSP has also entered into a new agreement with ESPN for the 2016 college-football season. For the rest of 2016, it will be working often with Fox Sports, CBS Sports, and ESPN in college football and basketball.



CTG brings extensive experience, resources, and know-how to each client. Its quality approach has been consistent: provide the very best audio/visual and broadcast solutions.

CTG designs, integrates, installs, and maintains individually tailored systems. Regional and national in scope, the company offers a complete suite of products and services to businesses large and small.

CTG assures its customers high-quality service, technical expertise, and professionalism as a Certified AudioVisual Solutions Provider (CAVSP) through InfoComm International. CTG's abilities in providing project and integration services across the U.S. are further strengthened by its affiliation with Professional Systems Network International (PSNI), an international alliance of premier audio/visual-systems integrators.



Digital Comm Link services the television-broadcast industry as full-service video-, voice-, and data-transmission company, offering a wide range of services from C- and Ku-band satellite communications to ISP, co-location, and teleport services.

Digital Comm Link owns and operates two HD/SD Ku-band dual-path satellite trucks, each capable of 1080p, 1080i, and 720p with 16 channels of audio. The company also operates 14 HD/SD

studio live-shot and playout facilities used primarily by sports and news networks throughout Florida.

In response to ever growing demand for HD broadcast-quality video via IP transmission, Digital Comm Link developed and deployed the DigiCaster-managed IP transport platform, which delivers live bidirectional H.264/MPEG-4 ASI/SDI streams via the public internet without the need for fiber, point-to-point, or DIA circuits.



Focused on the fan experience, Diversified amplifies game-day excitement by designing and delivering expertly engineered and integrated sound, video, and networked broadcast systems. Evidenced by NBC Sports Network's broadcasting of the Olympic Games and in football venues — Hard Rock Stadium, AT&T Stadium, and Levi's Stadium — across the nation, Diversified's portfolio includes 60+ large-scale integration projects. They range from control rooms and A/V solutions to managed networks and include the design/build of 12+ sports networks and 30+ large-scale mobile units.

Diversified provides expert consultation, implementation, and management for every aspect of communications. Diversified IT, video, and rich-media professionals shape the delivery of content to ensure that it passes quality control before reaching the public, separating the technology from delivery of the desired message.

## dna music labs

DNA recently built and launched its fifth mobile-production truck, HD28. An integral part of the company's fleet, HD28 houses five GV cameras, including a super-slo-mo unit. It has a 2M/E Carbonite switcher with Ross XPression graphics and four channels of replay (plus one channel of super slo mo). The 40-channel digital audio desk with full routing ability makes audio a snap. A fiber booth for audio and HD video makes setup easy. A 28-ft. straight truck, this unit is suitable for its regional sports clients and even "at-home" setups. Innovation continues to drive the company's commitment to its clients. DNA Studios has a complete line of production facilities, including a 53-ft. expando truck, flypacks, and even a new 3,000-sq.-ft. TV studio.



For applications from video-control rooms and edit suites broadcasting corporate communications worldwide to state-of-the-art commercial broadcast and production facilities, professionals turn to Duncan Video for complete evaluation, design, integration, and installation of today's advanced telecommunication equipment.



DX3 Media recently inked a multiyear deal to provide host-broadcast services to Infront Sports and Media for the Lake Louise Alpine Ski World Cup in Alberta, Canada.

Working with Program Productions and IMS Productions, DX3 Media was charged with providing the host-broadcast services, including crew, cameras, production vehicles, craft services, and more. More than 60 staffers were onsite during the event; 20 of those staffers were camera operators.

IMS Productions provided the 20 cameras and its HD1 production truck, and additional gear were rented through Western



# Streaming Video Amplifies Fan Engagement

IBM Cloud Video





VISIONARY SET DESIGN  
MOTION GRAPHIC DESIGN  
LIGHTING DESIGN  
CELEBRATING 30 YEARS



FXGROUP.TV / GIANTOCTOPUS.COM (407) 877-9600

# imagen<sup>o</sup>



Archive

Organize

Customize

Monetize



## Relive the dream

Imagen helps sporting organisations to preserve and monetize their growing video libraries

### Long-term preservation

Best in class archiving, workflows and cataloguing tools keeps your content safe and ready for the future.

### Monetize your media

Easy to configure Subscription VOD and B2B licensing features enable content owners to generate revenue through a secure, branded platform.

### Searchable and customizable

Elegant and intuitive web interfaces for powerful search and retrieval via a customizable website. Play, edit, download and share your media.

### Controlled access

Customers, staff, public or private, Imagen gives you full control over who can access your content and what they can do with it.



FROST &  
SULLIVAN

Global Digital Asset Management  
Entrepreneurial Company  
of the Year 2015

iabm  
DESIGN & INNOVATION  
AWARDS - 2016  
WINNER

streaming<sup>™</sup>  
media magazine

Streaming Media European  
Readers' Choice Awards 2015  
Media Asset Management



Jib Productions, Fletcher, and VER. RF Wireless provided all the RF technology and personnel, which was essential for transmitting signals from the top of the mountain to the production compound.



Encompass is a global technology-services company focused on supporting sports leagues, TV networks, broadcasters, and digital leaders with the delivery of linear/nonlinear video content across television and digital platforms. The company designs, implements, and operates reliable video solutions that capture, process, and deliver clients' video content from any source in any format to any destination in the most efficient and reliable way possible. Encompass's global connectivity, scalable technology infrastructure, and strategic partnerships create a single, synchronized content-delivery environment. Reach additional markets by streaming your live events online and deliver to any screen. Daily, Encompass services 850+ channels; captures, processes, and delivers 25,000+ hours of TV/OTT; streams 3,000 hours of TVE/OTT content; and acquires/distributes 250+ live events for its clients worldwide via its eight facilities across four continents. Services include global transmission and connectivity; channel playout; OTT/TVE streaming and VOD; live events; and disaster recovery.



Summer 2016 saw many upgrades to the entire F&F fleet; the biggest changes were made to the GTX-11 and B-1. GTX-11 started its Fox NFL season opener with its new customizable monitor wall, switcher upgrades, audio upgrades, eight-channel EVS servers and new XFile3, and a 10-gig network, as well as a complete rewire and the addition of 40 HD reclocking DAs. The B-1 was rebuilt and now features five 70-in. 4K monitors with multiviewers and customizable work space. These upgrades make the B unit a perfect work space for graphics overflow, streaming, robo camera, and editing. In addition to the upgrades, F&F dedicated time and resources this summer to redesigning and rebuilding its engineering workshop to accommodate the company's expanded engineering team and to focus on segmented work space for preventive maintenance to enhance and maintain its growing fleet of mobile units.



September was a full one for the Filmwerks team. The crew introduced two UPS (uninterruptable power supply) touring systems: one for WWE Network, the other for CBS/NFL Network's *Thursday Night Football* package. Both systems were custom-built for the clients' specific tour power needs and offer each redundant power using a UPS system.

WWE Network hit the road in Memphis, TN, with a trailer custom-designed by Filmwerks' engineering team. The trailer features two 350-kW generators as well as a 400-amp UPS system to support both an A and a B unit.

Filmwerks also helped kick off the *Thursday Night Football*

season for CBS/NFL Network, providing a UPS system for the weekly production. The company designed, engineered, and fabricated a custom box for the *TNF* tour with an 800-amp UPS system, nine tons of air-conditioning, and a small office space.



Fletcher Sports typically has busy summer seasons, but Rio 2016 brought July and August to another level. Several employees traveled to Rio de Janeiro to oversee more than 60 camera setups, including I-MOVIX, NAC, and Sony equipment. Added to the mix was Fox's debut coverage of golf's U.S. Open, which deployed Fletcher robotic systems with Sony HDCP1 cameras at each tee box. Fletcher has also acquired several new Sony HDC-4800 slow-motion systems, which are being deployed for NBC and CBS NFL coverage this fall.



With more than 20 years of experience in mobile-production-unit design, Gerling & Associates provides workmanship for domestic and commercial markets. Broadcasters trust the company's systems integrity to produce the Super Bowl and a wide variety of sports events.

The company's services include all interior and exterior design, custom mobile solutions, complete refurbishment warranty and maintenance, finish custom carpentry, and much more.

Gerling has built 90% of all remote-production trucks and trailers fielded in North America. An independent, family-owned and -operated corporation, Gerling is located in Sunbury, OH, and its plant houses more than 140,000 sq. ft. of production space for the custom design, manufacture, and integration of our vehicles.



2016 marks the 15th anniversary for ID, which has grown significantly over the years. The company specializes in redundant power for television broadcast and events as well as professional lighting, deploying both conventional and automated fixtures. It is a member of ARRI Rental, which provides camera, lighting, grip, and generators to the motion-picture industry worldwide. It has locations in Los Angeles and Charlotte, NC, as well as access to multiple ARRI Rental locations. ID's broadcast division has been a significant contributor to the company's success, providing redundant power, lighting, and crew to events in many geographic regions. Currently, ID's broadcast division is busy with *Monday Night Football*, college football, supercross, boxing, and soccer in Cuba while ID's automated-lighting division is equally busy with *The Voice*, Blizz-Con, and The Latin American Music Awards.



Inertia Unlimited, known for moving the art of live sports broadcast forward with innovations like the X-Mo high-speed camera system and remarkable point-of-view cameras like Gophercam and Dirt Cam, has continued to innovate throughout 2016.

Inertia successfully introduced the Marvin robotic camera system, which can be operated locally or anywhere in the IP-linked



# Live Clipping from Anywhere

Without having to be at the live event or in a studio.



# Setting the Standard. Again.

## The New **LU600**



**H.265 HEVC**  
**Upgradable**

Exceptional Performance.  
Exceptional Speed.

- Highest video quality and bitrate:  
up to 20Mbps
- Fastest file transfer for FTP/S&F modes:  
up to 80Mbps\*
- Lowest end-to-end delay:  
0.5 second\*
- High speed bonded internet capabilities:  
up to 100Mbps

Visit [get.liveu.tv/lu600](http://get.liveu.tv/lu600) for more information



\*Available in version 6.5/7.0

E V E R Y

M O M E N T

— DREAM — CREATE — INTEGRATE — EXCITE —

M A T T E R S

[DAKTRONICS.COM/GAMEOPSMOMENTS](http://DAKTRONICS.COM/GAMEOPSMOMENTS)



universe. The controls will be familiar to any traditional camera operator, eliminating the need for a specialized operator.

At IBC 2016, Marshall Electronics introduced the CV-RCP-100, a touchscreen RCP camera-control system developed and manufactured in-house at Inertia Unlimited. It provides remote control of all functions of Marshall and several other brands of cameras.



IMT employs a highly skilled staff of engineers, project managers, and workflow specialists that provide scalable technology solutions for business operations for sports and broadcast. The company's clients include sports networks, leagues, teams, and broadcast organizations, and its work affects virtually every aspect of an organization's operations and future multimedia ROI opportunities.

IMT collaborates with clients to design, build, implement, and deploy state-of-the-art file-based workflows. These workflows allow broadcast- and sports-operations personnel, including editorial, graphics, and postproduction teams to share and archive content.

IMT addresses the following major market sectors: broadcast television, media and entertainment, information technologies (IT), education, and telecommunications. The company will always design, build, and maintain technology systems that deliver optimum results for clients.



JMTV is a proud partner in Alliance Productions and currently operates its HD mobile unit, Visions HD, from its field shop in North Little Rock, AR. Visions is a 53-ft. HD expando unit featuring a Grass Valley Kayenne switcher, multiple EVS replay servers, and Sony cameras. JMTV is available for local, regional, and national events and recently provided facilities for ESPN and CBSSN in Alaska and Puerto Rico.



The St. Louis Cardinals selected Kaufman Broadcast to coordinate and manage a multimillion-dollar renovation of the Busch Stadium scoreboard. The original video screens and control room were upgraded to HD, including a fully HD distribution system. Kaufman has supported engineering services for the Cardinals since 1995.

Major League Baseball was also a perfect environment to test IP encoding, the latest technology to be embraced by Kaufman. Several spring-training games were transmitted over a private MPLS network for analysis of video quality and network integrity. IP encoding was also deployed for Fox Midwest pre/postgame coverage of the first three rounds of the NHL Playoffs.

Transportable C/Ku-band uplinks were upgraded to support newly created paths for at-home/REMI productions. With 10 encoders and three returns, sports networks embracing this growing production style have a variety of options for each unique broadcast.



KMH, formed in 2005, is a full-service systems integrator provid-

ing end-to-end solutions for broadcast and postproduction as well as for the retail, financial, and education segments.

KMH's subject-matter experts deliver the highest quality of personalized service coupled with unmatched flexibility during all phases of each project engagement. With more than 100 years of combined industry experience, the company offers its clients expertise in the areas of turnkey file-based workflow for digital-asset-management systems, as well as project planning, architectural coordination, project management, complete systems specifications, and integration, including design and engineering, staging, installation, programming, testing, commissioning, maintenance, and support. KMH also offers customers specialized training to ensure complete familiarization with the technology.



Kodiak Mobile Television is a full-service mobile-production company located in Broken Arrow, OK. Its mobile unit, Grizz HD, was designed and built to be a compact, efficient HD unit while providing the production tools that clients require. The 45-ft. trailer has a three-bench production area and audio, tape server, and video/engineering in different rooms. At less than half the weight of a 53-ft. trailer with no need for a B unit, Grizz HD offers fuel savings and reduced crew expenses to save clients money. Grizz HD is equipped for sports, entertainment, and corporate shows, and its 10 KiPro Rack units suit it for posted shows. Also aboard Grizz HD is a Panasonic ENG camera package and Apple Final Cut Pro or Avid editing.



LH is a reseller specializing in video-storage solutions for the media and entertainment market, including professional and collegiate sports. Its solutions offer next-generation storage platforms, providing content production, distribution, and archive with the performance and reliability needed to meet extreme production and delivery deadlines. The company offers solutions with proven file systems, optimized for video, in an end-to-end solution from ingest to archive; they are designed for performance from the ground up and built on the foundation of providing high-performance collaboration to leading post and broadcast organizations. LH has a variety of manufacturers to draw from in providing direct attached storage, FC SANs, as well as traditional NAS to meet demanding workflow needs. Trust a partner like LH Computer Services that has a history of architecting and providing solutions to clients in the NBA, NCAA, and more.



Little Bay, a supplier of trucks and trailers, built a 20-ft. production trailer to add to the Thistle Communications fleet. The company also had a new opportunity over the last year to work on an OTT service.

For Major League Lacrosse, Little Bay built a control room and got its operation off the ground, which has been a resounding success. Currently, Little Bay has a project to help UMass Lowell meet its America East commitments and feed its videoboards.

ORACLE®

DIVA

# PRESERVE. MANAGE. PROTECT.

Creating and Recreating Unforgettable Experiences

Oracle DIVA is the **GLOBAL LEADER** in **CONTENT STORAGE MANAGEMENT SOLUTIONS** that ensure smart storage and easy access to your assets.

Oracle has created the **FIRST ENTERPRISE-GRADE PRIVATE-CLOUD** content storage management solution.

Oracle DIVA is the **TRUSTED PARTNER** for 3 of the 4 **LARGEST SPORTS LEAGUES** in the United States.



FIND OUT MORE



Integrated Cloud Applications & Platform Services

Copyright © 2015, Oracle and/or its affiliates. All rights reserved. Oracle and Java are registered trademarks of Oracle and/or its affiliates. Other names may be trademarks of their respective owners.



DELIVERING THE

# MOMENT

With virtually every major sporting event in the world using Nevion equipment to deliver sports' defining moments, making the switch to a true, standards-based IP infrastructure could not be in safer hands.

Nevion's proven IP solutions for contribution and for studio infrastructure deliver the features and performance to enable a smooth and cost-effective transition to IP media production.

**Technology available now.**

Talk to the experts today:

Phone: +1 212 380 0550

Email: [ussales@nevion.com](mailto:ussales@nevion.com)

[nevion.com](http://nevion.com)

**nevion**

15 YEARS OF DELIVERING  
THE BIGGEST  
SPORTS  
EVENTS  
IN THE WORLD



*Proven Success@Scale*

iStreamPlanet.com (888) 702-7873

A Turner Company

Owned by the father-son team of Brian and David Raynes, Little Bay offers a combined 60 years in the business and is well-suited to working closely with its customer base. Located in Dover, NH, the company's facility is large enough for many multiple projects.



Lyon Video provides mobile television-production facilities, equipment, and event crewing for a wide variety of sports and event clients. Recently, it was chosen to provide host-broadcasting and multiple international-rights-holder services, including 4K content, which was fed to a number of rightsholder networks and stations for use in their own coverage.

Lyon Video has found that more and more clients are looking for 4K content, especially in sports and entertainment, where differentiation is key. 4K content enables a better viewing experience in the right circumstances, and the company is always ready to increase capabilities to meet client needs.



Markertek's SMPTE, opticalCON, and tactical fiber cables have earned the trust of live-production broadcasters with ongoing installations in premier sports venues worldwide. The Markertek fiber lab is the only shop to earn certification by LEMO, Canare, and Neutrik opticalCON. The company is ready to supply all cable, reel, patch-panel, breakout-rack, and wall-box requirements.

Markertek's mobile-video team has 15 years of experience building reliable production trailers offering a convenient, SUV-towable solution while saving thousands compared with an OB truck.

On-time delivery and free shipping make Markertek a go-to source for fiber extenders, converters, and production switchers. Take advantage of its award-winning customer service. Clients that partner with Markertek are assigned a dedicated sales engineer for personalized sales and service.



From the runways of New York Fashion Week to the hardwood floor of the Pac-12 Conference, with stops in between for Alpine World Ski Championship Coverage in Colorado and MLB Spring Training coverage for the Arizona Cactus and Florida Grapefruit Leagues, Metrovision continues to provide a full slate of production and transmission services for a diverse group of clients nationwide. It offers a full spectrum of media and production services, including mobile and live event production as well as Ku- and C-band satellite transmission services.



MPS currently operates three mobile units from its home base in Columbus, OH. MPS Hiawatha is a 53-ft. HD straight truck, fully equipped with a GV Kalypso switcher, multiple EVS replay servers, and Thompson cameras. MPS Sterling, an SDI expando, is capable of 16:9 and an excellent solution for internet and webcasting, as well as legacy SD shows. MPS is available for bookings on sports, entertainment, corporate, or religious events.



Production Resource Group has provided production support for some of the world's most prominent sports events: Olympics Opening Ceremonies; Super Bowl halftime

shows; the prestigious Longines Masters equestrian events; and video, lighting, and scenic support for emerging eSports events. In 2016, PRG supported the Polartec Big Air at Fenway event in Boston in February, where athletes from around the world competed on a 140-ft.-high snow ramp for two days of snowboarding and freeskiing in the middle of the historic Fenway Park field. As athletes tore down the jump, PRG lit the way, providing white-light LED and PRG Best Boy Wash units for the NBC-broadcast qualifying competition. For the Longines Masters of Los Angeles, PRG overcame some unique challenges to create a successful show, including loading in enough equipment to span 12 football fields and then lifting that out of the way while the 8-in.-deep dirt footing was created.



Program Productions was recently ranked No. 3,617 on *Inc.* magazine's 25th annual Inc. 5000 list, an exclusive ranking of the nation's fastest-growing private companies. This is the 10th consecutive year that Program Productions has made the list, beginning in 2007. The list represents a comprehensive look at America's independent entrepreneurs.

Program Productions is a leading provider of live-event-production support and labor-management services. Headquartered in the Chicago area, with offices throughout the U.S. and North America, the company has experienced 86% growth in sales between 2013 and 2016.

According to Program Productions, the growth that it has experienced and the accompanying accolades symbolize the company's passion: the passion employees have for the work they do, the passion clients have for creating incredible experiences, and the company's passion to continue innovating within the industry.



Since 1979, PSSI Global Services, along with Strategic Television, has specialized in the coordination, production, and distribution of domestic and international programming. Backed by a skilled team of more than 47 broadcast engineers and 15 project managers, PSSI is a leading provider of mobile satellite transmission, production and streaming services.

PSSI offers a full range of fixed, mobile, and international flyaway satellite systems that provide live video, audio, IP, and data services worldwide. The company currently owns and operates more than 45 Ku-Band and C-Band satellite uplink/production trucks — more than any other transmission services provider — based throughout North America, as well as international and domestic C/Ku flyaway uplink systems.

Committed to staying at the forefront of technology, PSSI provides 10-path "At Home" transmission services for events across the globe and 4K transmission on major pay per view services.



Raycom Sports owns and operates two HD mobile units and two HD Ku-band uplink trucks. The RHD1 and RHD2 HD mobile units are 53-ft. expandos equipped for multilevel productions and housing Grass Valley Kayenne switchers, Calrec audio consoles, nine Sony HDC cameras, Canon lenses, up to 20 channels of EVS replay, Evertz routing systems, ChyronHego Duet HyperX3, and virtual-monitor walls. Each will operate on either fiber or triax.



# Back to the basics,

- ✓ **Shared Storage Solutions**  
SAN, Scale-Out NAS and  
file system management  
with HyperFS
- ✓ **Post Warranty Support for:**  
EMC/Isilon, NetApp, Brocade,  
QLogic, HPE, HDS, Dot Hill, Cisco,  
and many more . . .
- ✓ **Expertise in:**  
IP-based, Cloud, 4K,  
and UHD workflows

Scale Logic's solutions are in use in  
the NFL, NHL and D1 College Sports.



Provide a true  
live OTT  
experience

and make the most  
of your content



# FIS BLUE

Your Premier Broadcast Fiber Optic  
Manufacturer and Supplier!



With over 25 years of experience in fiber optics, FIS Blue has the ability to offer products and services for the stringent demands that broadcasters require.

Everything from bulk cable to SMPTE cable assemblies and SMPTE test equipment to SMPTE tool and cleaning kits, FIS Blue has your solution.

- ▷ Full Fiber Optic Cable Offering
- ▷ SMPTE-Ready Cabling and Test Equipment
- ▷ Fastest Lead Time on Cable Assemblies in the Industry
- ▷ Large Inventory of Products for Immediate Shipment
- ▷ Custom Manufacturing
- ▷ Great Selection of Fiber Optic Cleaning Kits
- ▷ Technical Support
- ▷ Repair Service



Tel: 315-768-8179  
[www.fisblue.com](http://www.fisblue.com)

Toll-free: 877-347-0091  
[info@fisblue.com](mailto:info@fisblue.com)





**RealityCheck**  
SYSTEMS

Earlier this year, RCS announced that it has taken an equity stake in Singular and is collaborating on development of Singular Live, a next-gen platform for OTT graphics delivery. The new platform is designed to facilitate creation and distribution of personalized viewer experiences across a range of devices with tailored graphics — from language localization to targeted advertising and interactivity. An open and flexible cloud-based architecture enables creation, management, and deployment of the graphics.

This summer, RCS also designed and delivered a custom graphics- and data-integration production solution for Perform's DAZN OTT sports subscription service, which launched in Germany, Austria, Switzerland, and Japan in August. Taking real-time sports data from Perform's Sport Data API, RCS's Foundation data-management solution parses relevant information and powers informative graphics templates tailored to each market, which are distributed to each live DAZN program feed.



RoboVision is a designer of robotic pan-tilt camera systems for broadcast television. The company pioneered the use of robotic camera systems at Daytona International Speedway in February 1990. Soon, robotic cameras became a part of every major sports, news, and entertainment event. Super Bowls, Olympic Games, and many major sports championships have been covered with RoboVision robotic cameras. RoboVision's Emmy Award-winning staff has the experience and determination to provide its clients with a world-class product.



Rock-It Cargo is a world-class company in specialty-freight forwarding and logistics. With more than 200 employees in 17 offices across the U.S. and around the world, it can handle all international, time-sensitive, fragile, and complicated freight moves. Originally specializing in entertainment and events, Rock-It has expanded its business into many industries that need the same special care and personal attention that the music industry has depended on for 35 years.



With a new generation of cost-effective, full-service, remote-production vehicles, Ross Mobile Productions (RMP) delivers consistent, high-quality video and audio content from sports and other live productions, and ensures a predictable production experience and outstanding results — all the time, every time.

Based on Ross Video's innovative openTruck model, RMP trucks feature powerful, compact broadcast systems from Ross Video and other leading technology vendors that are highly interoperable and have been designed to work together seamlessly.

RMP trucks can stream content to the web at the same time as it's aired live on TV or recorded for future airing. For clients who require additional production support, RMP provides a graphics package, score bug, and full pre/postproduction.



Saunders Electric provides high-quality power service to the entertainment industry. The company has developed a repu-

tion for its pursuit of excellence and maintains and pursues its mission to be the highest-quality power company on a daily basis.

Saunders Electric has been providing reliable portable power for live broadcasts and Hollywood productions since 1952. The company was awarded a Technical Emmy for development of the synchronous power system. Family-owned and -operated, it is a leader in energy-saving systems and is an alternative-energy partner with Sandia National Laboratories.



With the MLB All-Star Game playing in its backyard this summer, San Diego-based Satellite Digital Teleproductions and its HDLA 40-ft. expando mobile unit were called up to bat by Fox Sports San Diego. Following this successful stint, SDTV took HDLA offline for a much-needed upgrade.

HDLA first hit the road in 2008 as a fully HD mobile unit. The truck featured a first-generation Sony switcher and two six-channel EVS replay servers. SDTV opted to replace the aging switcher with a Grass Valley Kayenne switcher and upgraded to EVS XT3 servers, XFile3's, and a four-channel SpotBox.

HDLA is wired for eight Sony HD cameras with HD lenses and typically supports six- to eight-camera productions. Serving such clients as Fox Sports West, ESPN, CBS Sports, Showtime, and HBO Sports, HDLA typically serves high school football, college basketball and baseball, boxing, and many more sports events.



Skycam/Cablecam is a leading designer, manufacturer, and operator of mobile aerial camera systems. The Skycam and Cablecam systems are based on a sophisticated, computer-controlled cable suspension system that supports, stabilizes, and allows three-dimensional movement of a camera to capture overhead video of major events. Putting the viewer right in the middle of an event, the use of aerial cameras has significantly changed the way sports and other entertainment programming are broadcast both domestically and internationally by delivering angles and revealing perspectives that dramatically enhance the quality of coverage.



SMT provides clients with scoring, statistics, virtual insertion, graphics, and messaging for live broadcasts and events.

This year, SMT is bringing fans back to the stadium with its expanded in-venue solutions, providing the same data-rich graphics, virtual enhancements, and reliable clock-and-score technology that fans have come to rely on when watching their favorite teams on TV. With its Video Production Services (VPS) team, SMT offers a level of technology and services unavailable anywhere else in the sports market.

Fans also stay up-to-date with real-time sports, news, social media, and election messages via SMT's ticker system. The core technology behind SMT's data integration is its Data Matrix Switchboard (DMX), which ingests scoring systems, arena scoreboard feeds, third-party feeds, and social-media channels and integrates the data into graphics for videoboards, social-media walls, tickers, and virtual solutions.



WHO KNOWS WHAT  
MOMENTS WILL  
MATTER?

No timeouts necessary with Spectra's  
BlackPearl® Deep Storage Gateway.

Easy to use, BlackPearl saves time with its user-friendly interface, allowing sports video content to be quickly and easily found and retrieved. With BlackPearl's policy-based system, you simply set up your archive, leaving time for more important things - like rooting for your favorite team.

Visit [spectralogic.com](http://spectralogic.com) to learn more.



© 2016 Spectra Logic. All rights reserved worldwide.



# TAKE YOUR FAN EXPERIENCE OVER THE TOP

Keep your fans engaged wherever they may be with rich, interactive OTT video experiences that only Ooyala technology can deliver.

Leading sports broadcasters, teams, leagues and franchises the world over trust Ooyala for media logistics, video streaming, viewer analytics and monetization — for any business model.

Reach, measure and monetize your audience across all screens.



[www.ooyala.com](http://www.ooyala.com)





## FAN ENTERTAINMENT

*(CONCOURSES & PREMIUM AREAS)  
COMBINES LIVE ACTION WITH DYNAMIC  
CONTENT FOR FANS AND SPONSORS*



## DIGITAL MENU BOARDS

*(CONCESSIONS & TEAM SHOPS)  
PROVEN TOOL TO INCREASE SALES AND  
UPDATE CONTENT ON-THE-FLY*

# FanConnect

## INFOGRAPHICS AUTOMATION

*(CONTENT GENERATION)  
CREATE AND DISTRIBUTE STUNNING VISUALS  
ON IN-VENUE SIGNAGE AND SOCIAL MEDIA*



## SOCIAL MEDIA DISPLAYS

*(ENGAGE IN-VENUE AND OVER WEB)  
DISPLAY FAN TWEETS, POSTS AND PHOTOS  
IN EYE-CATCHING WAYS*



### ABOUT US

FanConnect provides a suite of affordable cloud-based solutions focused on sponsorship and the distribution of digital content for live sports events. Our unique ability to leverage both RF and IP infrastructure allows nearly any venue to enhance the fan experience and produce significant ROIs instantly.

2401 Carmel Executive Park Dr  
Charlotte, NC 28226  
T: 704.313.0399  
[www.fan-connect.com](http://www.fan-connect.com)



sonovTS provided detailed system design, planning, delivery, installation, and operation of the entire ORF broadcasting and production technology for the IBC at the 2016 Rio Olympics and associated TV studio, which was located at Ipanema Beach in Rio de Janeiro. ORF had six permanent venues connected to the IBC, including Austria House. Additionally, ORF operated an Ipanema Beach studio from the IBC via remote production. The connection took place, depending on the bandwidth available, in J2K or H.264. A team of 10 people from sonovTS was onsite for 4½ weeks for setup and de-rig and commissioning and production. More than 10 tons of equipment was transported to Rio de Janeiro from Munich.



SOS Global had the privilege to work on many high-profile events in 2016 — Rio 2016, Invictus Games in Florida, the Copa America Centenario (throughout the U.S.), and a double event held in Cuba: the U.S. presidential visit and MLB game — and many annual events: X Games, NFL Super Bowl, US Open tennis, British Open, Australian Open, and NBA and MLB games.

The events were planned and organized by teams in the U.S., UK, Germany, and Russia and moved efficiently and as planned. The offices are simultaneously being updated on new regulations and procedures to handle the 2018 FIFA World Cup in Russia. Planning for the 2017 Confederations Cup and 2018 World Cup includes onsite teams, air-charter flights, and door-to-door budgeting, planning, and execution.



The Switch's Pop-in-a-Trailer brings high-bandwidth, redundant, and diverse service offerings to previously unserved places. Each 22-ft. trailer is equipped with a NetInsight Nimbra 680, fully redundant trunk interface, and video and Ethernet interface cards, as well as redundant switch and node controllers. Each trailer can handle a minimum of eight inbound/outbound video or ASI paths and up to 16 Ethernet or internet connections. Trailers also feature monitoring and outboard test equipment. Trailers are equipped with a Honda Eu7000is gasoline generator, true sine wave output, and remote start and auto-transfer, powering three APC 3000VA uninterruptible power supplies. Trailers also feature two 1,000-ft. spools of TAC-8 fiber, four pairs of 3G-SDI Telecast Rattlers, three 200-ft. spools of Belden 1694A RG-6 coax cable, and two 200-ft. spools of dual Belden 2412 Cat 6 Ethernet cable.



Based in Springfield, MO, TL Mobile Television joined Alliance Productions as a partner to provide mobile television facilities throughout North America. The company's state-of-the-art 51-ft. expando mobile unit, HollywoodD, rolls with a standard equipment complement featuring a Grass Valley Kayenne switcher, a Miranda NVision HD hybrid router, Grass Valley LDK 3000 cameras with Angenieux lenses (HollywoodD is wired for up to 10 cameras), a Miranda multiviewer system, a Calrec Omega audio console, three EVS replay servers with 14 channels of LSM available, an EVS XFile, and ChyronHego Duet HyperX3.



Canada is leading the 4K charge in North America, and Unity Systems Integration is providing the push. Working with top Canadian broadcasters Rogers Sportsnet and Dome Productions, Unity has supported the end-to-end design and integration of 4K/ UHD live-to-home broadcasting.

Beginning with Dome's latest mobile unit, Pioneer, Unity produced the first purpose-built 4K truck in Canada. Pioneer is equipped to facilitate a 16-camera, 12-EVS-server production in both 4K and HD.

The Rogers facilities in Toronto include a 4K master-control and ingest room. The broadcast systems are based on 4K technology using an SQ (Square division Quad-split) or quad-link-based video-routing infrastructure, which is HDR-ready. Using uncompressed video lines from the Rogers Centre, Sportsnet will broadcast all the Toronto Blue Jays 2016 home games in 4K.



Rio 2016 went live in Brazil, Argentina, and the Caribbean, thanks to VER's broadcast systems and support. Delivering 15+ hours of daily content per network, simulcasting to both worldwide

networks, and online streaming channels is no easy task.

Luckily, VER was onsite in the control room, transmission area, machine room, and content-production areas deploying the best gear, including Ericsson encoders for ASI transmission, Nimbra encoders for J2K transmission, an Evertz EQX router, nine EVS XT3 servers, and the Harmonic Media Grid and Content Grid storage system with 120 TB of nearline storage.

With the world's largest inventory of rental equipment, VER supplies the most advanced technology to a broad array of corporate, TV, cinema, event, and broadcast clients, which rely on VER's depth of experience in audio, video, lighting, LED, cameras, rigging, media servers, fiber, and more.



VISTA Worldlink was awarded the integration and publishing of CONCACAF's Scotia Champions League (SCCL) events to Facebook Live, running from August through October. The VISTA facility offered these continuing services to CONCACAF throughout the summer and fall, complementing many additional Integration services for MLS and USL.

These CONCACAF services combined the expertise of VISTA's 24/7 master control, acquiring the signal from an international satellite and bringing the signal into VISTA via fiber from strategic partners Intelsat and Arqiva. The signal was then integrated by VISTA's Digital Media Center with world-feed graphics and English commentary, via VISTA control rooms and audio booths. The feed was then encoded and published to CONCACAF's Facebook Live accounts.



YES has been providing mobile-production services since 1982. With quality engineering design and great engineering support, YES has built a reputation on service and satisfaction for its clients. Regardless of the size or complexity of the production, YES's technical staff is there to ensure that clients receive the company's complete attention to every detail. 



# T2

# COMPUTING

At T2 Computing we know the solutions and industry standards required to manage a company's critical media assets. We have managed broadcast and film post-production for global media companies and are known for experience, talent, and creativity in the media workflow space. From production to archive, our highly experienced client and professional services teams pinpoint and installs the most efficient and reliable tools to develop end-to-end digital media solutions for broadcast, journalism, marketing, sports, music, film, and post-production clients.

**At T2 Computing, your experience and our experience matters. Contact us and let us explain how our expertise can help you gain greater business value.**

[www.t2computing.com](http://www.t2computing.com)



119 West 23rd Street, Suite 206, New York, NY 10011  
212.220.9600 • [www.t2computing.com](http://www.t2computing.com)



**LTN...**  
it's the  
**power**  
of our  
**network**  
for broadcast & digital

Join the ever-growing  
**LTN Network**

of colleges and universities that connect to the broadcast and digital world by utilizing the power and ubiquity of LTN's fully-managed Global IP Network. No need for costly uplink trucks, earth stations or long-term fiber contracts to transmit your live or pre-recorded sporting or news events anywhere in the world.

Build your college and college sports brand awareness, brand equity and revenue opportunities through broadcasting or streaming of your school's:

- |  |  |  |
|--|--|--|
| <ul style="list-style-type: none"><li>• Home and Away Sporting Events to Local, Regional National and Digital Broadcasters</li><li>• Away Games to School's Television Network</li><li>• Game Footage and Highlights</li></ul> | <ul style="list-style-type: none"><li>• Championship Games, Bowl Games, Tournaments, &amp; Competitions</li><li>• Conference/League and Guest Events</li><li>• Exclusive Player and Coach's Interviews</li></ul> | <ul style="list-style-type: none"><li>• Breaking News</li><li>• Expert Guest Speakers - "Live Shots"</li><li>• Media/News Releases and Satellite Media Tours</li><li>• Convocations and Graduation</li><li>• Concerts &amp; Community Events</li></ul> |
|--|--|--|

Delivering your live video has never been easier. LTN's cost-effective, simple, quick, and convenient solution makes LTN your one-stop college venue broadcast partner! To learn more visit [www.ltnglobal.com](http://www.ltnglobal.com).

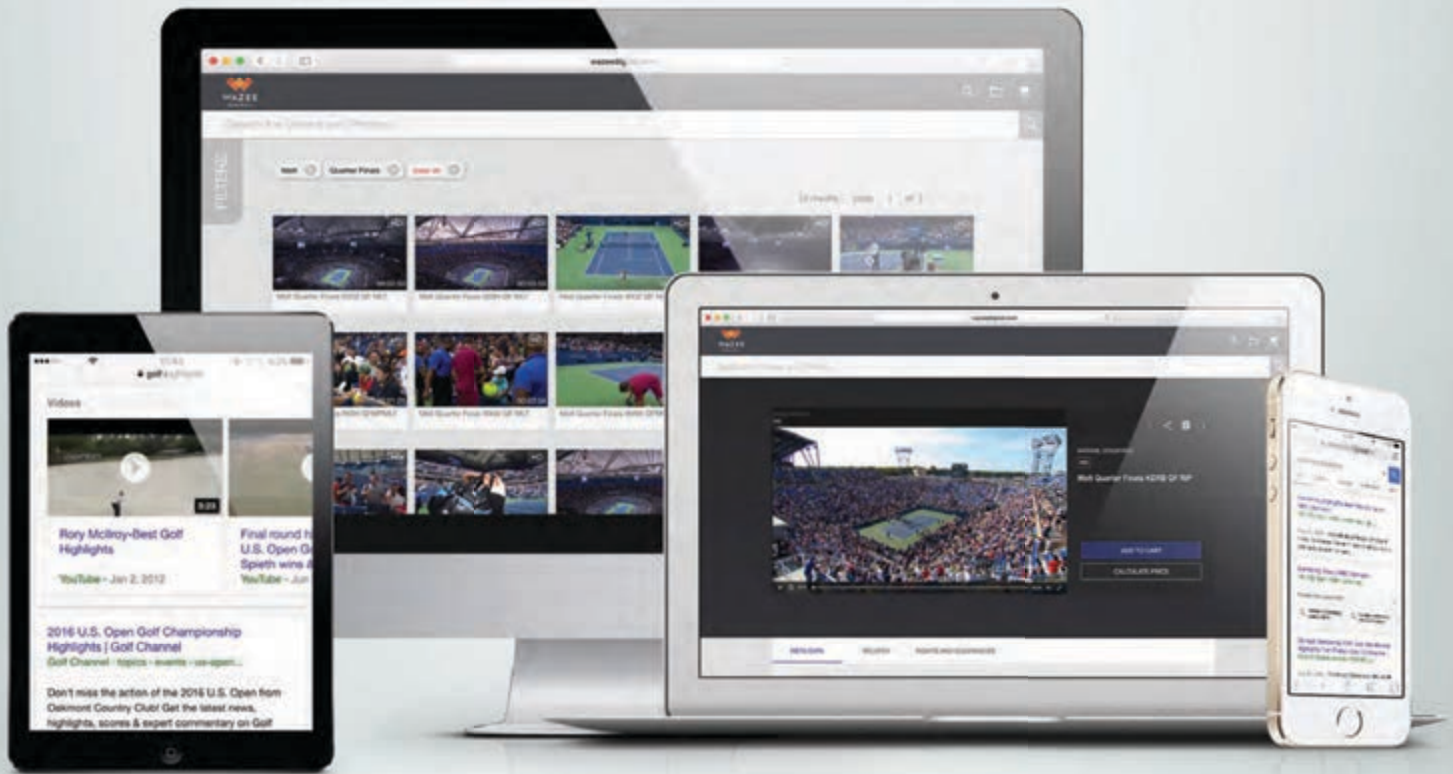

# KEEP YOUR FANS ENGAGED

Wazee Digital Media Hub enhances the engagement of your event by allowing real-time access and distribution of content.

## FOR MORE INFORMATION

[www.wazeedigital.com/digital-media-hub](http://www.wazeedigital.com/digital-media-hub)

**BROCADE**<sup>®</sup>



**Who knew 42,000  
fans could have  
their own personal  
network?**

**Stadium networks run  
better on Brocade.**





# EXCLUSIVE BROADCASTING

Technology that CUTS the Edge - then

..... **PUSHES IT**

## Changing The Way You View The World



BSI Real Freedom Transmitter

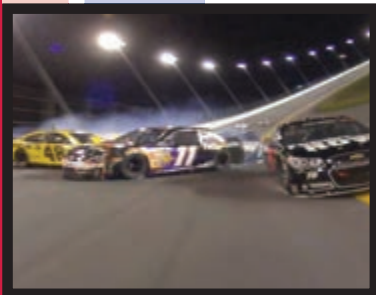

Onboard Bumper Cam



RF and Onboard Cameras



1.4GHz Wireless Mics

At BSI, we design, develop and deploy wireless technologies that take live broadcast productions from  
**ORDINARY TO EXTRAORDINARY!**

We tailor audio, video and communications packages to meet the unique needs of every customer and back our **UNBEATABLE TECHNOLOGY** with **FIRST-CLASS, ON-SITE CUSTOMER SUPPORT.**

**Let us help bring your vision into focus.**

[www.BSIintl.com](http://www.BSIintl.com)



**Reseller Specializing in Video Storage Solutions**

# **Media • Entertainment • Sports**

**PROVIDING**

- Next Generation storage platforms
- Content production
- Distribution
- Archive
- Performance and reliability
- Focused on extreme production and delivery deadlines.
- Proven File Systems
- Optimized for Video
- End-to-end solution from ingest to archive.
- Designed for performance from the ground up
- Built on the foundation of high-performance collaboration
- Clients include leading post and broadcast organizations
- Proven history of providing solutions to clients in both the NBA<sup>®</sup>, NCAA<sup>®</sup> and more

**Data Storage Solutions  
Purpose Built to  
Handle the Demanding  
Performance of HD, 4K,  
8K and Beyond**

**Scalable Solutions to  
handle all Workflows  
from Ingest to Edit to  
Streaming to Archive**

**LH COMPUTER SERVICES**

Doug Cole • DCOLE@LHCOMP.COM • www.LHcomp.com • 954.648.0171

# VENDOR SERVICES



Courtesy of



# Directory

The *SVG Mobile Sports Production Yearbook* has again partnered with ProductionHUB to offer a comprehensive directory for those in search of crewing services, generators, satellite trucks, and remote-production units.

ProductionHUB.com, a respected online resource, lists not only the vendors covered here but also a wealth of other production-services companies as well. The site also boasts one of the

top job boards in the industry, a valuable tool for freelancers seeking work and for today's growing number of sports networks and content creators.

Feel free to use the state-by-state U.S. services directory here as a starting point for finding the providers that best meet your needs, but also be sure to visit ProductionHUB.com for the most up-to-date information on potential suppliers and service providers. 

# VIRTUAL REALITY PRODUCTION UNIT

---

Our VR production unit have worked on venue for the most important European football events over the last six months, and we are now ready to deliver a unique, new user experience to fans worldwide.

As a part of our **Digital Host Services** for sport federations and leagues, Virtual Reality will provide valuable additional content to any sport media offering - bring on the "Beyond TV" revolution.

---

info@deltatre.com  
www.deltatre.com  
follow us  





# ILLUMINATING YOUR PATH TO VICTORY



LIGHTING | AUDIO | LED VIDEO | LOGISTICS +

@PRGLIVE   

For more information on our services, visit [prg.com](http://prg.com)



# What Could You Do With The Power Of Real Time Video Analytics?

## Enhance your broadcast story

Fans love their stats, and you want to give them robust, insightful, exciting, and revolutionary coverage. What if you could give them the G-force of that tackle, how fast an athlete accelerates, the speed and trajectory of that kicked ball, or the splash circumference of the dive...all in real time?

Isolate any player and capture the variable statistics important for your game storyline. Forget ancient tracking methods. No need for those costly RFID infrastructures. Get them from cameras already capturing the action. Don't wait hours for statistics when OSI can make you the superstar with real time superstats.

## Image Recognition & Brand Monitoring

For marketing, branding, intelligence monitoring, or product recognition, OSI provides the capability to search brands, faces, and logos within video and social media. OSI's logo and brand detection ability can be used to profile logos/faces on a passing truck in the news, capture athletics apparel in a broadcast, or tell you how many times your executives have appeared on television and social media outlets. Be on top of real-time brand recognition the moment it airs, and have control of its message.

## Broaden your advertising

Advertising space is limited and always at a premium. Why aren't you using that dead space next to the batter? Why not have the ability to dynamically ingest an advertisement into the end zone background of a Hail Mary? There's no longer a need to introduce additional fixed cameras. OSI can create a virtualized advertisement practically anywhere. Digitally imprinting on any surface is easy with OSI's visual analytics.

Visit [www.orgstrategies.com/industries/media-entertainment/](http://www.orgstrategies.com/industries/media-entertainment/) or email [sports-solutions@orgstrategies.com](mailto:sports-solutions@orgstrategies.com) for more information.



# FIND

ENGs, LIVE STREAMING  
& SPORTS VIDEO  
VENDORS



# GET FOUND

877.629.4122 | [ProductionHUB.com](http://ProductionHUB.com)

# Crew Services

STATE	CITY	COMPANY NAME	WEBSITE	PHONE
ALABAMA	Birmingham	Beverly Boy Productions	www.beverlyboy.com	(888) 462-7808
	Birmingham	Crewsouth	www.crewsouth.com	(205) 862-4271
ARIZONA	Phoenix	Assignment Desk	www.assignmentdesk.com	(800) 959-3375
	Phoenix	Burke Brothers Productions	www.BBPTV.com	(602) 321-0398
	Phoenix	High End Labor Pool	www.highendlaborpool.com	(602) 225-2454
	Phoenix	Reel Men	www.reelmen.com	(602) 286-6800
	Phoenix	Crew West	www.crewwestinc.com	(888) 444-2739
	Tucson	Monsoon Production Services	www.monsoonps.com	(520) 623-3144
CALIFORNIA	Alta Loma	LocalCrew.tv	www.localcrew.tv	(909) 980-4033
	Burbank	Imagecraft Productions	www.imagecraftproductions.com	(818) 954-0187
	Los Angeles	Assignment Desk	www.assignmentdesk.com	(800) 959-3375
	Los Angeles	Run & Gun Production Services	www.rgps.tv	(310) 463-4394
	San Diego	Crystal Pyramid Productions	www.crystalpyramid.com	(619) 644-3000
	San Francisco	Assignment Desk	www.assignmentdesk.com	(800) 959-3375
	Van Nuys	Wintech Video	www.wintechvideo.com	(818) 501-6565
COLORADO	Denver	Assignment Desk	www.assignmentdesk.com	(800) 959-3375
	Golden	Crew Connection	www.crewconnection.com	(800)352-7397
CONNECTICUT	Hartford	FastLights	www.FastLights.com	(855) 922-5600
DISTRICT OF COLUMBIA	Washington	Assignment Desk	www.assignmentdesk.com	(800) 959-3375
	Washington	Beverly Boy Productions	www.beverlyboy.com	(888) 462-7808
	Washington	Broadcast Management Group	www.broadcastmgmt.com	(202) 609-7757
	Washington	I.A.T.S.E. Local 22	www.iatselocal22.com	(202) 269-0212
	Washington	The Camera 1 Group	www.thecamera1group.com	(301) 252-1010
FLORIDA	Hollywood	Jolly Roger Images	www.jollyrogerimages.com	(954) 658-3332
	Lake Mary	Skystorm Productions	www.skystorm.com	(407) 328-4747
	Melbourne	David Waters Productions	www.facebook.com/davidwatersproductions/	(321) 525-1290
	Miami	5K Productions	www.5kproductions.com	(786) 519-1880
	Miami	Assignment Desk	www.assignmentdesk.com	(800) 959-3375
	Miami	Stonehenge Circle	www.stonehengecircle.com	(786) 344-3142
	Orlando	Beverly Boy Productions	www.beverlyboy.com	(888) 462-7808
	Sunrise	Full Moon Creative	www.fullmooncreative.com	(954) 742-2622
	Wellington	Afflux Studios	www.affluxstudios.com	(561) 601-0718
GEORGIA	Atlanta	Assignment Desk	www.assignmentdesk.com	(800) 959-3375
	Atlanta	Beverly Boy Productions	www.beverlyboy.com	(888) 462-7808
	Atlanta	Lighting & Production Equipment	www.lpe.com	(800) 275-3721
	Atlanta	Swirl Films / Rentals	www.swirlfilms.com	(910) 798-2934
	HAWAII	Honolulu	Hawaii Camera Rental	www.hawaicamera.com
IDAHO	Nampa	Chris Wade Media	www.chriswademedias.com	(208) 850-0400
ILLINOIS	Carol Stream	Visions of Light Chicago	www.visionsoflight.com	(312) 829-8244
	Chicago	Assignment Desk	www.assignmentdesk.com	(800) 959-3375
	Chicago	Beverly Boy Productions	www.beverlyboy.com	(888) 462-7808
	Chicago	Complete Crewing	www.completecrewing.com	(773) 645-2000
	Chicago	Fulton Market Films	www.fultonmarketfilms.com	(312) 243-1414
	Chicago	Clarion	www.clarioncrews.com	(847) 543-1188
	Chicago	Assignment Desk	www.assignmentdesk.com	(800) 959-3375
	INDIANA	Indianapolis	Beverly Boy Productions	www.beverlyboy.com
IOWA	Hiawatha	Metro Studios	www.metro-studios.com	(319) 363-2002
KENTUCKY	Louisville	Beverly Boy Productions	www.beverlyboy.com	(888) 462-7808
LOUISIANA	New Orleans	Assignment Desk	www.assignmentdesk.com	(800) 959-3375
	New Orleans	Beverly Boy Productions	www.beverlyboy.com	(888) 462-7808
	New Orleans	Holub Film	www.holubfilm.com	(504) 338-4567



# beck<sup>TV</sup>

Value.  
Experience.  
Commitment.

BeckTV has designed and built more professional television facilities for more customers than any other systems integrator. We bring the experience and expertise you need to create and deliver your content to your audience in the formats that you require.

Austin · Denver · New York · [becktv.com](http://becktv.com)



## **FUTURE-PROOF YOUR MEDIA WORKFLOWS. TODAY.**

Because every moment counts, the world's leading sports and entertainment organizations rely on DDN Storage to deliver game-changing performance and scalability that cost-effectively produce and monetize content—now and for years to come.

Only DDN can deliver full bandwidth on multiple streams of the most demanding formats like 4K, 8K, UHD, HDR, and IMF, as well as cloud-based workflows, while delivering significant performance, density, and efficiency advantages.



VISIT [DDN.COM/MEDIA](https://www.ddn.com/media) TO LEARN MORE

©2016 DataDirect Networks. All Rights Reserved.



Haivision's video streaming and media management solutions engage fans at the largest stadiums and arenas, and power the world's leading sports broadcasters.

## REAL-TIME GAME ANALYSIS

Low latency HD video connects referees with remote officials in real-time, so they can make the right call.

## INTERACTIVE BROADCAST INTERVIEWS

Connect remote studios with low latency, HD, bi-directional video, for live interviews & commentary over public Internet.

## STADIUM MEDIA

Deliver low latency, high-quality media experiences from the field to video display systems in private suites, retail areas and concourses.

# Crew Services

STATE	CITY	COMPANY NAME	WEBSITE	PHONE
MASSACHUSETTS	Boston	Assignment Desk	www.assignmentdesk.com	(800) 959-3375
	Boston	Beverly Boy Productions	www.beverlyboy.com	(888) 462-7808
	Boston	FastLights	www.FastLights.com	(855) 922-5600
	Boston	Heavy Digital	www.heavydigital.net	(617) 419-0043
	Boston	PixMix Video Services	www.pixmix.net	(617) 254-0590
	Hudson	StoneMedia Productions	www.stonemediapro.com	(978) 568-1200
	Milton	Boston Video Crews	www.bostonvideocreus.com	(617) 834-3412
	Newton	Green Line Group	www.glgvtv.com	(617) 229-6202
	MICHIGAN	Detroit	Beverly Boy Productions	www.beverlyboy.com
MINNESOTA	Minneapolis	Beverly Boy Productions	www.beverlyboy.com	(888) 462-7808
MISSOURI	Kansas City	Beverly Boy Productions	www.beverlyboy.com/videographers-usa/	(888) 462-7808
	St. Louis	Beverly Boy Productions	www.beverlyboy.com	(888) 462-7808
NEVADA	Las Vegas	Avenger Productions	www.avengerproductions.com	(702) 655-3339
	Las Vegas	Carafelli Productions	www.carafelliproductions.com	(702) 525-1129
	Las Vegas	FiveSix Productions	www.fivesix.com	(702) 749-5456
	Las Vegas	JCS Broadcast Video Productions	www.jcsvideo.com	(800) 791-8671
NEW JERSEY	Jersey City	Beverly Boy Productions	www.beverlyboy.com	(888) 462-7808
	Newark	Art Contra Studio	www.artcontrastudio.com	(908) 377-9083
NEW YORK	Albany	FastLights	www.fastlights.com	(855) 922-5600
	Buffalo	Odessa Pictures	www.odessapictures.com	(716) 316-6710
	Kings Park	Jammin Design Productions	www.jammindesignproductions.com	(631) 292-9632
	Manhattan	Studio 253 NYC @ E.C. Pro Video	www.studio253nyc.com	(212) 333-5570
	Manhattan	The People's DP	www.thepeoplesdp.com	(646) 415-7782
	New York	Assignment Desk	www.assignmentdesk.com/	(800) 959-3375
	New York	Atlantic Television	www.atlantictv.com	(212) 625-9327
	New York	Beverly Boy Productions	www.beverlyboy.com	(888) 462-7808
	New York	Filmwerk Media	www.filmwerk.tv	(212) 645-6668
	New York	GhostPepper	www.ghostpepper.tv	(212) 675-8287
	New York	Jeff Turick   422 Films	www.newyorkdirectorofphotography.com	(917) 817-8721
	New York	Man With A Cam	www.manwithacam.org	(646) 688-3447
	New York	NBTV Studios	www.NBTVstudios.com	(646) 277-4900
	New York	Technical Operations	www.tech-ops.com	(212) 465-1318
NORTH CAROLINA	Charlotte	Assignment Desk	www.assignmentdesk.com	(800) 959-3375
	Matthews	Production Management Specialist	www.productionmanagementspecialists.com	(803) 228-0271
	Raleigh	Beverly Boy Productions	www.beverlyboy.com	(888) 462-7808
	Raleigh	On Location North Carolina Film & Video Equipment Services	www.onlocation-nc.com	(919) 755-9488
OHIO	Mansfield	Beverly Boy Productions	www.beverlyboy.com	(888) 462-7808
OKLAHOMA	Oklahoma City	Oklahoma Film Commission	www.ok.gov/oklahomafilm	(405) 230-8440
OREGON	Portland	Doug Birnbaum Photography	www.DougBirnbaum.com	(949) 205-9980
	Portland	Picture This Production Services	www.pixthis.com	(503) 235-3456
	Portland	Portland Film Company	www.facebook.com/PortlandFilmCompany	(503) 897-8002
	Portland	ROSTER	www.rosterreps.com	(503) 381-2067
PENNSYLVANIA	Clifton Heights	TheCrewStore	www.thecrewstore.com	(484) 688-0142
	Conshohocken	Wonderful Machine	www.wonderfulmachine.com	(610) 260-0200
	Media	Allied Pixel Services	www.alliedpixel.com	(610) 892-7970
	Philadelphia	Assignment Desk	www.assignmentdesk.com	(800) 959-3375
	Philadelphia	Total Production Services	www.tpsweb.com	(888) 877-1178
	Pittsburgh	Beverly Boy Productions	www.beverlyboy.com	(888) 462-7808
	Pittsburgh	Cortron Media	www.cortronmedia.com	(412) 565-3471





Any coach will tell you that winning in a competitive sporting environment requires  
**Preparation, Experience, & Teamwork**

Specializing in Sports and Live Events, the Diversified team has the dedication and expertise to bring your project from playbook to **end zone!**

844.767.2738  [diversifiedus.com](https://www.diversifiedus.com)





# CAPTURE THE ACTION

## Sanken Production Microphones

### Shotgun Mics

Wide range of shotgun mics for every application. Rejection, reach, stereo, 5.0, the options are as wide as the frequency response and **truly** unique.



### Lav Mics

Continuing to be the superior choice, small in size and big in sound. The industry leading technology in an attractive set of colors and accessories.



### Head Worn Mics

Lightweight, ultra-miniature and easy to hide, but providing exceptional sound quality and low profile for live performance and video production.



plus24 distributes Sanken Lavalier, Shotgun, Studio, and Headworn Microphones in North America through authorized dealers and distributors

[plus24.net](http://plus24.net)

# LIVE MOBILE BROADCASTING

Provide your customers and users the ability to **live-stream video** from **anywhere** to **anywhere**, at **any time**.



INTRODUCING...

## Wowza GoCoder SDK

Wowza now provides a complete technology toolkit for a seamless, integrated end-to-end mobile broadcasting solution. Powered by standalone or hybrid workflows built on Wowza Streaming Engine and Wowza Streaming Cloud.



-  High-quality viewer experiences
-  Increased speed to market
-  Lower development costs
-  Unlimited scalability



Get Started Today!

For more information or to start your free trial, visit [www.wowza.com/products/gocoder/sdk](http://www.wowza.com/products/gocoder/sdk) or contact [sales@wowza.com](mailto:sales@wowza.com).



## Crew Services

STATE	CITY	COMPANY NAME	WEBSITE	PHONE
RHODE ISLAND	Providence	FastLights - Providence, Rhode Island	www.fastlights.com	(855) 922-5600
TENNESSEE	Chattanooga	6 STRONG MEDIA	www.sixstrongmedia.com	(423) 414-2313
	Nashville	Assignment Desk	www.assignmentdesk.com	(800) 959-3375
	Nashville	Beverly Boy Productions	www.beverlyboy.com	(888) 462-7808
TEXAS	Austin	Beverly Boy Productions	www.beverlyboy.com	(888) 462-7808
	Austin	Earl Miller Productions	www.earlmillerproductions.com	(512) 458-4343
	Dallas	Assignment Desk	www.assignmentdesk.com	(800) 959-3375
	Dallas	TCG Films - Taylor Garvin	www.tcgfilms.com	(214) 455-2765
	Houston	Assignment Desk	www.assignmentdesk.com	(800) 959-3375
	Houston	Beverly Boy Productions	www.beverlyboy.com	(888) 462-7808
UTAH	Salt Lake City	Fiftyfilms	www.fiftyfilms.com	(801) 875-8049
VIRGINIA	Arlington	Global Voice Hall	www.globalvoicehall.com	(703) 566-4008
	Richmond	Beverly Boy Productions	www.beverlyboy.com	(888) 462-7808
WASHINGTON	Seattle	Assignment Desk	www.assignmentdesk.com	(800) 959-3375
	Seattle	LDM Worldwide Productions	www.ldmworldwide.com	(206) 463-1902
WISCONSIN	Madison	Grassland Media	www.grasslandmedia.com	(608) 238-7575

## Generators

STATE	CITY	COMPANY NAME	WEBSITE	PHONE
ALASKA	Anchorage	Northern Lights Marine Generators	www.northern-lights.com	(907) 561-7941
	Fairbanks	SolarAlaska	www.solaralaska.com	(907) 235-6842
ARIZONA	Mesa	Sound Lighting F/X	www.soundlightingfx.com	(602) 722-0783
	Phoenix	Reel Men	www.reelmen.com	(602) 286-6800
	Phoenix	United Rentals	www.ur.com	(623) 850-5100
	Tucson	H & E Equipment Services	www.he-equipment.com	(520) 770-1120
	Tucson	Monsoon Production Services	www.monsoonps.com	(520) 623-3144
ARKANSAS	Little Rock	Continuous Grip Electric Services	www.gripelectric.com	(501) 772-0445
	Mena	Laark Honeywagons	www.laarkhoneywagons.com	(818) 516-6474
	North Little Rock	North Little Rock Electric Department	www.nrelectric.com	(501) 975-8888
CALIFORNIA	Burbank	AC Power Distribution	www.acpowerdistribution.com	(818) 848-4004
	Burbank	Light Hollywood	www.lighthollywood.com	(408) 406-1832
	Burbank	Skye Rentals	www.skyerentals.com	(323) 462-5934
	Burbank	United Rentals - Burbank	www.ur.com	(818) 842-5288
	Calabasas	Studio Air Conditioning Rentals	www.studioairconditioning.com	(818) 222-4143
	Carson	Multiquip	www.multiquip.com	(800) 421-1244
	Chatsworth	Cinerep International	www.cinerepamps.com	(818) 882-2677
	Compton	CAT Entertainment Services	www.es-cat.com	(866) 762-5228
	Granada Hills	LIGHT IT UP - Grip Lighting Electric Truck Rentals	www.LightitupLA.com	(818) 679-4321
	Los Angeles	All-in-One-Truck	www.all-in-one-truck.com	(888) 818-7825
	Los Angeles	CFG - Grip Truck and Lighting Rental	www.CFGRentals.com	(323) 977-8520
	Los Angeles	La Brea Air	www.labrearentals.com	(800) 452-2732
	Los Angeles	W.A. Benjamin Electric	www.benjaminlectric.com	(213) 749-7731
	Norco	Norco Equipment Rentals	www.norcoequipmentrental.com	(951) 371-1231
	North Hollywood	Star Power Generators	www.starpowergenerators.com	(818) 982-2200
Oxnard	At Power	www.atpower.biz	(818) 424-1396	
Paramount	Location Air	www.locationair.tv	(855) 444-4757	
Placentia	Temp Power Systems	www.temppower.com	(800) 748-6997	
Richmond	Top Productions	www.top-productions.com	(415) 332-3005	



## Experience more

We work with leading sports organisations globally to transform content into the ultimate viewer experience

[www.mx1.com](http://www.mx1.com)



# New technologies can be confusing

**CTG has the knowledge and  
expertise to help you through**

When it's time to upgrade CTG  
is the company that can lead  
you through the maze of options.  
With everything under one roof  
we have the knowledge and  
expertise to guide you.

*Contact CTG today and let us  
help you get through the maze.*



**CTG**  
*Comprehensive Technical Group*  
*Go Further Start Here*



# CHANGING THE GAME

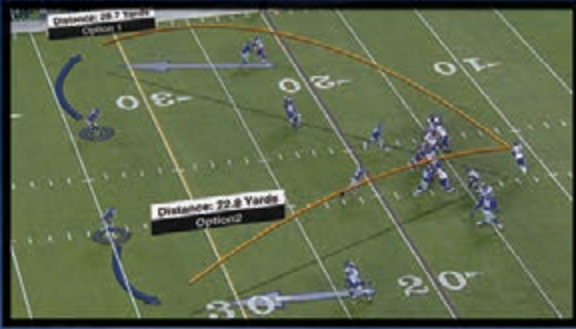

## SPORTS GRAPHICS

With a range of broadcast graphic solutions using the latest 3D rendering techniques, we have been enhancing sports productions for a while now by providing an on air look that is second to none in quality and rendering power.

VR/AR, text overlays, sports analysis, panoramic stitch all with rich data integration and web based control solutions are all part of our game. Visit [rtsw.co.uk](http://rtsw.co.uk) to find out why more and more international broadcasters are making it part of theirs.



YOUR INTERNET SHOULD BE  
RELIABLE, DEDICATED, REDUNDANT, SYMMETRICAL,  
WONDERFUL!



Discover a wonderful Internet experience with Rainbow Broadband.

Visit [rainbowbroadband.com](http://rainbowbroadband.com) or call **1-800-747-1830** to get connected.







# Taking content further

Through our global reach and local presence on each continent, we secure contribution, international distribution and broadcast remote production for every type of sporting events

[globecast.com](http://globecast.com)

part of the Orange group

# Generators

STATE	CITY	COMPANY NAME	WEBSITE	PHONE
	San Diego	Andrus Lighting and Grip	<a href="http://www.andruslighting.com/Andrus_Grip/crew.html">www.andruslighting.com/Andrus_Grip/crew.html</a>	(619) 521-0585
	San Fernando	Illumination Dynamics	<a href="http://www.illuminationdynamics.com">www.illuminationdynamics.com</a>	(818) 686-6400
	San Francisco	Cresco Production Express	<a href="http://www.crescorent.com">www.crescorent.com</a>	(415) 920-2801
	Santa Clarita	Santa Clarita Movie Ranch	<a href="http://www.filmsantaclarita.com/for-filmmakers/movie-ranch-overlay-zone/">www.filmsantaclarita.com/for-filmmakers/movie-ranch-overlay-zone/</a>	(661) 284-1425
	Sun Valley	DADCO	<a href="http://www.dadcopowerandlights.com">www.dadcopowerandlights.com</a>	(818) 768-8886
	Sylmar	Hollywood Rentals	<a href="http://www.hollywoodrentals.com">www.hollywoodrentals.com</a>	(800) 233-7830
COLORADO	Littleton	Lighting Services	<a href="http://www.lsidenver.com">www.lsidenver.com</a>	(303) 722-4747
CONNECTICUT	Hartford	FastLights	<a href="http://www.FastLights.com">www.FastLights.com</a>	(855) 922-5600
	Shelton	Lex Products	<a href="http://www.lexproducts.com">www.lexproducts.com</a>	(203) 363-3738
FLORIDA	Clearwater	Command	<a href="http://www.cmnd.com">www.cmnd.com</a>	(727) 560-0134
	Dania	EmPower Generators	<a href="http://www.empowergenerators.net">www.empowergenerators.net</a>	(954) 922-3800
	Deerfield Beach	IIS Group	<a href="http://www.iisgroupllc.com">www.iisgroupllc.com</a>	(954) 360-0601
	Fort Lauderdale	Garrett Sound & Lighting	<a href="http://www.garrettsound.com">www.garrettsound.com</a>	(954) 777-3277
	Fort Lauderdale	Production Power & Air	<a href="http://www.productionpowerandair.com">www.productionpowerandair.com</a>	(954) 739-2468
	Fort Lauderdale	Production Toolbox Services	<a href="http://www.productiontoolbox.com">www.productiontoolbox.com</a>	(954) 463-4820
	Hollywood	Rental Stages	<a href="http://www.RentalStages.com">www.RentalStages.com</a>	(954) 989-8898
	Hollywood	Sidram Power	<a href="http://www.sidrapower.com">www.sidrapower.com</a>	(954) 989-8898
	Jacksonville	High Contrast Lighting & Grip	<a href="http://www.highcontrastlighting.com">www.highcontrastlighting.com</a>	(904) 910-7355
	Jupiter	Coastal Grip & Electric	<a href="http://www.coastalgrip.com">www.coastalgrip.com</a>	(561) 281-4973
	Miami	Americas Generators	<a href="http://www.gopower.com">www.gopower.com</a>	(800) 434-0003
	Miami	Megawattage	<a href="http://www.megawattage.com">www.megawattage.com</a>	(954) 302-3565
	Opa Locka	MAGIC II Lighting and Grip	<a href="http://www.magic2lighting.com">www.magic2lighting.com</a>	(305) 685-1811
	Orlando	CAT Entertainment Services	<a href="http://www.es-cat.com">www.es-cat.com</a>	(877) 228-2852
	Orlando	DataPro Systems	<a href="http://www.dataprosystems.com">www.dataprosystems.com</a>	(407) 292-4282
	Orlando	Hollywood Rentals	<a href="http://www.hollywoodrentals.com">www.hollywoodrentals.com</a>	(407) 852-0164
	Orlando	Walker Miller Equipment	<a href="http://www.walkermiller.com">www.walkermiller.com</a>	(407) 299-2620
	Pinellas Park	First Unit Production Services	<a href="http://www.firstunit.com">www.firstunit.com</a>	(727) 522-2203
	St. Augustine	CAT Entertainment Services	<a href="http://www.es-cat.com">www.es-cat.com</a>	(877) 228-2852
GEORGIA	Atlanta	BigCity Leasing & Production Equipment	<a href="http://www.bigcityleasing.com">www.bigcityleasing.com</a>	(678) 922-2490
	Atlanta	Hertz Energy Services	<a href="http://www.hertzequip.com">www.hertzequip.com</a>	(404) 351-5920
	Atlanta	Wavelength Generators	<a href="http://www.day1atl.com">www.day1atl.com</a>	(404) 687-9511
	Savannah	Ross SysCon	<a href="http://www.rosssyscon.com">www.rosssyscon.com</a>	(912) 238-5800
	Tucker	Hollywood Rentals	<a href="http://www.hollywoodrentals.com">www.hollywoodrentals.com</a>	(770) 939-0475
ILLINOIS	Carol Stream	Visions of Light	<a href="http://www.visionsoflight.com">www.visionsoflight.com</a>	(312) 829-8244
INDIANA	Indianapolis	Hammer Lighting & Grip	<a href="http://www.hammergrip.tv">www.hammergrip.tv</a>	(317) 547-4747
IOWA	Alta	Gull Wing Industries	<a href="http://www.gull-wing.com">www.gull-wing.com</a>	(800) 838-1482
	Des Moines	Pratt Audio-Visual & Video	<a href="http://www.prattav.com">www.prattav.com</a>	(515) 280-9800
	Oskaloosa	Musco Lighting	<a href="http://www.musco.com">www.musco.com</a>	(800) 825-6030
KANSAS	Kansas City	Lights On Kansas City	<a href="http://www.lightson.com/rental/kansascity">www.lightson.com/rental/kansascity</a>	(913) 362-6940
	Overland Park	Prime Light	<a href="http://www.paddock.com/primelight">www.paddock.com/primelight</a>	(913) 226-0849
	Wichita	Foley Equipment	<a href="http://www.foleyeq.com">www.foleyeq.com</a>	(316) 943-4211
KENTUCKY	Louisville	Red Star Pictures	<a href="http://www.redstarpictures.com">www.redstarpictures.com</a>	(855) 522-5272
LOUISIANA	Baton Rouge	Digital FX	<a href="http://www.digitalfx.tv">www.digitalfx.tv</a>	(888) 898-6010
	Baton Rouge	Hollywood Trucks	<a href="http://www.hollywoodtrucksllc.com">www.hollywoodtrucksllc.com</a>	(225) 330-6126
	Kenner	Aggreko - Louisiana	<a href="http://www.aggreko.com">www.aggreko.com</a>	(504) 461-0556
	New Orleans	Available Lighting	<a href="http://www.availablelighting.com">www.availablelighting.com</a>	(504) 831-5214
	New Orleans	Center Staging	<a href="http://www.centerstaging.net">www.centerstaging.net</a>	(504) 247-0020
	New Orleans	Hollywood Rentals - New Orleans	<a href="http://www.hollywoodrentals.com">www.hollywoodrentals.com</a>	(504) 729-5090
	New Orleans	Nola Film Logistics	<a href="http://www.nolafl.com">www.nolafl.com</a>	(504) 309-6612
	New Orleans	Silver Screen Supply	<a href="http://www.silverscreensupplies.com">www.silverscreensupplies.com</a>	(504) 737-0555
MARYLAND	Baltimore	Plus One Rentals	<a href="http://www.plusonerentals.com">www.plusonerentals.com</a>	(410) 279-5344
MASSACHUSETTS	Amesbury	Munters Corp. - MCS Headquarters	<a href="http://www.munters.com">www.munters.com</a>	(978) 241-1100
	Avon	Equipment 4 Rent	<a href="http://www.equipment4rent.net">www.equipment4rent.net</a>	(508) 583-5500
	Boston	FastLights	<a href="http://www.FastLights.com">www.FastLights.com</a>	(855) 922-5600

# TRANSPORTING SPORTS OVER IP.

**IT'S WHAT WE DO,  
AND IT'S WHAT WE DO WELL!**

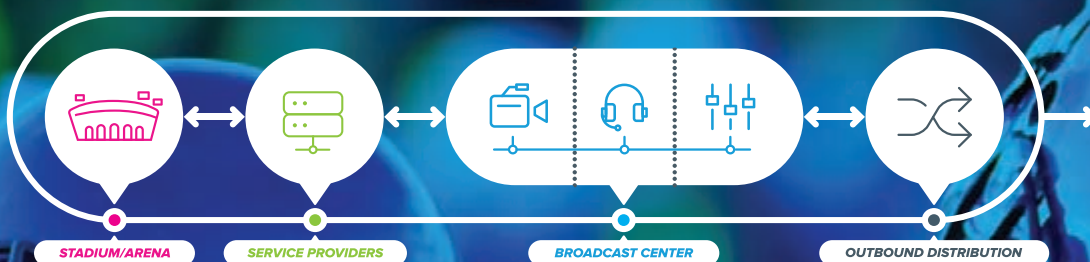

When downtime isn't an option, choose Media Links media over IP transport and switching solutions. Whether you need to deliver your sports content down the hall, or across the globe, Media Links offers robust and proven transport solutions for the most demanding live sports environments

Media Links' IP-based technology has been the backbone of soccer World Cups, Winter and Summer Games, major US American Football events, Asian Games, and many other high profile global sporting events since 2002.

Proven workflow,  
benefits and ROI

## SPORTS WITHOUT LIMITS

**NOW EVERYTHING IS LOCAL**

Call 860-206-9163

[www.medialinks.com](http://www.medialinks.com)

**MEDIA LINKS®**  
Media Defined Networking®

**MEDIA LINKS®**  
Media Defined Networking

VIDEO, AUDIO  
AND DATA  
IP BROADCAST  
WORKFLOW

VISUALLY  
LOSSLESS  
COMPRESSION

CONNECT  
YOUR WAY  
BUILT ON OPEN  
STANDARDS

PROTECTED  
TRANSFER  
TRUE HITLESS  
SWITCHING

UNLIMITED  
NETWORK SIZE  
ZERO PACKET  
LOSS

CAPTURE &  
CONTROL  
ULTRA LOW  
LATENCY

CAPTURE &  
CONTROL  
ULTRA LOW  
LATENCY

# Xcellis Workflow Storage



High Performance, Massively Scalable Primary Storage Coupled with IMT's Industry-leading Experts in Storage Technologies



Quantum Xcellis: Introducing a powerful and scalable system that simplifies storage architecture and streamlines operations. Xcellis enhances workflows, boosts efficiency, improves productivity, and enables business insight.

## KEY FEATURES & BENEFITS

- Efficient, converged architecture
- Flexible, continuous scalability
- Unified Access
- High-Performance
- Powered by Quantum StorNext

## INTEGRATED MEDIA TECHNOLOGIES, INC. (IMT)

Integrated Media Technologies, Inc. (IMT) is a consulting, design, and systems integration company that specializes in providing business consulting and TCO models for private, hybrid, and public cloud workflow solutions. Customers rely on IMT to deliver mission critical solutions and services focused on media technologies, storage, asset management, high-performance computing, networking, and 24/7 support.

Integrated Media Technologies Inc. (IMT) is a Digital Media and Technology Company with offices in Los Angeles, Silicon Valley and Dallas. IMT serves the Media & Entertainment, Information Technology, Government/ Education, and Healthcare sectors with a broad range of solutions designed to drive new value and efficiencies from technology. IMT's operations are segmented into three principal businesses: Consulting and Systems Integration Business, Interactive Video, and Localized Media Networks.

For further information on Quantum Xcellis and IMT, visit:

[http://imglobalinc.com/quantum/?svpage=products\\_workflow-storage\\_xcellis](http://imglobalinc.com/quantum/?svpage=products_workflow-storage_xcellis)

# Never miss a single detail



## Help Deliver the Most Stunning Images

Complete, comprehensive 4K HDR workflow solutions from the camera to your viewers across an ever increasing array of devices



### WFM8300 High Performance 4K HDR Waveform Monitor

- Full support for Rec 709 & Rec 2020 (WCG) color gamut
- New HDR capabilities for content acquisition & post production
- Field installable HDR upgrade for only \$1,200!

[www.tek.com/wfm8300](http://www.tek.com/wfm8300)



### Sentry Video Network Monitoring Solution

- Perceptual video quality (eMOS) for H.265 content
- In-depth compliance monitoring
- Real-time, 24/7 QoS & QoE monitoring, analysis, and reporting

[www.tek.com/sentry](http://www.tek.com/sentry)



### MPEG Analyzers

- Detect, isolate, and diagnose root causes of 4K & HEVC content issues
- Unparalleled insight into video test workflow
- Enable a seamless transition to HEVC & 4K

[www.tek.com/MPEG-test-video](http://www.tek.com/MPEG-test-video)

For more information, visit our comprehensive 4K HDR resource page: [www.tek.com/4K](http://www.tek.com/4K)

**Tektronix**

# AIR SHOW

## CUE THE REPLAY

We know you don't get a second chance to capture a game highlight. That's why for over 40 years, we've designed and integrated video and audio systems that meet the unique challenges of our sports clients. No matter what the application, our mission critical solutions stand ready, for anything.



### Recent projects include:

- US Bank Stadium 4K/HD Control Room
- SunTrust Park HD Control Room
- T-Mobile Arena HD Control Room
- Churchill Downs HD Production Facility
- Target Center HD Control Room

### Solutions we offer:

- HD Production Control Rooms
- ESPN 3 Production Systems
- HD Production Studios
- Shared Storage Solutions
- Asset Management & Archiving
- IPTV & Digital Signage
- Broadcast Infrastructure
- Team Facility A/V Solutions



# TVU MLink



---

TVU MLink increases the dependability of live HD video transmission from your satellite or microwave truck by adding cellular uplink.

- Aggregates multiple 3G/4G/LTE cellular modems, satellite, microwave and WiFi transmission mediums
- Features compact, weather-resistant roof mounted antennas to ensure the best possible signal strength for vehicles
- Add or remove any data connection without disrupting a live transmission
- Features TVU's proprietary Inverse StatMux transmission algorithm for dependable live HD video with sub-second latency
- Rack mount design fits easily in satellite and microwave trucks and vans



Learn more at [www.tvunetworks.com](http://www.tvunetworks.com)

# Generators

STATE	CITY	COMPANY NAME	WEBSITE	PHONE
	Devens	New England Studios	<a href="http://content.nestudios.com/film-nestudios">http://content.nestudios.com/film-nestudios</a>	(978) 615-5500
	Woburn	At Kaye Lites	<a href="http://www.kayelites.com">www.kayelites.com</a>	(781) 932-0005
MICHIGAN	Detroit	Great Lakes Michigan Crane	<a href="http://www.michigancrane.com">www.michigancrane.com</a>	(313) 365-1800
	Farmington Hills	Detroit Power & Light	<a href="http://www.detroitpowerandlight.com">www.detroitpowerandlight.com</a>	(248) 476-3737
MINNESOTA	Brooklyn Park	Broadway Rental Equipment	<a href="http://www.broadwayrental.com">www.broadwayrental.com</a>	(763) 533-1680
	Shakopee	Ziegler Power Systems	<a href="http://www.zieglerinc.com">www.zieglerinc.com</a>	(612) 445-4292
MISSOURI	St. Louis	CK Power Products	<a href="http://www.ckpower.com">www.ckpower.com</a>	(314) 868-8620
NEVADA	Las Vegas	Plus One Rentals	<a href="http://www.plusonerentals.com">www.plusonerentals.com</a>	(844) 758-7100
	Reno	United Rentals	<a href="http://www.ur.com">www.ur.com</a>	(775) 789-6000
NEW JERSEY	Farmingdale	Risco	<a href="http://www.riscorv.com">www.riscorv.com</a>	(732) 872-7722
	Piscataway	CAT Entertainment Services	<a href="http://www.es-cat.com">www.es-cat.com</a>	(877) 456-7854
	South Plainfield	SBP Industries	<a href="http://www.sbp4juice.com">www.sbp4juice.com</a>	(908) 412-8630
NEW MEXICO	Santa Fe	Serious Grippage & Light	<a href="http://www.seriousgrippage.com">www.seriousgrippage.com</a>	(505) 473-1566
NEW YORK	Albany	FastLights	<a href="http://www.fastlights.com">www.fastlights.com</a>	(855) 922-5600
	Deer Park	RANTECH	<a href="http://www.OneStopSurplus.com">www.OneStopSurplus.com</a>	(631) 983-8408
	Hicksville	Abbey Rent-All	<a href="http://www.abbeyrent.com">www.abbeyrent.com</a>	(516) 681-1323
	Hicksville	Sunbelt Rentals	<a href="http://www.sunbeltrentals.com">www.sunbeltrentals.com</a>	(800) 667-9328
	Long Island City	Available Light	<a href="http://www.alny.net">www.alny.net</a>	(718) 707-9670
	Long Island City	Silvertrucks Lighting	<a href="http://www.silvercupstudios.com">www.silvercupstudios.com</a>	(718) 906-3045
	New Paltz	Stark Lighting & Generator	<a href="http://www.starklighting.com">www.starklighting.com</a>	(347) 538-6501
	New Rochelle	Tri-state Electric	<a href="http://www.tri-state-electric.com">www.tri-state-electric.com</a>	(866) 947-3252
	New York	Zircon Production Vehicles	<a href="http://www.zirconproductionvehicles.com">www.zirconproductionvehicles.com</a>	(888) 675-9995
NORTH CAROLINA	Denver	Cooke Rentals	<a href="http://www.cookerentals.com">www.cookerentals.com</a>	(704) 483-2722
	Wilmington	Gregory Poole Equipment	<a href="http://www.gregorypoole.com">www.gregorypoole.com</a>	(910) 371-6301
OKLAHOMA	Oklahoma City	Toucan Productions	<a href="http://www.toucanlighting.com">www.toucanlighting.com</a>	(405) 943-9036
OREGON	Portland	Peterson Caterpillar	<a href="http://www.petersoncat.com">www.petersoncat.com</a>	(503) 288-6411
PENNSYLVANIA	Havertown	Gaffer Baron	<a href="http://www.gafferbaron.com">www.gafferbaron.com</a>	(610) 449-6550
RHODE ISLAND	North Kingstown	CAT Entertainment Services	<a href="http://www.es-cat.com">www.es-cat.com</a>	(888) 296-4492
SOUTH CAROLINA	Charleston	High Output - Charleston	<a href="http://www.highoutputcharleston.com">www.highoutputcharleston.com</a>	(843) 722-3600
	Charleston	Neff Rental	<a href="http://www.neffrental.com">www.neffrental.com</a>	(843) 760-6333
	Charleston	Paladin Equipment Rentals		(843) 819-6401
TENNESSEE	Franklin	Cine Power Systems	<a href="http://www.cinepowersystems.com">www.cinepowersystems.com</a>	(615) 521-6857
	Knoxville	The Smoky Mountain Grip & Lighting Co.	<a href="http://www.smokymtngrip.com">www.smokymtngrip.com</a>	(865) 947-5483
	Nashville	Sunbelt Rentals Pump & Power Services	<a href="http://www.sunbeltrentals.com">www.sunbeltrentals.com</a>	(615) 838-2854
TEXAS	Dallas	CAT Entertainment Services	<a href="http://www.es-cat.com">www.es-cat.com</a>	(888) 908-4228
	Fort Worth	Jeff Watts Productions	<a href="http://www.jwproductions.org">www.jwproductions.org</a>	(817) 439-2353
	Houston	Juice Goose / Whitenon Industries	<a href="http://www.juicegoose.com">www.juicegoose.com</a>	(713) 772-1404
	Houston	Portable Power USA	<a href="http://www.nov.com/portablepower">www.nov.com/portablepower</a>	(800) 256-1924
	Houston	The Lighting Zone	<a href="http://www.thelightingzoneinc.com">www.thelightingzoneinc.com</a>	(713) 923-4188
	Irving	Panavision - Dallas	<a href="http://www.panavision.com">www.panavision.com</a>	(972) 929-8585
	Rowlett	Burrell Enterprises	<a href="http://www.litepower.com">www.litepower.com</a>	(972) 475-8111
	Spring	Aggreko	<a href="http://www.aggreko.com">www.aggreko.com</a>	(281) 298-9151
UTAH	Salt Lake City	Production RVs & Base Camps	<a href="http://www.mullethomes.com">www.mullethomes.com</a>	(801) 699-5409
VERMONT	Burlington	FastLights	<a href="http://www.fastlights.com">www.fastlights.com</a>	(855) 922-5600
	Hinesburg	NRG Systems	<a href="http://www.nrgsystems.com">www.nrgsystems.com</a>	(802) 482-2255
VIRGINIA	Richmond	Temp Power & Annapolis Mobile Power Services	<a href="http://www.annapolismobilepower.com">www.annapolismobilepower.com</a>	(804) 308-3414
WASHINGTON	Seattle	Pacific Grip & Lighting	<a href="http://www.pacific-grip.com">www.pacific-grip.com</a>	(206) 622-8540
WISCONSIN	Madison	Red Star Pictures	<a href="http://www.redstarpictures.com">www.redstarpictures.com</a>	(855) 522-5272



interxion™

# THE NEW WORLD OF SPORTS DISTRIBUTION

Distribution of sports content is changing. Fans expect total access to their sport before, during and after the game. Maximise your reach via our highly connected data centres.



Join Interxion at the SVG Summit to learn more about the benefits of collocated hybrid cloud. We will be attending other SVG events across the US and Europe. We look forward to meeting you soon.

[www.interxion.com](http://www.interxion.com)

Interxion, colocation data centre services provider – **40+ data centres** across **11 countries** in Europe.

# STATS

**PASSION.  
PRECISION.  
VELOCITY.**™

For over 35 years,  
STATS has powered  
sports broadcasts with  
data-driven insights

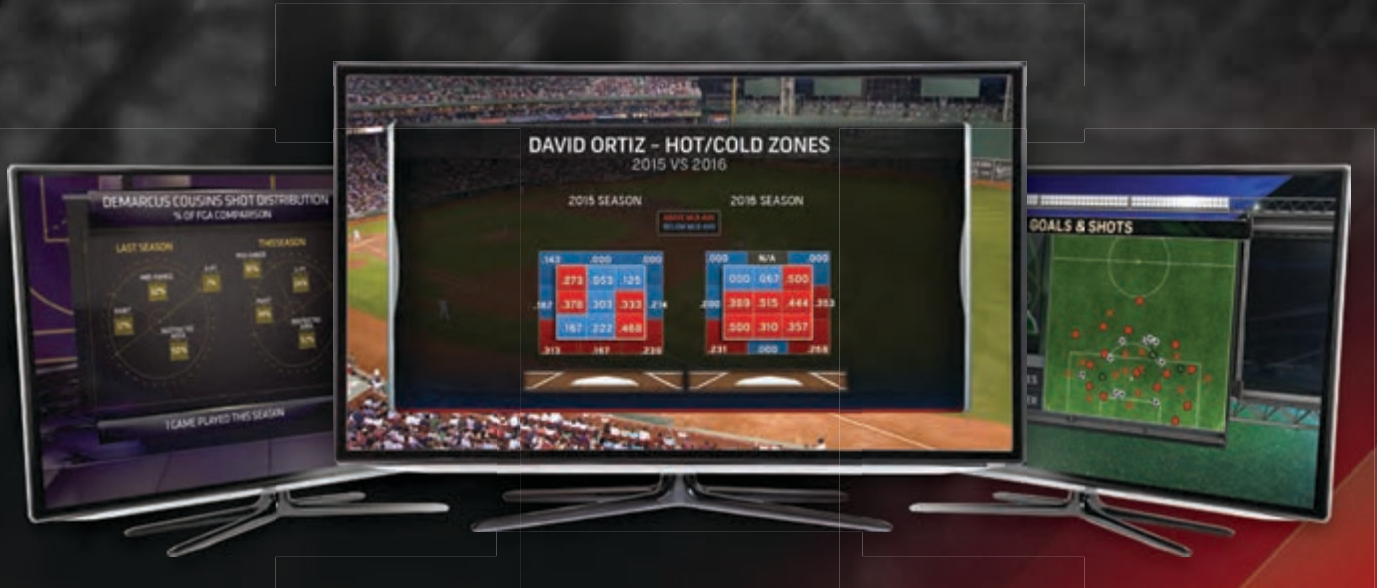

**3 Billion +**

Fans reached each month



**83,000 +**

Events covered per year



**800 +**

Global strategic clients



**600 +**

Leagues coverage worldwide

**Learn more at [STATS.COM](http://STATS.COM)**



THE EASY WAY TO RELIABLY AND SECURELY  
**SEND ANY SIZE FILE, ANYWHERE, *FAST.***

SIMPLE

GLOBAL

FAST

SECURE

LEARN MORE AT [WWW.SIGNIANT.COM/MEDIASHUTTLE](http://WWW.SIGNIANT.COM/MEDIASHUTTLE)

**ABOUT MEDIA SHUTTLE**

Media Shuttle is an easy-to-use, fast and secure file sharing solution that media and entertainment organizations rely on to send their largest files anywhere. A subscription based file-transfer solution, Media Shuttle is delivered with Signiant's patented hybrid SaaS architecture—a highly innovative use of Amazon's IaaS platform. With Media Shuttle, clients can choose to store content files on-premises or in managed cloud storage, while the software that handles all the file logistics is always hosted and managed in the cloud by Signiant. Learn more at [www.signiant.com/mediashuttle](http://www.signiant.com/mediashuttle)



+1.781.221.4051 | [WWW.SIGNIANT.COM](http://WWW.SIGNIANT.COM)





# DON'T LET YOUR CONTENT EXPIRE

As we experience a renaissance in the distribution & consumption of rich media, essentially all of the world's audiovisual content is at risk. From newly produced programs to legacy film & tape assets, in the absence of a preservation strategy your valuable content will expire.

## LET IT LIVE

Our years of experience have shown us that no off-the-shelf product meets all the needs of audiovisual preservation.

We provide the most professional and comprehensive solutions to the challenge of preserving and accessing media collections. Let your content live forever.



**CRAWFORD**  
MEDIA SERVICES, INC.

For more information about our media management solutions, email us at [info@crawford.com](mailto:info@crawford.com)

[go.crawford.com/svg](http://go.crawford.com/svg) | 404.876.0333

# IMAGINE THE POSSIBILITIES

**ZIXI** Revolutionizing IP Video

Perfect picture, Blazing fast, Infinite reach

The Zixi Platform is a cloud-based, server-based, or hybrid software solution that delivers live, broadcast-quality video over standard unmanaged Internet connections with total reliability and the highest-security protection. The Zixi Platform makes it easy to scale the use of IP video and can be configured in numerous ways to meet the needs of any sized business.

## Cloud-based software platform for live IP video transmission



Blazing  
fast



Perfect  
picture



Intelligent



Always on



Simple



Agile



Secure



Infinite  
reach



Scalable

The Zixi Platform addresses the industry's biggest challenges, making it possible for media organizations to extend their reach, increase their production speed, and reduce operational costs.



Discover the Zixi Platform now at [www.zixi.com](http://www.zixi.com)

# Mobile Production Units

STATE	CITY	COMPANY NAME	WEBSITE	PHONE
ALABAMA	Alabaster	Crosscreek Television Productions	www.crosscreektv.com	(727) 530-5000
	Daphne	AVS Media Group	www.avsmediagroup.com	(251) 621-1200
	Montgomery	Dan Black Studios	www.danblackstudios.com	(334) 279-6036
ARIZONA	Mesa	Suite Event Rentals	www.suiteeventrentals.com	(480) 461-0023
	Phoenix	Cox Studios- Phoenix	www.coxcreativestudios.com	(623) 328-4778
	Phoenix	FLOODstream	www.floodstream.com	(480) 535-5002
ARKANSAS	Phoenix	Skyline Productions	www.skylinevideo.com	(480) 345-8009
	Little Rock	Hailstone Creek Productions	www.hailstonecreek.com	(501) 371-9515
	North Little Rock	Jones Mobile Television	www.jmtv.com	(501) 376-1993
CALIFORNIA	Rogers	Clark's Video Group	www.clarksvideogroup.com	(479) 636-7111
	Anaheim	Southern Sky Satellite	www.southernskysatellite.com	(714) 974-1518
	Burbank	Apache Rental Group	www.apacherentalgroup.com	(818) 842-9944
	Burbank	Broadcast Management Group	www.broadcastmgmt.com	(310) 807-4635
	Burbank	Pacifico Television Engineering	www.pacificobroadcast.com	(818) 566-9706
	Burbank	Touring Video	www.touringvideo.com	(818) 504-3500
	Chatsworth	Cinerep International	www.cinerepamps.com	(818) 882-2677
	Concord	E-N-G Mobile Systems	www.e-n-g.com	(800) 662-4522
	Costa Mesa	OC Production Truck	www.orangecountyproductiontruck.com	(949) 515-0100
	Diamond Bar	21 Lakes Media Group	www.21lakes.com	(951) 515-1519
	Joshua Tree	Mojave Film Services		(760) 799-4414
	Los Angeles	Cinelease	www.cinelease.com	(855) 441-5500
	Los Angeles	Flying Cow Satellite Services	www.flyingcowsat.com	(310) 372-4759
	Los Angeles	Studio Production Center	www.studioproductioncenter.com	(323) 344-3500
	Los Angeles	Pacific Satellite	www.pacificsat.com	(510) 918-3909
	Los Angeles	Sharp Eye Industries	www.sharpeyehd.com	(866) 964-7474
	Los Angeles	SoHo Coaches & Catering	www.sohocoaches.com	(310) 272-6467
	Morgan Hill	Global Link Productions	www.globalinktv.com	(408) 465-2787
	Norwalk	UniSat: Universal Satellite Communications	www.unisatmobile.com	(562) 483-4800
	Ripon	MS Production Services		(877) 354-6777
SACRAMENTO	Sacramento	PACSAT - California	www.pacsat.com	(800) 672-2728
	San Carlos	Bay Area Mobile Production	www.bamphd.com	(650) 740-5856
	San Diego	Satellite Digital Teleproductions (SDTV)	www.sdtv.com	(619) 293-7777
	San Diego	SWATV Entertainment	www.swatv.com	(619) 567-9288
	San Francisco	Cresco Production Express	www.crescorent.com	(415) 920-2801
	San Francisco	Pacific Satellite	www.pacificsat.com	(510) 918-3909
	Santa Monica	Mobeon	www.mobeon.com	(888) 789-2463
	Studio City	Digital Media Group	www.digitalmedia.tv	(818) 974-4000
	Studio City	Streaming Media Live	www.streamingmedialive.com	(818) 974-4000
	Sunland	Schulman Mobile Video	www.schulmanmv.com	(323) 785-2528
	Torrance	Hollywood Riviera Studios	www.hollywoodrivierastudios.com	(310) 237-5653
	Vacaville	Mobilized Tech Systems - Bigfoot Mobile Systems	www.bigfootmobilecarts.com	(888) 293-0869
VAN NUYS	Van Nuys	PSSI Global Services - Strategic Television	www.pssiglobal.com	(310) 575-4400
	Denver	Denver Media Center	www.denvermediacenter.com	(720) 255-1640
COLORADO	Englewood	Slipstream Media		(303) 353-9425
	Milford	Conover Production Services	www.conover.net	(203) 877-5427
CONNECTICUT	Milford	Conover Production Services	www.conover.net	(203) 877-5427
DISTRICT OF COLUMBIA	Washington	Mobile Video Services	www.mobilevideo.net	(202) 331-8882
	Washington	Skehan Communications	www.skehan.com	(202) 833-3310
FLORIDA	Boca Raton	Mobile Studios	www.mobilestudios.com	(561) 372-0604
	Cape Canaveral	Communications Concepts	www.ccflorida.com	(321) 783-5232
	Clearwater	F & F Productions	www.fandfproductions.com	(727) 530-5000

\*All information is subject to change. For the most current contact information, please visit [www.productionhub.com](http://www.productionhub.com)

# TRACK TO TABLET WITHOUT TROUBLE

Live sports networks demand reliability and speed of transmission with no drop out during live stream.

That's why they need the Tata Communications Media Ecosystem. It's the world's first all-in-one global video content delivery solution. Its end-to-end cloud-based platform gives a unique connection from live event broadcast to editing and distribution. You're able to integrate every part and partner in the process, as we do with Formula 1 live broadcasts every race weekend. From viewfinder to viewer and everything in between, it's the perfect solution for the sports network that has to deliver the action to the fans without losing a second.

Find out more at [tatacommunications.com/mediaecosystem](http://tatacommunications.com/mediaecosystem)



# Real-time Interactive Broadcast

TokBox enables you to embed large scale interactive broadcast experiences into your web & mobile applications.

## Benefits

- ✓ Increased reach & audience engagement
- ✓ Easy to embed
- ✓ Flexible content creation
- ✓ Web & mobile interoperability

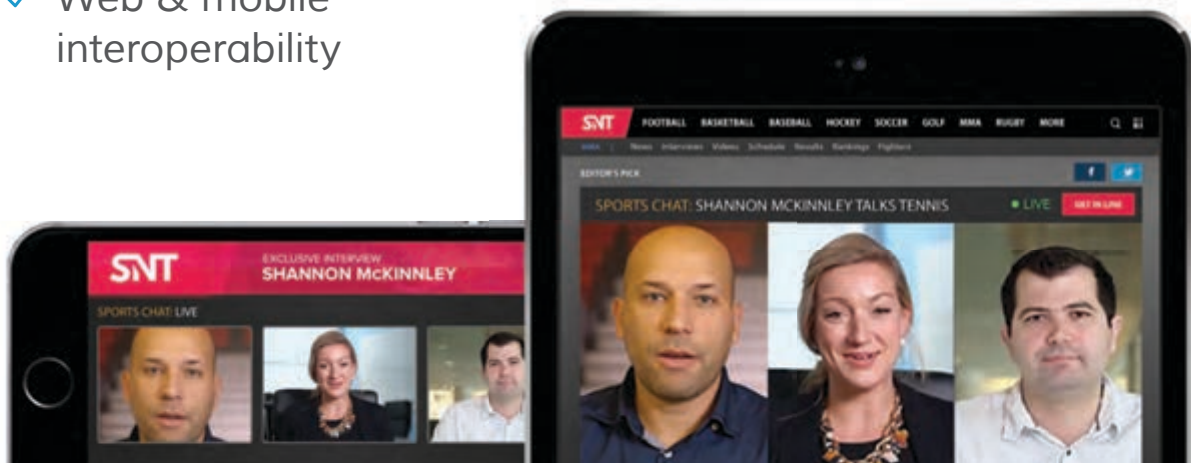

FIND OUT MORE

[bizdev@tokbox.com](mailto:bizdev@tokbox.com) | [www.tokbox.com](http://www.tokbox.com)



## Uncompressed KVM and Video Signal Extension and Switching for Remote Broadcast Production Trucks

Up to 4K@60Hz 4:4:4 30 bits per pixel



- **Modular Hybrid Fiber and CATx KVM**  
Flexible – Reliable – Space Saving
- **Easy Access and Fast Reconfiguration**  
Redundant – Hot Swappable – Resilient
- **Supports All Signal Formats**  
HD – UHD – 2K – 4K – SDI – DVI – VGA – Audio – RS232/422
- **Seamless Integration and True "Any-to-Any" Switching**  
EVS Replay – Any Application to Any Workstation
- **High Bandwidth – Up to 10Gbps**  
No Compression – No Latency – No Loss of Video Quality
- **Made in USA Quality and Support**

*The Worldwide Leader for Secure, High-Performance KVM and Video Extension and Switching Solutions*

[www.thinklogical.com](http://www.thinklogical.com)  
[info@thinklogical.com](mailto:info@thinklogical.com)  
800.291.3211





[www.rockitcargo.com](http://www.rockitcargo.com)



**PROUD  
CORPORATE  
SPONSOR**

# Change Up Your Video Game Plan



## CHESA

chesapeake systems

At Chesapeake Systems, we're able to step back and see the bigger picture. We analyze how you work, determine your pain points and bottlenecks and then we design and deploy a system that will enhance your data storage capabilities and streamline your workflow.

Our team is made up of industry experts who have experience working with a variety of organizations from collegiate sports to the NFL.

### STORAGE

Chesapeake Systems provides sports and media organizations the storage capabilities and collaborative video workflow solutions they need.

### ACCESSIBILITY

We know there are scores of individuals involved in game day shooting, editing, sharing and archiving tremendous amounts of footage and it needs to be immediately accessible.

### WORKFLOW

We are prepared to provide the right workflow solution for you. We have established strong relationships with leading hardware and software vendors to help meet your needs and budget.

Ready to transform the way you work?

[chesa.com](http://chesa.com)



Media Asset Management (MAM) is complex and the MAM vendor landscape is vast. Visit [chesa.com/e-book-mam-rescue](http://chesa.com/e-book-mam-rescue) to download our **FREE E-Book** and let us be your resource.

## Mobile Production Units

STATE	CITY	COMPANY NAME	WEBSITE	PHONE	
FLORIDA	Clearwater	Frontline Communications	www.frontlinecomm.com	(727) 573-0400	
	Clearwater	Oshkosh Specialty Vehicles	www.oshkoshsv.com	(727) 573-0400	
	Fort Lauderdale	MSR Mobile Stage Rentals	www.mobilestagerentals.com	(877) 882-8889	
	Fort Lauderdale	Ross Mobile Productions	www.rossmp.com	(954) 769-1109	
	Lake Mary	Skystorm Productions	www.skystorm.com	(407) 328-4747	
	Miami	Christian Media Group	www.cmgsows.com	(786) 286-4942	
	Miami	MMC Video	www.mmcvideocorp.com	(305) 300-8976	
	Miami	Tfactor Mobile Television	www.tfactor.tv	(305) 597-0430	
	Miami	UNITED TELEPORTS	www.unitedteleports.com	(305) 671-3333	
	Miami Beach	Encanta Productions	www.encanta.com	(305) 673-5958	
	Miami Beach	Mirikesh Production Motorcoach & Trailer	www.mirikesh.com	(786) 295-3969	
	Orlando	First Call Location Coach Rentals	www.firstcallcoach.com	(407) 832-2606	
	Orlando	Orbital Communications	www.orbitalcom.tv	(800) 682-4364	
	Orlando	Spectrum Productions	www.spectrumproductions.com	(800) 358-2704	
	Orlando	TMR Television Mobile Resources	www.tvmr.com	(407) 737-0046	
	St. Petersburg	The Zoo Studios	www.thezoostudios.net	(727) 350-5962	
	Tampa	FlyMotion Media	www.flymotionmedia.com (media division); www.flymotionus.com (unmanned systems division)	(800) 548-5844	
	West Palm Beach	National Teleproductions		(561) 689-9271	
	GEORGIA	Atlanta	Encompass Digital Media	www.encompass.tv	(678) 421-6600
		Atlanta	Inertia Films	www.inertiafilms.com	(404) 681-3900
Atlanta		KEF Media Associates	www.kefmedia.com	(404) 605-0009	
Atlanta		Narrow Path Productions	www.narrowpath.tv	(770) 704-8000	
Atlanta		Two Roads Video	www.tworoadsvideo.com	(704) 975-5061	
Jasper		Talking Rock Communications	www.talkingrockcommunications.com	(706) 692-6450	
Lawrenceville		Lightnin' Production Rentals	www.lightnin.net	(770) 963-1234	
Lilburn		Gunner Live	www.gunnerlive.com	(678) 313-6001	
HAWAII	Hawi	Keith Nealy Productions	www.keithnealy.com	(808) 882-7772	
	Honolulu	John Guild Communications	www.john-guild.com	(808) 596-2211	
	Kapolei	George Cambra Movie Production Trucks		(808) 845-1546	
	Mililani	Ron Eggleton	www.xleggs.com	(360) 790-1459	
ILLINOIS	Chicago	Trio Video	www.triovideo.com	(312) 421-7060	
	Crystal Lake	Satellite Technology Systems	www.stslivetv.com	(800) 838-1472	
	Monee	Advanced Mobility Specialty Vehicles	www.amstcorp.com	(708) 235-2800	
	Mount Prospect	Chicago Visual	www.chicagovisual.com	(847) 857-7769	
	Peoria	ScheffTech Productions	www.schefftech.com	(309) 524-5865	
	Tinley Park	Digital Impact Video	www.digitalimpactvideo.com	(708) 606-2310	
INDIANA	Hammond	Kentucky Trailer	www.kytrailer.com	(219) 845-1695	
	Merrillville	Lakeshore Productions	www.lakeshoreproduction.com	(219) 756-5656	
	Mishawaka	CVM Productions	www.cvmproductions.com	(574) 256-0068	
	Muncie	WIPB Productions	www.wipbproductions.com	(765) 285-1625	
	Noblesville	LeSEA Productions	www.leseaproductions.com	(317) 773-5050	
	Noblesville	TV40Productions	www.whmbtv.com	(317) 773-5050	
South Bend	LeSEA Productions	www.leseaproductions.com	(574) 291-8200		
KANSAS	Olathe	Freebird Communications	www.freebirdtv.com	(913) 209-2788	
LOUISIANA	Baton Rouge	HD Mobile Production Truck	beta.lpb.org/index.php/site/truck	(225) 767-4220	
	New Orleans	Satellite Center	www.satctr.com	(504) 915-8244	
	New Orleans	YES Productions	www.yesproductions.org	(800) 736-8812	
	West Monroe	ShowCase Video	www.showcasevp.com	(318) 398-0748	
MAINE	Saco	CSP Mobile Productions	www.cspmobil.com	(207) 282-9680	
MARYLAND	Phoenix	Sheffield Audio Video Productions	www.sheffieldav.com	(800) 355-6613	

# Rely on

For Award-Winning Systems Integration  
Plus Sales & Service For The Industry's Best Products



**It' up...it's looking good...and touchdown... project success!** Now reaching over 3 decades, CEI continues to make great plays, delivering world class consulting, system design, integration, training and maintenance services for broadcast, AV and multimedia projects including equipment supply from more than 500 of the world's leading manufacturers. From stadiums and mobile units to stations and networks, CEI builds the most awesome, award winning production and playout facilities for the most demanding competitors in the industry.

CEI blocks and tackles trouble with our comprehensive repair and support team including a full roster of full time, professional broadcast, audio-visual and IT engineers offering on-site and in-house repair and support services. CEI also offers training and customized maintenance contracts tailored to your facility's unique needs. We can even help with your old legacy gear!

Looking for a winning team for your next project?

You can rely on CEI!



Contact CEI Today:  
703-550-5800  
sales@commeng.com  
www.commeng.com



# VISTA WORLDLINK IS INTEGRATION

EMBRACING EMERGING TECHNOLOGY  
EVOLVING THE SPORTS PRODUCTION LANDSCAPE



**VENUE**

• • •

EFFICIENT ONSITE FOOTPRINT



**VISTA HQ**

• • •

BROADCAST FACILITY WITH  
FULL SERVICE PRODUCTION SUITES



**DOMESTIC & INTERNATIONAL  
DISTRIBUTION**

• • •

VIA FIBER, SATELLITE,  
IP TRANSPORTATION, OR STREAMING

CONTACT US TO FIND OUT MORE

**954.838.0900 • VISTAWORLDLINK.COM**



**HEVC Ultra HD Solutions**  
DECODE TRANSCODE ENCODE

[t-21.biz](http://t-21.biz)

# LIVEX



As a full-service production company, Live X designs, produces, and broadcasts live events for global brand leaders. We provide clients everything from creative concept development to graphics and animation, to live production, encoding, and streaming.

**LIVE BROADCAST**

**WIRELESS STREAMING**

**SYSTEM INTEGRATION**

**CUSTOM APPLICATIONS**

**PROJECTION MAPPING**

**POST PRODUCTION**

## Contact Us

 (844) GO-LIVEX

 [contact@livex.tv](mailto:contact@livex.tv)

 [livex.tv](http://livex.tv)

 483 10th Avenue  
Suite 310,  
NY, NY 10018





**The industry leader in  
live event tapeless workflow.**

**On location. On schedule. On budget.**

---

**[www.cmsi.tv](http://www.cmsi.tv) • (818) 847-7390**

**Avid • Premiere • EVS**

## Mobile Production Units

STATE	CITY	COMPANY NAME	WEBSITE	PHONE
MASSACHUSETTS	Avon	Technology Management	www.tmcycles.com	(800) 949-5424
	Hudson	D2 Productions	www.d2productions.com	(508) 485-0300
	Springfield	VideoPort Communications	www.videoportc.com	(413) 478-1745
	Wakefield	Remote Facilities Consulting Services	www.remotefacilities.com	(781) 246-8300
	Watertown	PixMix Video Services	www.pixmix.net	(617) 254-0590
MICHIGAN	Lansing	SCP Media	www.scp-media.com	(517) 507-0383
	Sterling Heights	Moonlink Satellite	www.moonlinksat.com	(586) 323-9590
	Wixom	Detroit Public Television	www.dptv.org/about/production-services/	(248) 305-3827
MINNESOTA	Coon Rapids	CTN Studios	www.ctnstudios.com	(763) 767-6525
	Minneapolis	Arctek HD Satellite Productions	www.arcteksat.com	(612) 623-1986
MISSOURI	Kansas City	Cashmark Media	www.cashmarkmedia.com	(816) 861-4200
	Springfield	TL Mobile Television	www.tlmobiletv.com	(417) 877-0025
	St. Louis	Spot Media Transfer	www.spotmpg.com/#deliver	(314) 667-5915
MONTANA	Helena	Lyon Productions	www.lyongroup.biz/content/	(406) 442-9014
NEVADA	Las Vegas	CoverEDGE	www.coveredge.com	(800) 822-NEWS
	Las Vegas	FLOODstream	www.floodstream.com	(702) 577-3300
	Las Vegas	RentLEDsigns.com	www.RentLEDsigns.com	(888) 920-4485
	Stateline	Shoot It Live	www.shootitlive.tv	(808) 371-3023
NEW HAMPSHIRE	Hudson	Game Creek Video	www.gamecreekvideo.com	(603) 882-5222
	Pelham	Thistle Communications	www.thistlecommunications.net	(603) 598-5100
NEW JERSEY	Hackensack	Patchamp	www.patchamp.com	(201) 457-1504
	Ramsey	Jim Houston Productions	www.njsportsvideos.com	(201) 825-7659
	Wayne	Vision Quest Productions	www.visionquestproductions.com	(973) 686-9400
	Whippany	A3 Media	www.a3mediallc.com	(201) 951-0619
NEW YORK	Baldwin	Flypack New York	www.FlypackNY.com	(516) 867-7300
	Buffalo	Admiral Video - InMotion HD	www.ImHD.tv	(716) 651-9900
	Flushing	Interface Communications	www.interfacetv.com	(718) 463-8700
	Flushing	Multi Media Network News	www.multimedianetworknews.com	(718) 809-7058
	New City	Flight 9 Satellite Services	www.flight9.com	(888) 354-4489
	New City	StreamByte TV Event Webcasting	www.streambyte.tv	(267) 382-0285
	New York	All Mobile Video (AMV)	www.allmobilevideo.com	(212) 727-1234
	New York	Broadcast Management Group	www.broadcastmgmt.com	(212) 784-6020
	New York	Cinedeck	www.cinedeck.com	(646) 747-0727
	New York	DS Simon Productions HD Television Studio	www.dssimon.com	(212) 736-2727
	New York	KoKo - Baz Video & Film	www.kokobaz.com	(212) 674-6601
	New York	Metrovision Production Group	www.metrovision.tv	(212) 989-1515
	New York	Remote Digital Media	www.remotedigitalmedia.com	(646) 536-7340
	Patchogue	Luna Video	www.vimeo.com/75588888	(631) 767-8817
	NORTH CAROLINA	Port Washington	ADM Productions	www.admproductions.com
Warwick		Centrex Communications	www.centrexcom.com	(845) 987-1666
West Babylon		Village Video News	www.vvn.com	(631) 752-9311
Charlotte		Aviv Moon Productions	www.avivmoon.tv	(704) 746-3974
OHIO	Charlotte	Control 1 Communications	www.control1comm.com	(205) 706-9524
	Raleigh	7 Communications	www.7commedia.com	(919) 332-1572
	Raleigh	On Location North Carolina Film & Video Equipment Services	www.onlocation-nc.com	(919) 755-9488
	Troutman	A&M Productions Southeast	www.amproductions.tv	(205) 566-2549
	Winston Salem	Spevco	www.spevco.com	(336) 924-8100
	Columbus	Lyon Video	www.lyonvideo.com	(614) 297-0001
OHIO	Columbus	Mobile Production Services	www.remoteriley.com	(614) 864-7900
	Poland	First Call UPLinks	www.firstcalluplinks.com	(800) 951-6707
	Sunbury	Bennett Systems	www.tvmobile.net	(740) 965-5727

EVERY  
MOVE



EVERY  
MOMENT



INSTANT REPLAY

# AT YOUR FINGERTIPS IN THE ARENA OR ON THE GO

TRUSTED PRO PERFORMANCE | STUDENT-FRIENDLY PRICING

tightrope media systems ★

[www.trms.com](http://www.trms.com)

# Professional AV Design and Broadcast Integration Services

Project Management

A/V Systems Engineering

A/V Systems Design

A/V Integration

A/V Programming

A/V Installation & Post-Installation



Specialized in all display types...the industry leader in LED display systems

140 MT. HOLLY BYPASS, UNIT #1, LUMBERTON, NJ 08048 | 609-531-2642 | WWW.AVDS.TV



**MASERGY**

Performance Beyond Expectations

# TRANSFORM YOUR BUSINESS With Smarter IT

**HYBRID  
NETWORKING**



**MANAGED  
SECURITY**



**CLOUD  
COMMUNICATIONS**



**Software-defined solutions that adapt to the shape of your business**

To learn more about our managed services or request a free consultation, visit  
[www.masergy.com/solutions](http://www.masergy.com/solutions)

Call us at **(866) 588-5885** or email [info@masergy.com](mailto:info@masergy.com)



**MAXIMIZE YOUR VENUE IPTV  
DIGITAL SIGNAGE INVESTMENT  
WITH CLEAR STRATEGY,  
DESIGN AND OPERATIONS  
IN YEAR ONE, TWO  
AND BEYOND.**

### **Digital Signage**

- Design & Installation
- Creative Services
- Live Stats Integration
- Video Wall Design
- Interactive Wayfinding
- Digital Menu Boards

### **Operational Services**

- Venue Content Strategy
- Game Day Operations
- Control Room System Design
- Sales Model Design
- IPTV Network Planning

**MOEBAM! VENUE MEDIA SERVICES, LLC  
P.O. BOX 951002 • LAKE MARY, FL 32746  
407-341-8542 • WWW.MOEBAM.COM**

# THE BSI HAT TRICK



## Great Shot. Great Production. Great Experience.

From home ice to home entertainment, BSI offers the very best in technical production, consulting and engineering services for major sporting events around the world. First, we capture the action. Second, we broadcast every pixel of it. Third, we bring it all home for the ultimate viewing experience.

With 18 Emmys to our credit, it's easy to see why over 20 Olympic games, 18 NBA Finals and 26 Masters tournaments have counted on BSI to deliver the "hat trick" of sportscasting excellence – with experienced production, top engineering and the right equipment.

Find out how we can deliver for you at [www.bsi-tv.com](http://www.bsi-tv.com)



**BROADCAST  
SERVICES  
INTERNATIONAL**

905.332.2171 | [www.bsi-tv.com](http://www.bsi-tv.com)

## Mobile Production Units

STATE	CITY	COMPANY NAME	WEBSITE	PHONE
	Sunbury	Gerling and Associates	www.gerlinggroup.com	(740) 965-2888
	Wapakoneta	Game Face Ohio	www.gamefaceohio.com	(419) 739-7720
OKLAHOMA	Broken Arrow	Allied Broadcast Group	www.alliedbroadcastgroup.com	(918) 250-5353
	Broken Arrow	Kodiak Mobile Television	www.kodiakmobile.tv	(918) 925-9877
	Tulsa	LeSEA Productions	www.leseaproductions.com	(918) 254-4701
	Tulsa	Winnercomm	www.winnercomm.com	(918) 496-1900
PENNSYLVANIA	Allentown	New Century Productions	www.nepinc.com/welcome/ncp	(888) 887-3627
	Boyetown	J A Taylor & Associates	www.broadcastassociates.com	(610) 754-6800
	Harrisburg	Capital Area Communications	www.cacradio.com	(717) 756-1870
	Harrisburg	Invica	www.invica.net	(717) 577-6601
	Harrisburg	Jump	www.multi-mediapros.com	(717) 324-3912
	Harrisburg	Media Solutions	www.mediamadeeasy.com	(877) 860-5255
	King Of Prussia	PMTV - Producers Management TeleVision	www.PMTV.com	(484) 690-9180
	Lancaster	Proviaus	www.proviaus.com	(717) 842-0440
	Malvern	CCI Communications	www.ccivideo.com	(610) 296-7233
	Philadelphia	StreamByte TV Event Webcasting - Philadelphia	www.streambyte.tv	(267) 382-0285
	Philadelphia	Total Production Services	www.tpsweb.com	(888) 877-1178
	Pittsburgh	NEP	www.nepinc.com	(855) 735-4310
	Pittsburgh	Viewpoint Production Services	www.viewpoint.tv	(800) 820-0402
SOUTH CAROLINA	Myrtle Beach	Satellite Papa	www.satellitepapa.com	(843) 333-5963
TENNESSEE	Gallatin	Brightlink HD	www.BrightlinkHD.com	(615) 289-4319
	Goodlettsville	Video One Productions	www.vopinc.com	(615) 859-1521
	Hendersonville	Camp Digital	www.campdigital.net	(615) 826-0122
	Hendersonville	Stokes Production Services	www.stokesvideo.com	(615) 822-6500
	Memphis	KNO Productions	www.knoproductions.com	(901) 729-8770
	Murfreesboro	Tennessee Digital Video	www.tndv.com	(877) 959-8638
	Nashville	Concerto HD	www.ConcertoHD.com	(615) 481-0502
	Nashville	Tennessee Digital Video	www.tndv.com	(877) 959-8638
TEXAS	Argyle	GoVision	www.jumbo.tv/home.html	(940) 464-2320
	Austin	Earl Miller Productions	www.earlmillerproductions.com	(512) 458-4343
	Dallas	Texas TV Trucks	www.TexasTVTrucks.com	(972) 570-1118
	Dallas	Tricam Video Productions	www.tricamvideo.com	(817) 909-4137
	Haslet	Jeff Watts Productions	www.jwproductions.org	(817) 233-6462
	Houston	Advanced Containment Systems (ACSI)	www.acsi-us.com	(713) 987-0336
	Houston	Satellite Center	www.satctr.com	(504) 915-8244
	Missouri City	Stage2screenProductions	www.stage2screenproductions.com	(281) 804-9525
	Waco	TriVan Truck Body	www.trivan.com	(866) 874-8261
UTAH	Salt Lake City	Production RVs & Base Camps	www.mullethomes.com	(801) 699-5409
	Sandy	Videolines Mobile Television	www.videolinesmobiletv.com	(801) 580-9474
VIRGINIA	Springfield	Glass River Media	www.glassrivermedia.com	(800) 446-7905
	Williamsburg	Colonial Williamsburg Productions	www.history.org/productions	(757) 869-6922
WASHINGTON	Bothell	Northwest Mobile Video	www.nwmobile.video	(360) 747-7383
	Seattle	Fremont Studios	www.fremontstudios.com	(206) 408-5113
	Seattle	LDM Worldwide Productions	www.ldmworldwide.com	(206) 463-1902
WISCONSIN	Milwaukee	Link Up Communications	www.linkupcom.com	(866) 435-8008
	Waunakee	Token Creek Mobile Television	www.tokencreek.com	(608) 849-4965



# WORKFLOW



CINESYS-OCEANA

**Customize. Integrate. Support.**

CineSys-Oceana specializes in workflow design and custom integrations, providing our customers with top of the line end to end solutions, including products, installation, training and support.

We create solutions tailored to your needs, allowing you to focus on the creative.

[cinesysoceana.com](http://cinesysoceana.com)

Atlanta . Chicago . Dallas . Houston . Miami . New York . Toronto



History making television since 1981



Aerials - HD Wireless - Communications - POV Cameras - RF Support Trucks

[www.aerialvideo.com](http://www.aerialvideo.com)

818.954.8842



# VIRTUAL, MEET REALITY



Gamer, fan and sponsor expectations are higher than ever when it comes to immersive eSporting experiences. They expect to engage with augmented and virtual reality (AR/VR), dynamic data visualization, social and custom-branded experiences.

AerNow's eSports platform is built on the real-time Core Live Operating Ecosystem (CLOE), delivering rich, immersive experiences that keep audiences engaged in live gaming on every device. Integrated dynamic advertising, syndication, sponsorship and branding features in CLOE's experience builder enable automated workflows for creating compelling content with seamless monetization tools, delivering ROI.



# Don't let fiber slow you down!

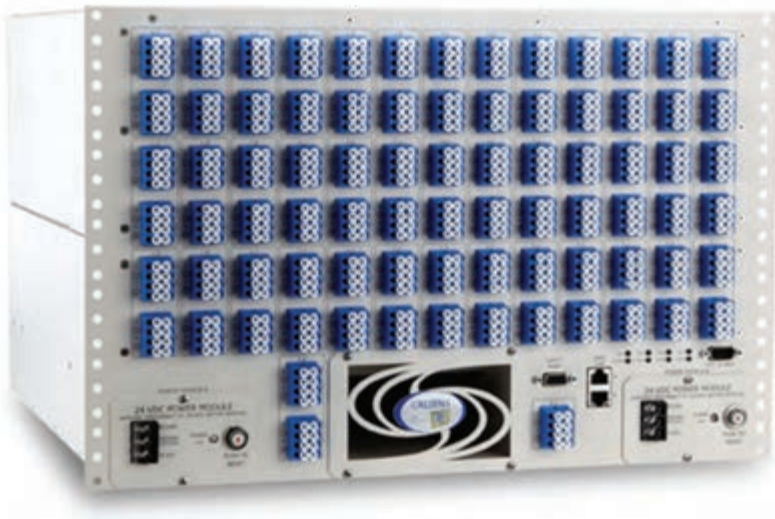

- Remotely patch optical video feeds in real time
- All-optical switch supports any speed, resolution, frame rate or protocol
- Seamlessly integrated with industry leading controllers

## Move the light, not the fiber™

### ABOUT CALIENT Technologies

CALIENT Technologies is the global leader in Optical Circuit Switching, providing systems that enable dynamic optical layer optimization in mobile studios and production facilities. CALIENT's 3D MEMS switches have demonstrated years of reliability; and with more than 500,000 optical terminations shipped, CALIENT has one of the largest installed bases of photonic switches worldwide.



[www.calient.net](http://www.calient.net) • [sales@calient.net](mailto:sales@calient.net) • +1 805.562.5500



[www.sonovts.com](http://www.sonovts.com)

# KICK-OFF.

Whether state-of-the-art TV productions or audience focused live events, our wide range of **rental equipment** will offer everything you need to create unforgettable sports moments on television.



**sonovts**  
ENVISION THE NEXT

# Satellite Trucks

STATE	CITY	COMPANY NAME	WEBSITE	PHONE	
ARIZONA	Chandler	ATCI Antenna Technology Communications	www.atci.net	(480) 844-8501	
	Phoenix	Crew West	www.crewwestinc.com	(888) 444-2739	
CALIFORNIA	Anaheim	Southern Sky Satellite	www.southernskysatellite.com	(714) 315-7478	
	Burbank	Broadcast Management Group	www.broadcastmgmt.com	(310) 807-4635	
	Calabasas	Coastal Media Group	www.coastalmediagroup.com	(818) 880-9800	
	Concord	E-N-G Mobile Systems	www.e-n-g.com	(800) 662-4522	
	Montecito	CBTV West	www.cbtvhd.com	(866) 728-3375	
	Morgan Hill	Global Link Productions	www.globalinktv.com	(408) 465-2787	
	Norwalk	UniSat: Universal Satellite Communications	www.unisatmobile.com	(562) 483-4800	
	Oakland	Central Coast Uplink	www.centralcoastuplink.com	(831) 325-5271	
	Sacramento	PACSAT	www.pacsat.com	(800) 672-2728	
	San Diego	Hurst USA		(619) 277-9990	
	San Juan Capistrano	Todocast	www.todocast.tv	(866) 510-7889	
	Santa Barbara	Rough House Productions	www.roughhousehd.com	(800) 626-2490	
	Studio City	Streaming Media Live	www.streamingmedialive.com	(818) 974-4000	
	Sun Valley	Panarex Electronics	www.manta.com/c/mmlldjts/panarex-electronic	(818) 768-5161	
	Sunland	Schulman Mobile Video	www.schulmanmv.com	(323) 785-2528	
	CONNECTICUT	Shelton	Vitec Videocom	www.vitecvideocom.com	(203) 929-1100
		Stamford	Newtec America	www.newtec.be	(203) 323-0042
	DISTRICT OF COLUMBIA	Washington	Broadcast Management Group	www.broadcastmgmt.com	(202) 609-7757
Washington		Ihlas News Agency	www.ihla.tv/ihla-washington-dc/20/washington/29	(202) 853-7914	
Washington		Media X Presentations	www.mxpil.com	(888) 873-6974	
Washington		NPR Satellite Services	www.nprss.org	(202) 513-2626	
Washington		Skehan Communications	www.skehan.com	(202) 833-3310	
FLORIDA	Clearwater	F & F Productions	www.fandfproductions.com	(727) 530-5000	
	Clearwater	Frontline Communications	www.frontlinecomm.com	(727) 573-0400	
	Dania	Calhoun Satellite Communications	www.calhounsatellite.com	(305) 655-2629	
	Lakeland	Crew West, Inc. /Satellink Communication Service	www.satellinkwest.com	(863) 698-4313	
	Largo	Advanced Microwave Components	www.advancedmicrowave.com	(727) 571-1008	
	Miami	GLASAT.com	www.glasat.com	(786) 210-2235	
	Miami	Overon America	www.overonamerica.com	(877) 476-8556	
	Miami	UNITED TELEPORTS	www.unitedteleports.com	(305) 671-3333	
	Orlando	Lowery Satellite Services	www.lowerysatellite.com	(407) 859-7940	
	Orlando	MobileCast-Live	www.mobilecast-live.com	(407) 376-8379	
	Orlando	Telepoint Studios	www.telepointstudios.com	(407) 859-7940	
FLORIDA	Orlando	TMR Television Mobile Resources	www.tvmr.com	(407) 737-0046	
GEORGIA	Atlanta	Encompass Digital Media	www.encompass.tv	(678) 421-6600	
	Atlanta	Two Roads Video	www.tworoadsvideo.com	(704) 975-5061	
	Jasper	Talking Rock Communications	www.talkingrockcommunications.com	(706) 692-6450	
	Lilburn	Gunner Live	www.gunnerlive.com	(678) 313-6001	
ILLINOIS	Crystal Lake	Satellite Technology Systems	www.stslivetv.com	(800) 838-1472	
	Peoria	WTVP	www.wtvpvideo.org	(309) 677-4747	
	Wauconda	Satellite Communication Systems	www.1800usalink.com	(847) 556-1056	
INDIANA	Noblesville	LeSEA Productions	www.leseaproductions.com	(317) 773-5050	
	South Bend	LeSEA Productions	www.leseaproductions.com	(574) 291-8200	
IOWA	Mason City	Efficient Antenna Systems	www.easisat.com	(888) 327-4797	
	Waterloo	Baird Satellite Supporting Systems	www.bairdsatellitesupports.com	(319) 233-3561	
KANSAS	Shawnee	Satellite Engineering Group	www.sateng.com	(800) 932-1555	
KENTUCKY	Florence	Nickless Shirmer & Co.	www.nsc.com	(800) 543-1584	
LOUISIANA	New Orleans	LeSEA Productions	www.leseaproductions.com	(504) 681-0120	
MARYLAND	Point Of Rocks	LiveOnSite	www.liveonsite.com/	(703) 431-4332	
	Potomac	Asia Broadcast	www.absatellite.net	(301) 605-7629	
MASSACHUSETTS	Ashland	Remote Broadcast Services	www.RemoteBroadcastServices.com	(201) 312-5531	
	Bedford	Polatis	www.polatis.com	(781) 275-5080	
	Hudson	D2 Productions	www.d2productions.com	(508) 485-0300	
	Wakefield	Remote Facilities Consulting Services	www.remotefacilities.com	(781) 246-8300	



## KNOWLEDGE • EXPERIENCE • CONFIDENCE

CBT Systems is a broadcast television and video productions facility design, engineering, and integration firm whose commitment to the industry has been demonstrated time and again over 19 years of business. CBT Systems has built a reputation for providing systems of the finest quality and performance by completing projects demanding imagination, innovation, and precision. CBT Systems is a pioneer in the concept of Advanced Systems Integration, using the knowledge gained in building state-of-the-art facilities to conceive hardware and software solutions to glue rapidly advancing sub-system technologies together.

Use CBT Systems to consult at the conception of your project to assist in facilities and site evaluation, to create advanced technical specifications and documentation, to conduct efficient and accurate systems installation.



### ADVANCED SYSTEMS INTEGRATION

Broadcast and Video Production facilities are far from plug and play. Integration is more than hooking up boxes with traditional cable and connectors, but rather the melding together of advanced hardware and software technologies to make the user interfaces intuitive to learn, and easy to use. CBT Systems embraces the philosophy of constant evaluation of products and solutions to select the correct systems for your application.

**Visit us at [cbtsystems.tv](http://cbtsystems.tv) to view our Project Portfolio.**

Let everyone know you are "ON-AIR"  
with a CBT Systems classic ON-AIR Light.

Custom Legends Available  
Power Requirement: 120V AC, 24/12V AC/DC  
Optional LED Lighting  
Mounts on a Single/Double Gang J-Box or Wall  
Dimensions - 14 1/4" H x 2 5/8" W x 4" D  
Approximate Weight 4 Pounds



# BEYOND TALLY



TSI-4000 TALLY CONTROLLER



REAR MOUNTED AUTO CHANGE OVER  
REDUNDANCY IN 2 RACK UNITS



TXI SERIES 16 / 48 / 80 GPI's PER FRAME



TXP-16  
SOFT CONFIGURABLE IN / OUT - WET / DRY





TAG the play.  
LOG the play.  
FIND the play.  
**WIN the game.**



CONTACT JB&A: 415.256.2800 ■ [sales@jbanda.com](mailto:sales@jbanda.com)



*'Building Business Relationships'*



## Experts in Video & Digital Media

Making media management simple, JB&A has assembled powerful technologies to enable your franchise to **MANAGE, ACCESS** and **PROTECT** your digital media.

<b>MANAGE:</b>	Optimize your assets - maximize their value
<b>ACCESS:</b>	Unlock the true potential of your archive
<b>PROTECT:</b>	Safeguard your team against data loss

Learn more about JB&A's end-to-end media management solutions at: [jbanda.com](http://jbanda.com) - featuring CatDV

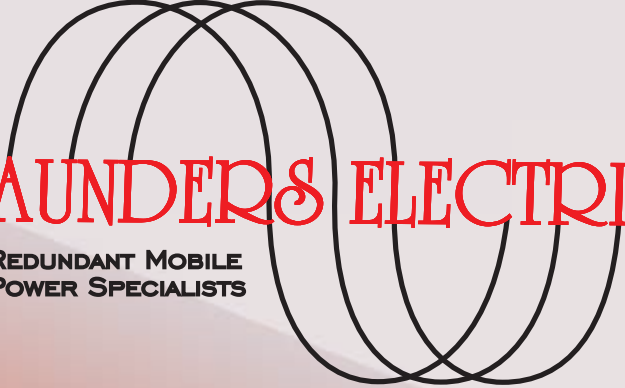

# SAUNDERS ELECTRIC

REDUNDANT MOBILE  
POWER SPECIALISTS

PROVIDING PEACE OF MIND  
*for the*  
LIVE BROADCAST INDUSTRY  
SINCE 1952

**MOBILE UPS POWER STATIONS**

**TWINPACK GENERATORS**

**TRAINED GENERATOR OPERATORS**

**TOSHIBA CERTIFIED UPS TECHNICIANS**

**SAUNDERSELECTRIC.COM**

LOS ANGELES

SAUNDERS ELECTRIC, INC  
9330 LAUREL CANYON BLVD  
ARLETA · CA · 91331  
818-771-0021

NASHVILLE

SAUNDERS ELECTRIC, LLC  
7210 HALEY INDUSTRIAL DR  
NOLENSVILLE · CA · 37135  
615-514-8140



*PDS8 Double Power Distribution Station with one of two auto-start 300KW generators*

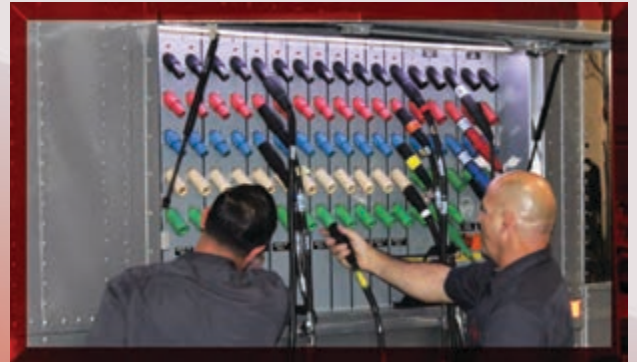

*LB-15 with interchangeable POD UPS System and auto-start 168KW generator. The POD can be exchanged for a second 168KW to create a traditional TwinPack tractor.*



*LB-13 with Twin 168KW movie quiet generators and Screens Trailer*

RECIPIENT OF A  
2016 ENGINEERING EMMY  
*for the*  
MOBILE UPS POWER STATION



# The Industry **Leader**

**in RF Video & Audio Solutions**



**CUSTOMER  
FOCUSED  
INNOVATIVE**



**RELIABLE**

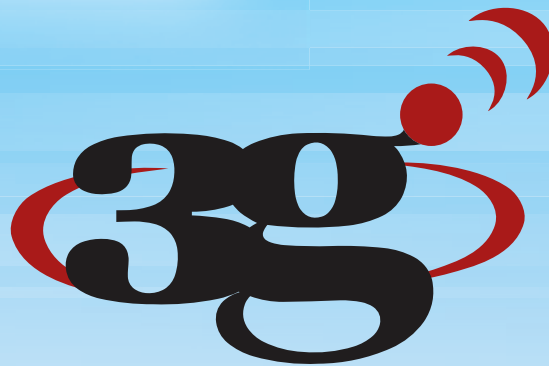

THE NEXT GENERATION OF BROADCAST TECHNOLOGY

[www.3gwireless.tv](http://www.3gwireless.tv)

410-969-3501

[info@3gwireless.tv](mailto:info@3gwireless.tv)

# Satellite Trucks

STATE	CITY	COMPANY NAME	WEBSITE	PHONE
MICHIGAN	Ann Arbor	Michigan Satellite Systems	www.misat.com	(586) 323-9590
MINNESOTA	Cottage Grove	PSB Satellite	www.PSBsatellite.com	(651) 768-9150
	Minneapolis	Arctek HD Satellite Productions	www.arcteksat.com	(612) 623-1986
	Minneapolis	RumJungle Media	www.rumjungle.com	(952) 472-5525
	St. Paul	Ingwell Communications	www.ingwellcommunications.com	(612) 839-5154
MISSOURI	St. Louis	Spot Media Transfer	www.spotmpg.com	(314) 667-5915
MONTANA	Helena	Lyon Productions	www.lyongroup.biz/content/	(406) 442-9014
NEVADA	Las Vegas	KCLV	www.kclv.tv	(702) 249-7268
	Stateline	Shoot It Live	www.shootitlive.tv	(808) 371-3023
NEW HAMPSHIRE	Pelham	Thistle Communications	www.thistlecommunications.net	(603) 598-5100
NEW JERSEY	Old Bridge	Fulton Production and Consulting	www.satellitedownlink.com	(917) 312-9894
	Wayne	Vision Quest Productions	www.visionquestproductions.com	(973) 686-9400
	Whippany	A3 Media	www.a3mediallc.com	(201) 951-0619
NEW YORK	Congers	American Satellite Uplink	www.americansatelliteuplink.com	(845) 352-0998
	Flushing	Interface Communications	www.interfacestv.com	(718) 463-8700
	Hauppauge	Miteq	www.miteq.com	(631) 439-9108
	New City	Flight 9 Satellite Services	www.flight9.com	(888) 354-4489
	New City	StreamByte TV Event Webcasting	www.streambyte.tv	(267) 382-0285
	New York	Broadcast Management Group	www.broadcastmgmt.com	(212) 784-6020
	New York	DS Simon Productions HD Television Studio	www.dssimon.com	(212) 736-2727
	New York	Metrovision Production Group	www.metrovision.tv	(212) 989-1515
	Victor	GCS	www.globalcoms.com	(585) 742-9100
	Warwick	Centrex Communications	www.centrexcom.com	(845) 987-1666
NORTH CAROLINA	West Babylon	Village Video News	www.vvn.com	(631) 752-9311
	Charlotte	Aviv Moon Productions	www.avivmoon.tv	(704) 746-3974
	Charlotte	Control 1 Communications	www.control1comm.com	(205) 706-9524
	Charlotte	Nomadic Communications	www.nomadic-comm.com	(866) 519-7723
	Charlotte	Thomas Digital	www.Thomas-Digital.com	(704) 200-9353
OHIO	Cincinnati	Central Satellite Service	www.centrsat.com	(513) 821-7200
	New Middletown	Live Mobile Group	www.livemobilegroup.com	(330) 542-0900
	Poland	First Call UPLinks	www.firstcalluplinks.com	(800) 951-6707
	Rocky River	TeleNet Media	www.telenetmedia.net	(216) 276-8841
	Sunbury	Gerling and Associates	www.gerlinggroup.com	(740) 965-2888
OKLAHOMA	Broken Arrow	Kodiak Mobile Television	www.kodiakmobile.tv	(918) 925-9877
PENNSYLVANIA	Boyerstown	J A Taylor & Associates	www.broadcastassociates.com	(610) 754-6800
	Indiana	Quintech Electronics & Communications	www.quinteelectronics.com	(800) 839-3658
	King Of Prussia	PMTV - Producers Management TeleVision	www.PMTV.com	(484) 690-9180
	Malvern	Liberty Uplink	www.libertyuplink.com	(215) 964-5222
	Philadelphia	StreamByte TV Event Webcasting	www.streambyte.tv	(267) 382-0285
	Philadelphia	Total Production Services	www.tpsweb.com	(888) 877-1178
SOUTH CAROLINA	Myrtle Beach	Satellite Papa	www.satellitepapa.com	(843) 333-5963
TENNESSEE	Cordova	ProLink Satellite	www.prolinksat.com	(901) 356-2394
	Gallatin	Brightlink HD	www.BrightlinkHD.com	(615) 289-4319
	Nashville	NorthStar Studios	www.northstarstudios.tv	(800) 605-3590
	Nashville	StagePost	www.stagepost.com	(615) 248-1978
TEXAS	Austin	ATX HD	www.atxhd.com	(800) 338-6862
	Austin	Earl Miller Productions	www.earlmillerproductions.com	(512) 458-4343
	Dallas	Texas TV Trucks	www.ifilmalliance.com/business.php?bid=1395&bttypeid=0&regionid=13	(972) 570-1118
	Denton	WSC HD Productions	www.wschdproductions.com	(940) 483-9200
	Fort Worth	Applied Telecommunications	www.appliedtelecominc.com	(817) 763-5992
	South Houston	World Teleport	www.worldteleport.org	(281) 741-8753
VIRGINIA	Falls Church	Dawnbreaker Communications	www.dawnbreakercommunications.com	(202) 288-0805
	Virginia Beach	Atlantic Satellite Corporation	www.atlanticsat.com	(757) 318-3500
	Williamsburg	Colonial Williamsburg Productions	www.history.org/productions	(757) 220-7143
WASHINGTON	Ridgefield	Wild Hare Satellite	www.wildharesat.com	(360) 573-6850
WEST VIRGINIA	Charleston	The Media Center	www.themediacenter222.com	(304) 720-5466

# AZZURRO GROUP



The Azzurro Group provides turnkey systems integration and fully managed video transport services for all Major Sports Leagues.

We are also proud to feature AzzurroCam, a customizable remote studio technology providing limitless opportunities for producing cost effective on-air content.

Call us today to learn more about Azzurro's full range of products & services.



D I G I T A L C O M M L I N K

## **DIGICASTER®**

*Revolutionizing Live Video Transport Globally*

The DIGICASTER® is an IP based low latency HD/SD broadcast quality live video transport appliance capable of delivering bidirectional H.264, MPEG4, MPEG2, MPEG1 and PAL streams, each appliance can be configured with up to 16 channels embedded audio, IP, SDI and ASI input and output. The DIGICASTER® Platform was designed to operate over Business Class Internet circuits, which significantly reduces the deployment time. Our proprietary, robust Dynamic Packet Recovery Technology is capable of withstanding more than 10 times the standard packet loss of a typical Business Class Internet circuit. Our Encoder can simultaneously broadcast, transcode and transrate an IP, SDI or ASI source for distribution to any CDN or IPTV multi-view platform. Once on the DIGICASTER® Platform, aside from interconnecting your own facilities, you also have global connectivity via numerous Satellite Teleport Facilities and Global Video Switches. All video transport on the DIGICASTER® Platform is monitored and managed 24/7/365 by our Network Operations Center.

Gone are the days of expensive point-to-point fiber circuits with long term commitments.

Who's using our technology . . .

### **iNdemand (Comcast)**

iNdemand currently accepts point-to-point fiber, satellite uplink/downlink, and IP ingest methods of content contribution for redistribution to millions of homes. Currently, the DIGICASTER® Platform is the only approved IP ingest technology accepted by iNdemand.

### **Full-Time On-Air Programming**

Newsmax, OANN (One America News Network), BlazeTV and others are currently utilizing the DIGICASTER® Platform for their primary and / or backup feeds to deliver their full-time on-air programming content to distributors such as DirecTV and Dish Network.

### **Feature Story News (FSN)**

FSN offers FSN LIVE, a growing network of live shot studios around the world with studio locations in North America, Europe, Africa, Asia and South America. The FSN LIVE network utilizes the DIGICASTER® appliances and Platform for dozens of daily video feeds across five (5) continents.

### **Broadcast Networks**

All the major Broadcast Networks receive video ingest from our DIGICASTER® Platform, whether it be via a DIGICASTER® appliance located at the ingest head-end facility, or delivered through a global video switch such as Level (3) Vyvx®. The Broadcast Networks include the likes of ABC, AP, BBC (UK), Bloomberg, CBS, CNBC, CTV (Canada), ESPN, FOX, ITV (UK), MLB, MSNBC, NBC, NFL, Network 10 (Australia), Seven Network (Australia), TSN (Canada), etc.

### **Colleges / Universities**

The DIGICASTER® Platform is currently being utilized to transmit various college sporting events to a distribution headend facility for archival and viewing live, or on demand, over the Internet.

### **Live Shot Studios**

With the DIGICASTER® Platform, global acquisition of content for tape feeds and talking head live shots has been simplified and become extremely cost effective. With a DIGICASTER® appliance and a standard Business Class Internet circuit, studios around the world are fully equipped to deliver live content globally.



## ***It's a game changer!***

skhan@dclinc.net

(954) 236-2993

# MAKE YOUR FANS FAMOUS!

Mobile Video To Broadcast. Instantly.



Contributors upload videos. Burst makes them ready for TV, the social web, and in-venue productions in near real-time.

## PLATFORM OVERVIEW

- Mobile video to broadcast, social, digital, and in-venue productions
- Simplified rights management
- UGC without an app download
- Easy to use, cloud-based CMS
- Intelligent curation tools
- Meaningful analytics

## HOW BURST IS USED

- Integrate videos from reporters & fans into live productions
- Break news first with onsite mobile production teams
- Build engagement & enhance events with crowdsourced video
- Enhance marketing with UGC
- Monetize new inventory

184 HIGH ST. BOSTON, MA 02110

[www.burst.com](http://www.burst.com)

[info@burst.com](mailto:info@burst.com)

# KMH AUDIO-VIDEO INTEGRATION

## *"BEST BY TEST!"*

The right choice to provide  
**total systems integration**  
for the sports production industry!

- Project Planning · System Design and Engineering ·
- Installation · Testing & Training ·
- Systems Maintenance & Support ·

Visit our website to view previous and upcoming projects at  
[www.kmh-integration.com](http://www.kmh-integration.com)



# DOME PRODUCTIONS



THE FUTURE ... IS NOW



**DOME** **4K**

PRODUCE IN THE HIGHEST RESOLUTION POSSIBLE

# BEHIND POWERFUL PRODUCTION



## EXPERTLY ENGINEERED SOLUTIONS FOR:

- Remote Production
- Studio Production
- Video Display
- Host Broadcasting
- Post Production & VFX
- Smart Media Asset Management & Logistics
- End-to-End OTT Solutions
- Premium Encoding Services
- CDN Federation
- Cloud Playout & MCR Services
- Broadcast IT Services

*SS-CBS is the newest addition to NEP's fleet. It features an IP-based routing system that makes it flexible, scalable, and 4K ready.*



[www.nepinc.com](http://www.nepinc.com)

# GearbaseStudy

The 11th annual SVG Gearbase Survey provides an ongoing database of production-truck technology for the North American fleet of more than 250 broadcast vehicles. The 2017 Gearbase comprises 257 total mobile units, only eight of which are SD. With SD all but dead and HD the status quo, 4K-capable trucks and units featuring IP-based infrastructure are on the rise. Of the 249 HD mobile units included in the survey, 20 are listed as 4K-capable, and 30 are 1080p-capable.

This year's Gearbase Survey drew more participating companies than ever before — 38 in all — and lists more than a dozen mobile units that debuted over the past 12 months. Here is a brief summary of the Gearbase Survey's key findings in the North American truck market. On the following pages is a listing of the trucks and specs (based on October 2016 data collected from participating companies):

- NEP has by far the largest fleet in North America with 61 trucks — boosted by several recent acquisitions. Game Creek Video and Mobile TV Group are second with 25 mobile units apiece, followed by Dome Productions (19), Lyon Video (11), F&F Productions and Gearhouse Broadcast (10 each), Live Media Group (nine), and All Mobile Video and TNDV Television (eight each). Turn to page 22 for the Total Trucks by Company graphic.
- Of the 250 trucks whose camera complement was identified by brand, 127 use Sony (51%); 74, Grass Valley (30%); 28, Ikegami (11%); and 15, Hitachi (6%).
- The battle for lens-market share remains a two-horse race. Of the 229 trucks that identified lens brand, 113 trucks carried Canon lenses exclusively in 2016 (49%), 86 have Fujinon exclusively (38%), and 26 have a mix of Canon and Fujinon lenses (11%).
- Among HD switchers, Grass Valley continues to dominate, with its units found at the center of 196 HD mobile units (76%). Sony switchers are in 29 trucks (11%), Ross Video switchers in 16 (6% each), Blackmagic Design in seven (3%), and FOR-A in three (1%).
- The video-router sector remains diverse (judging by the 195 trucks that identified router brand), led by Grass Valley in 68 trucks (35%), followed by Evertz with 47 (24%), PESA with 37 (19%), Utah Scientific with 14 (7%), Imagine Communications with 12 (6%), and Ross Video with seven (4%).
- ChyronHego is still the market leader in HD graphics, with its systems in 86% of trucks on the road (158 of the 184 trucks that specified a system). Twenty-seven trucks carry both ChyronHego and Vizrt systems, and 20 deploy Ross Video graphics (although 11 of those also use a ChyronHego system)
- In HD replay devices, EVS is once again the undisputed industry standard: 208 HD trucks rely on some form of EVS system as its primary replay device. Currently, 24 trucks carry Grass Valley K2 Dyno replay systems, although 22 of them also have EVS replay systems. Tightrope Media (four trucks), NewTek (three trucks), and Ross Video/Abekas (three trucks) also appear in the Gearbase's replay numbers for 2016.
- Calrec Audio remains the number-one audio console on HD trucks, with 151 consoles in 59% of the HD trucks. Yamaha is second, with consoles in 30 audio rooms (12%), followed by Avid/Euphonix (15 trucks), Soundcraft Expression (14), Studer (13), Lawo (nine), and Mackie (five). Allen & Heath, DiGiCo, and SSL are represented in three trucks apiece.

Visit [www.sportsvideo.org/main/gearbase](http://www.sportsvideo.org/main/gearbase)

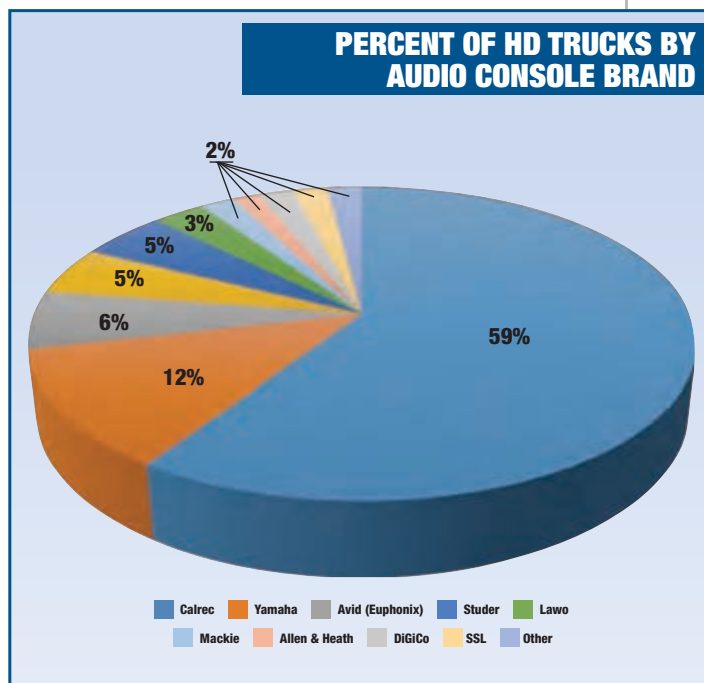
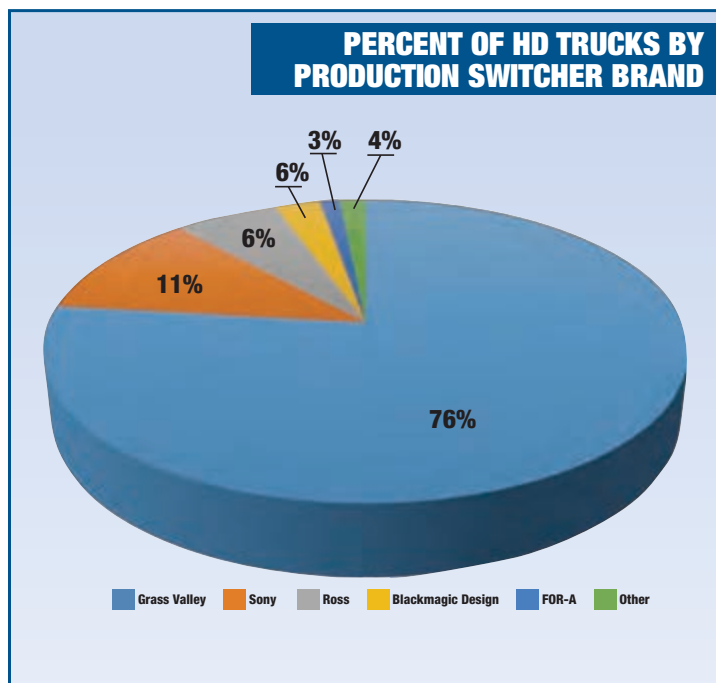

# ALWAYS EVOLVING, ALWAYS HERE



Lighter Frames

Maximized Interior Space

Highest Ceiling Heights

Lightest Weights in the Industry

Fast Set-up & Strike

Automotive Look Exterior

Opulent Interiors

COUNTLESS INNOVATIONS FOR 2017!

[www.gerlinggroup.com](http://www.gerlinggroup.com)



Gerling & Associates  
Sales Department  
[info@gerlinggroup.com](mailto:info@gerlinggroup.com)  
740-965-2888

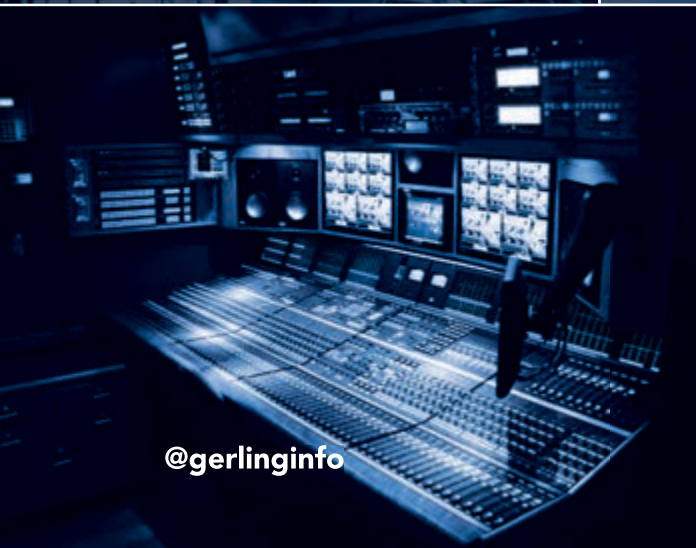

[@gerlinginfo](https://twitter.com/gerlinginfo)



[facebook.com/gerlinginfo](https://facebook.com/gerlinginfo)

# AMV



**ALL MOBILE VIDEO**

# Zurich

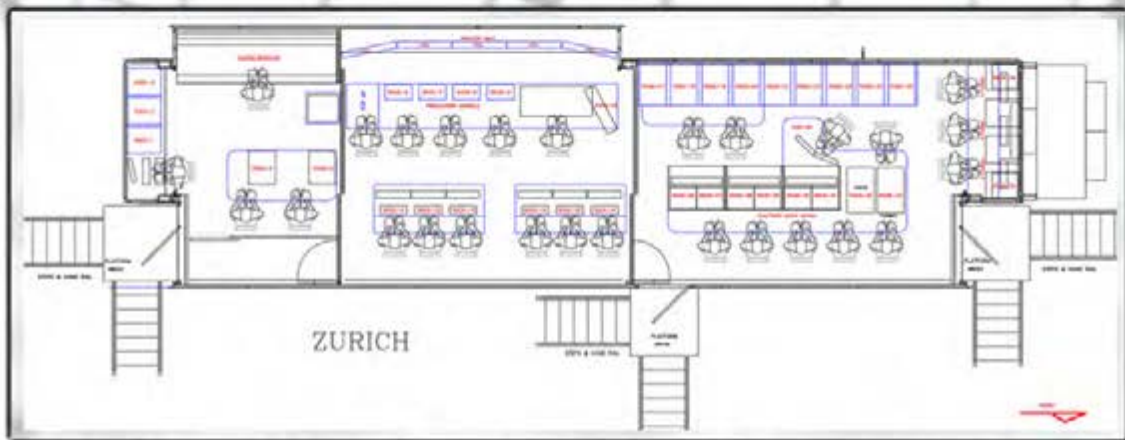

## **PROVIDING END-TO-END AUDIO/VIDEO SOLUTIONS 4K AND HDR CAPABLE**

Mobile Production Units featuring cutting edge technology and supported by the most knowledgeable engineering staff in the industry.

All Mobile Video  
221 West 26th Street  
New York, NY 10001  
Contacts:  
Eric Duke 212-727-9862  
Lenny Laxer 646-230-6996  
Tom D'Angelo 646-486-8052  
Kimberly Scholter 818-535-7506  
[www.allmobilevideo.com](http://www.allmobilevideo.com)

PROUD  
**SVG**  
SPORTS VIDEO GROUP  
**MOBILE SPONSOR**

# Token Creek

## MOBILE TELEVISION

incorporated



# SPORTS BROADCASTING

VARSITY HIRWATHA CHIPPEWA SIOUX

**HD MOBILE TELEVISION TRUCKS SERVING THE SPORTS AND  
BROADCASTING COMMUNITY SINCE 1992.**

The highest quality mobile television facilities, the finest engineering staff and the best equipment at affordable prices. Discover the extraordinary level of customer service our experienced team brings to any project, and a Midwest location for smooth, cost-conscious logistical and production planning.

VISIT  
[WWW.TOKENCREEK.COM](http://WWW.TOKENCREEK.COM)  
FOR A  
**QUICKQUOTE**

Under the bright lights  
*the world watches... we deliver*



**CSP** | **MOBILE PRODUCTIONS**

[www.cspmobile.com](http://www.cspmobile.com)  
207.282.9680

COMPANY	TRUCK NAME	DIMENSIONS/ TYPE	SD/ HD/1080P/4K- CAPABLE	TRIAx, FIBER, OR BOTH?	AUDIO CONSOLE (FADERS/CHANNELS)	# CAMERAS & MAKE	LENSES (H/HH)	GRAPHICS
<b>ADMIRAL VIDEO</b>	NLT-36	36'	HD	Both	Yamaha LS9-32	5 GV/2 Sony HD POV	4 Canon, 3 Fuji (3/4)	Ross XPression/ ChyronHego HyperX2
<b>ALL MOBILE VIDEO</b>	Epic	53' double expando	HD/HDR	Fiber	Studer Vista 62	16 Sony	16 Fujinon	Wired for 2
	Titan	60' triple expando	HD/HDR	Fiber	Studer Vista 72	24 Sony	24 Fujinon	Wired for 2
	Revolution	53' double expando	HD	Fiber	Studer Vista 62	16 Sony	16 Fujinon	Wired for 2
	Crossroads	53' triple expando	HD	Fiber	Studer Vista 62	16 Sony	16 Fujinon	Wired for 1
	Celebrity	53' triple expando	HD	Fiber	Studer Vista 62	16 Sony	16 Fujinon	Wired for 1
	NYLA	51' straight	HD	Fiber	Studer Vista 52	10 Sony	10 Fujinon	Wired for 2
	Maverick	40' expando	HD	Fiber	Studer Omega 72	10 Sony	10 Fujinon	Wired for 1
Zurich	53' double	HD/HDR	Fiber	Studer Vista 72	16 Sony	16 Fujinon	Wired for 2	
<b>BOUNCE MULTIMEDIA</b>	Unit A	53' expando	HD	Triax	Yamaha	Sony HXC100	3 Hard, 2 HH	ChyronHego Duet, Ross XPression
	Unit B	40'	SD	Triax	Yamaha	Ikegami 388W	5 70X, 2 HH	ChyronHego Duet
<b>BSI</b>	Golf 5	52'	HD RF	Fiber	N/A	24 RF camera paths	As requested	N/A
<b>CCI COMMUNICATIONS</b>	Mobile 2	36'	HD/SD	Triax	Yamaha 02R96 (24/56)	5 Sony HSC-300 wired for 8	4 Fujinon (2 23X, 2 18X), 1 Canon (2X), long available on request	ChyronHego HyperX3
<b>CLARK MEDIA</b>	Slate	40' expando	HD/1080p/4K	SMPTE fiber	Calrec Artemis Light	10 Sony 2500, 4300	Canon XJ95X8.6B, Canon HJ22X7.6, Canon HJ14X4.3B	ChyronHego Mosaic, Hyper X3
<b>CMG MOBILE PRODUCTIONS</b>	Integrity	50' expando	HD	Both	Yamaha PM5000 (56)	6 GV LDX 80 Premier	4 H/3 HH	ChyronHego HyperX3
<b>CSP MOBILE PRODUCTIONS</b>	HD1	53' expando	HD/1080p	Both	Calrec Omega	9 Ikegami wired for 12	10 Canon	ChyronHego HyperX3
	HD2	53' expando	HD/1080p	Both	Calrec Artemis	10 Ikegami wired for 16	10 Canon	ChyronHego HyperX3
	HD3	53'	HD/1080p	Both	Calrec Omega	8 Ikegami wired for 12	10 Canon	ChyronHego HyperX3
	HD4	53' expando	HD/1080p	Both	Calrec Artemis	11 Ikegami wired for 16	12 Canon	ChyronHego Mosaic
	HD-B1	53'	HD/1080p	N/A	N/A	N/A	N/A	Wired for 3 graphic units, 2 bugs units, 2 1st & Ten units
	SD5	40'	SD 16:9	Triax	Yamaha 3500 (56)	8 Ikegami	5 Canon, 5 Fujinon	ChyronHego HyperX
<b>D2 PRODUCTIONS</b>	Genesis	24'	HD	Fiber	Soundcraft GB8 (32/32)	5 Hitachi/2 POV	Fujinon, Canon (3/2)	ChyronHegoIP
	Zeppelin	40'	HD	Fiber	Soundcraft GB8 (32/32)	5 Hitachi/2 POV	Fujinon, Canon (3/2)	ChyronHego HyperX3
<b>DNA STUDIOS</b>	HDX1	53' expando	HD	Triax	Yamaha Digital 48	Sony HXC100	66X	ChyronHego Duet, Vizrt Viz
	JAGS	28'	HD	Triax	X32 Digital (40 inputs)	GV 6000 and 6200 Super Mo	55X	ChyronHego Duet, Ross XPression
	FLY1	Flypack	HD	Fiber	x32 Digital (40 inputs)	JVC GY HD	40X	Ross XPression
	REMI	Remote studio	HD/4K	Fiber	x32 Digital (40 inputs)	GV 6000	40X	Ross XPression
<b>DOME PRODUCTIONS</b>	Pioneer 4K	53' expando	HD/4K	Fiber only	Calrec Artemis Beam (360)	10 Sony 4300	12 Fujinon	ChyronHego HyperX3.0, Lyric Pro
	Journey HD	53' expando	HD	Both	Calrec Artemis Beam (360)	10 Sony 2400	12 Canon	ChyronHego HyperX3.0, Lyric Pro
	Silver HD	53' expando	HD	Both	Calrec Artemis Beam (360)	10 Sony 2400	12 Fujinon	ChyronHego HyperX3.0, Lyric Pro
	Pacific HD	53' expando	HD	Both	Calrec Artemis Beam (360)	10 Sony 2400	12 Fujinon	ChyronHego HyperX3.0, Lyric Pro
	Atlantic HD	53' expando	HD	Both	Calrec Artemis Beam (360)	10 Sony 2400	12 Fujinon	ChyronHego HyperX3.0, Lyric Pro
	Thunder HD	53' expando	HD	Both	Calrec Sigma (360)	10 Sony 1500	12 Canon	ChyronHego HyperX3.0, Lyric Pro
	Echo HD	53' expando	HD	Both	Calrec Sigma (360)	10 Sony 1500	12 Canon	ChyronHego HyperX3.0, Lyric Pro
	Sierra HD	53' expando	HD	Both	Calrec Sigma (360)	10 Sony 1500	12 Canon	ChyronHego HyperX3.0, Lyric Pro
	Spirit HD	53' expando	HD	Both	Calrec Sigma (360)	10 Sony 1500	12 Canon	ChyronHego HyperX3.0, Lyric Pro
	Trillium HD w/ B unit	53' expando	HD	Fiber only	Calrec Alpha 100 w/ Bluefin (540)	10 Sony 4300	12 Canon	ChyronHego HyperX3.0, Lyric Pro



MICROPHONES	SWITCHER, M/E	NUMBER REPLAY DEVICES	ROUTER (VIDEO/AUDIO SIZE)
Senn., Sony, A-T, E-V	Ross Carbonite, 2 M/E	1 6-ch. GV K2 Dyno, 1 3-ch. GV K2 Dyno	Ross (72x72 HD/64x64 AES, 32x32 analog)
Kits vary	Sony MVS-8000X, 5M/E	4 8-ch. EVS	PESA
Kits vary	Sony MVS-8000A, 5M/E	4 6-ch. EVS	PESA
Kits vary	Sony MVS-7000X, 5M/E	4 8-ch. EVS	PESA
Kits vary	Sony MVS-8000G, 4M/E	3 8-ch. EVS	PESA
Kits vary	Sony MVS-8000, 4M/E	2 4-ch. EVS	PESA
Kits vary	Sony MVS-8000G, 3M/E	6 Miranda HMP 1801	PESA
Kits vary	Sony MVS-6350, 3M/E	2 4-ch. EVS XT NANO	Evertz
Kits vary	Sony XVS-8000, 10M/E	4 8-ch. Sony HWS-54500 or 4-ch. link	GV
Full complement	GV Kalypso, 4M/E	2 6-ch. EVS	256x256
Full complement	GV Kalypso, 4M/E	1 6-ch. EVS	64x64
38 RF wireless	N/A	N/A	Harris 32x32
4 shotguns, 3 RE, 50 hand, 4 lavs, 4 beta, 53 headworn mics, 3 HMD 26II, 3 Daltech, more as requested	GV Karrera, 3M/E	Wired for 2 EVS. EVS XT3 7 ch, XT Access	GV Concerto with Encore (96x96 HD-SDI/32x32 AES)
6 Senn. shotguns, 6 Sony ECM-77B, 6 Shure SM58, more as requested	GV Kayenne, 4M/E	2 6-ch. EVS XT3 LSM	Imagine Platinum IP3 (288x312 3G HD-SDI, 52x30 4K/UHD)
	GV Karrera, 4M/E	2 EVS LSM, 2 DVCPRO, 1 KiPro	GV NVision 8256 PLUS (512x512/256x256)
Senn., E-V, Sony	GV 400/35 HD Kayenne, 4.5M/E	2 6-ch. EVS LSM XT2, 1 4-ch. LSM XT2, 1 4-ch. XT2 SpotBox/RO, 1 XFile3; 1 Sony 1800 HDCam; 1 Panasonic DVCPRO	Utah 400 HD (96x216 HD/80x80 AES, 40x40 analog, 128x128 MADI)
Senn., E-V, Sony	GV 400/35 HD Kayenne, 4.5M/E	2 6-ch. EVS LSM XT3, 1 4-ch. LSM XT3 SpotBox RO, 1 8-ch. XT3 RO, 1 XFile3, 4 LSM Connect Tablets; 1 Sony 1800 HDCam; 1 Panasonic DVCPRO	Utah 400 HD (528x528 HD/48x48 embedded, 384x384 MADI, 64x64 AES, 36x36 analog)
Senn., E-V, Sony	GV Kayenne 4.5M/E	2 6-ch. EVS LSM XT2, 1 4-ch. XT2 SpotBox RO, 1 XT2 XFile; 1 Sony 1800 HDCam; 1 Panasonic DVCPRO	Utah 400 HD (96x216 HD/84x84 AES, 40x40 analog, 128x128 MADI)
Senn., E-V, Sony	GV 400/35 HD Kayenne, 4.5M/E	2 6-ch. EVS HD LSM XT3, 1 4-ch. HD LSM XT3 SpotBox RO, 1 8-ch. XT3 RO, 1 XFile3, 4 LSM Connect Tablet; 1 Sony 1800 HDCam; 1 Panasonic DVCPRO	Utah 400 HD (528x528 HD/48x48 embedded, 576x576 MADI, 64x64 AES, 36x36 analog)
N/A	N/A	Wired for 4 8-ch. EVS XT3	Utah 400 HD (144x144)
Senn., E-V, Sony	GV 4000, 3M/E	4-ch. EVS XT2, 4-ch. LSM, XFile2; 2 BetaSP, 2 DigiBeta, FFV	Utah 300 (32x32 SDI video, 128x128 analog video)
Senn., E-V, Sony, Crown, Røde	NewTek TriCaster 8000, 8M/E	6-ch. NewTek 3Play, 2-ch. TriCaster DDR	Blackmagic (40x40)
Senn., E-V, Sony, Crown, Røde	Sony MVS-3000, 2M/E	2 6-ch. NewTek 3Play; 4-ch. Abekas Tria	Blackmagic (72x72)
Senn.	GV Kalypso, 4M/E	6-ch. EVS with Xfile	Evertz (96x96 HD)
Senn.	Ross Carbonite	4-ch. with 2-ch. Supermo	
Senn.	Ross Carbonite	4-ch.	
Senn.	Blackmagic ATEM 4K	4-ch.	
Senn., E-V,	GV K-Frame, 4M/E	3 EVS XT3 MAX, 1 8-ch. XT3, 4-ch. XT3 SB, XFile3, 2 XHub; HDCAM, XDCAM	Evertz (576x450/48x96)
Senn., E-V,	GV K-Frame, 4M/E	3 EVS XT3 MAX, 1 6-ch. XT3, 4-ch. XS SB, XFile 3, 2 XHub; HDCAM, XDCAM	Evertz (288x231/128x128)
Senn., E-V,	GV K-Frame, 4M/E	2 EVS XT3 MAX, 1 8-ch. XT3, 1 6-ch. XT3, 4-ch. XS SB, XFile3, 2 XHub; HDCAM, XDCAM	Evertz (282x197/128x128)
A-T, Senn., E-V, Sony	GV K-Frame, 4M/E	2 EVS XT3 MAX, 1 8-ch. XT3, 4-ch. XS SB, XFile3, 2 XHub; HDCAM, XDCAM	Evertz (282x282/128x128)
A-T, Senn., E-V, Sony	GV K-Frame, 4M/E	2 EVS XT3 MAX, 1 8-ch. XT3, 1 6-ch. XT3, 4-ch. XS SB, XFile3, 2 XHub; HDCAM, XDCAM	Evertz (282x282/128x128)
A-T, Senn., E-V, Sony	GV K-Classic, 4M/E	2 EVS XT3 MAX, 1 8-ch. XT3, 4-ch. XT2 SB, XFile 3, 2 XHub; HDCAM, XDCAM	Evertz (288x180/128x128)
A-T, Senn., E-V, Sony	GV K-Classic, 4M/E	2 EVS XT3 MAX, 1 8-ch. XT3, 4-ch. XS SB, XFile3, 2 XHub; HDCAM, XDCAM	Evertz (288x180/128x128)
A-T, Senn., E-V, Sony	GV K-Classic, 4M/E	2 EVS XT3 MAX, 1 8-ch. XT, 4-ch. XS SB, XFile3, 2 XHub; HDCAM, XDCAM	Evertz (288x180/128x128)
A-T, Senn., E-V, Sony	GV Kalypso, 4M/E	2 6-ch. EVS XT3, 1 8-ch. XT3, 1 4-ch. XS SB, XFile3, XHub; 2 HDCAM/XDCAM	GV Trinix (222x160)
A-T, Senn., E-V, Sony	GV K-Classic, 4M/E	2 6-ch. EVS XT3, 2 XT3 MAX, 4-ch. XS, XFile3, XHub3; 2 HDCAM/XDCAM	GV Trinix (256x256/256x256)

# THE POWER OF SPORTS.



## Team up with one of the industry's most reliable Global Power Providers.

Knowledge requires precise and timely information. Our broadcast compound **Portable Command Center** seamlessly communicates with our first in the industry **Uninterruptible Power Supplies**, generators, and distribution modules, all of which incorporate smart technologies. Critical assets in the compound, including venue power distro and broadcast trucks, continuously provide data to the Command Center.

Cat Entertainment Services system analytics anticipate issues before they become problems allowing for immediate response. Our industry leading 'know-how' is the combination of our experience, expertise and sophisticated integration of technologies. We provide a high return on your investment without putting your valuable reputation at risk. Let Cat Entertainment Services engineer your next solution.



**GENERATORS, UPS, POWER DISTRIBUTION & FACTORY-TRAINED TECHNICIANS**

LOS ANGELES | NEW YORK | DALLAS | ORLANDO  
NEW ENGLAND | ATLANTA | BATON ROUGE | CHARLOTTE

**866.ROCK.CAT**  
7 6 2 5 2 2 8

[es-cat.com](http://es-cat.com)

**Entertainment  
Services**

**CAT**<sup>®</sup>  
Rental Power



# YES PRODUCTIONS

A FULL SERVICE PRODUCTION COMPANY

FEATURING:

80' x 50' Sound Stage ■ Final Cut Pro Suites ■ XD Cam Field Production

2 53' HIGH DEFINITION PRODUCTION TRUCKS EQUIPPED WITH:

Calrec Audio Consoles ■ Ikegami Cameras ■ Fujinon Lenses ■ Multiple EVS Units  
x File ■ HD CAM VTRs ■ GVG K-Frame & Kalypso Switchers ■ Duet Graphics

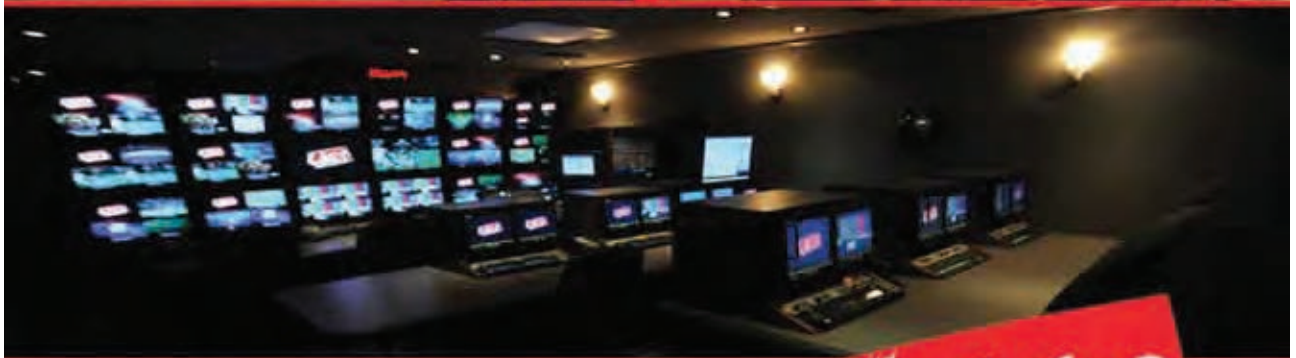

[WWW.YESPRODUCTIONS.COM](http://WWW.YESPRODUCTIONS.COM)

CONTACT JIM MORIARTY

800.736.8812

504.616.3999 (CELL)

[JIM@YESPRODUCTIONS.COM](mailto:JIM@YESPRODUCTIONS.COM)



COMPANY	TRUCK NAME	DIMENSIONS/ TYPE	SD/HD/1080P/ 4K-CAPABLE	TRIAx, FIBER, OR BOTH?	AUDIO CONSOLE (FADERS/CHANNELS)	# CAMERAS & MAKE	LENSES (H/HH)	GRAPHICS
DOME PRODUCTIONS	Trillium 4K B unit		4K					
	Horizon HD	53' expando	HD	Triax	Calrec Alpha 100 (360)	10 Sony HSC-300	12 Canon	ChyronHego HyperX3.0, Lyric Pro
	Majestic HD	53' expando	HD	Triax	Calrec Alpha 100 (360)	10 Sony HSC-300R	12 Canon	ChyronHego HyperX3.0, Lyric Pro
	Tribute HD	53' expando	HD	Triax	Calrec Omega (240)	10 Sony 2400	12 Canon	ChyronHego HyperX3.0, Lyric Pro
	National HD	53' expando	HD	Both	SSL C-100	9 Sony 1500	11 Canon	ChyronHego HyperX3.0, Lyric Pro
	Hudson HD	53' expando	HD	Both	SSL C-100	9 Sony 1500	11 Canon	ChyronHego HyperX3.0, Lyric Pro
	Kodiak HD	40'	HD	Triax	Calrec S2	7 GV LDK-6000	7 Canon	ChyronHego HyperX3.0, Lyric Pro
	Sidecar HD	16' trailer	HD	Upon request	Mackie 1402	As requested	As requested	As requested
	Beacon (uplink)	30' non exp	HD	Fiber	Yamaha MB02R96	5 Sony 1500	5 Canon	As requested
	Rico (uplink)	tractor cabin	HD	N/A	None	None	None	None
	Upstream (uplink)	tractor cabin	HD	N/A	None	None	None	None
	Stargazer (uplink)	tractor cabin	HD	N/A	None	None	None	None
Unite HD	53' double expando	HD	As requested	As requested	As requested	As requested	As requested	
ENCOMPASS DIGITAL MEDIA	TES45	34'; C- or Ku-band	HD	Fiber	PreSonus StudioLive 24.4.2	4 Panasonic HDX-900	Fujinon HA18X7.6	Ross XPression
	TES5	32'; Ku-band	HD	SMPTE/TAC fiber	Mackie 1604VLZ	Wired for 5 Panasonic HC-3800	Fujinon XA20X8.5 BERM	N/A
F&F PRODUCTIONS	GTX-7	53' expando	HD	Both	Calrec Artemis Light w/ Bluefin2 (340)	8 Sony 1500	6 Fujinon 88X, 4 Fujinon 22X, 2 Fujinon 12X4.5	ChyronHego HyperX3
	GTX-8	53' expando	HD	Both	Calrec Sigma w/ Bluefin	12 Sony 1500	2 Fujinon 101X, 4 Fujinon 88X, 4 Fujinon 22X, 4 Fujinon 12X4.5	ChyronHego HyperX3
	GTX-9	53' expando	HD	Both	Calrec Sigma w/ Bluefin	9 Sony 1500	6 Fujinon 88X, 4 Fujinon 22X, 4 Fujinon 12X4.5	ChyronHego HyperX3
	GTX-10	53' expando	HD	Both	Calrec Artemis Beam w/ Bluefin2 (340)	8 Sony 2400	6 Fujinon 88X, 4 Fujinon 22X, 4 Fujinon 12X4.5	ChyronHego HyperX3
	GTX-11	53' expando	HD	Both	Calrec Artemis Beam w/ Bluefin2 (340)	14 Ikegami	4 Fujinon 101X, 3 Fujinon 87X, 5 Fujinon 22X, 2 Fujinon 12X4.5	ChyronHego HyperX3
	GTX-12	53' expando	HD	Both	Calrec Artemis Beam w/ Bluefin2 (340)	14 Ikegami	4 Fujinon 101X, 3 Fujinon 87X, 5 Fujinon 22X, 2 Fujinon 12X4.5	ChyronHego HyperX3
	GTX-14	53' expando	HD	Both	Calrec Artemis Beam w/ Bluefin2 (340)	14 Ikegami	3 Fujinon 101X, 4 Fujinon 87X, 5 Fujinon 22X, 2 Fujinon 12X4.5	ChyronHego HyperX3
	GTX-15	53' double expando	HD	Both	Calrec Alpha w/ Bluefin2 (480)	14 Ikegami	5 Fujinon 101X, 2 Fujinon 87X, 5 Fujinon 22X, 2 Fujinon 12X4.5	ChyronHego HyperX3
	GTX-16	53' double expando	HD/1080p	Both	Calrec Artemis Beam w/ Bluefin2 (340)	14 Ikegami	4 Fujinon 101X, 3 Fujinon 88X, 4 Fujinon 22X, 3 Fujinon 12X4.5	ChyronHego HyperX3
	GTX-17	53' double expando	HD/1080p	Both	Calrec Apollo w/ Bluefin2 (1,020)	14 Sony HDC-2500	8 Fujinon 88X, 4 Fujinon 23X, 3 Fujinon 16X4.5	ChyronHego HyperX3
GAME CREEK VIDEO	94	53' expando	HD/1080p	Both	Calrec Artemis (144/1,020)	10 Sony HDC-2500	5 Canon DigiSuper 76X, 1 Canon DigiSuper 100X, 3 Canon 22X7.8 ENG, 2 Canon 14X4.3 ENG	ChyronHego Mosaic
	Amazin'	53' expando	HD/1080p	Both	Calrec Artemis (144/1,020)	10 Sony HDC-2500	6 Canon DigiSuper 95X 9.3, 2 Canon DigiSuper 100X 9.3, 3 Canon 22X 7.8 ENG, 2 Canon 14X4.3 ENG	ChyronHego Mosaic
	Apollo	53' expando	HD/1080p	Both	Calrec Artemis (144/1,020)	10 Sony HDC-2500	5 Canon DigiSuper 76X 9.3, 1 Canon DigiSuper 100X 9.3, 3 Canon 22X 7.8 ENG, 2 Canon 14X4.3 ENG	ChyronHego Mosaic
	Maverick	53' expando	HD/1080p	Both	Calrec Artemis (144/1,020)	12 Sony HDC-2500	7 Canon DigiSuper 72X9.3, 2 Canon 11X4.7B ENG	ChyronHego Mosaic

MICROPHONES	SWITCHER, M/E	NUMBER REPLAY DEVICES	ROUTER (VIDEO/AUDIO SIZE)
	GV K-Frame, 4M/E	As requested 6 frames of 4K service based on 2 in/2 out per frame	GV Trinx (512x512/128x128)
A-T, Senn., E-V, Sony	GV Kalypso, 4M/E	3 6-ch. EVS XT2+, 1 XT2 4-ch. SB, XFile3, XHub; 2 HDCAM/XDCAM	GV Trinx (224x320/96x64)
A-T, Senn., E-V, Sony	GV Kalypso, 4M/E	2 6-ch. EVS XT3, 1 6-ch. XT2+, 4-ch. XT2 SB, XFile3, 1 XHub3; HDCAM/XDCAM	GV Trinx (224x320/96x64)
A-T, Senn., E-V, Sony	GV K-Classic, 4M/E	2 6-ch. EVS XT3, 1 4-ch. XT3, 4-ch. XS SB, XFile3, XHub; 2 HDCAM/XDCAM	Harris (64x64/128x128)
A-T, Senn., E-V, Sony	GV Kalypso, 4M/E	3 6-ch. EVS XT2, 4-ch. XS SB, XFile2D, XHub; 2 HDCAM/XDCAM	GV Trinx (256x256/256x256)
A-T, Senn., E-V, Sony	GV Kalypso, 4M/E	3 6-ch/ EVS XT2, 4-ch. XS SB, XFile2D, XHub; 2 HDCAM/XDCAM	GV Trinx (256x256/256x256)
A-T, Senn., E-V, Sony	GV Karrera, 2.5M/E	2 6-ch. EVS XT2, 1 2-ch. XS SB, XFile2, XHub2; HDCAM/XDCAM	Harris (32x32/32x32)
None	FOR-A HVS-300HS	As requested	
A-T, Senn., E-V, Sony	FOR-A HVS-300HS	Ku-band uplink with redundant-path ETM HPAs (400 W), Adtec/Ericsson, 2.4-m AVL dish	Leitch (16x16), Kramer (16x16)
None	None	Ku-band uplink with redundant-path CPI HPAs (400 W), Adtec encoders, 1.8-m GD Vertex dish	None
None	None	Ku-band uplink with redundant-path MCL HPAs (400 W), Ericsson encoders, 1.8-m GD Vertex dish	None
None	None	Ku-band uplink with redundant-path MCL HPAs (400 W), Ericsson encoders, 1.8-m GD Vertex dish	None
As requested	As requested	Integrated with a router and intercom system and ready to deploy for multipurpose function as a host facility	Available
N/A	Ross Crossover Solo	1 AJA KiPro Rec/Play; additional available	Blackmagic (40x40 SDI embedded audio only)
N/A	PanasonicHS-410n	1 AJA KiPro Rec/Play; additional available	Blackmagic (40x40 SDI embedded audio only)
A-T, E-V, Senn., Shure, Sony	GV Kalypso, 4M/E	2 6-ch. EVS XT2+, 2 4-ch. RO XT2+, 1 4-ch. SpotBox, XFile2, 1 XHub2; 2 Sony DW-A500, 1 DVCPRO 1700, 1 HDCam 1800	PESA HD multirate video (144x352), PESA DRS audio (128x128 analog, 128x128 AES, 128x128 MADI, 256x256 embedded)
A-T, E-V, Senn., Shure, Sony	GV Kayenne, 4.5M/E, K2 Solo, GV Kayenne Image Store	3 6-ch. EVS XT2, 2 4-ch. XT2, 2 4-ch. RO XT2, 1 4-ch. SpotBox, XFile2, 2 XHub2, IPDirector, XTAcess; 2 Sony M2000, 2 DVCPRO 1700, 1 DVCPRO 1400, 1 HDCam 1800	PESA HD multirate video (192x448), PESA DRS audio (512x512 analog, 512x512 AES, 128x128 MADI)
A-T, E-V, Senn., Shure, Sony	GV Kayenne, 4.5M/E, K2 Solo, GV Kayenne Image Store	2 6-ch. EVS XT2, 2 4-ch. RO XT2, 1 4-ch. SpotBox, XFile2, 2 XHub2; 2 Sony M2000, 1 DVCPRO 1700, 1 DVCPRO 1400, 1 HDCam 1800	PESA HD Multirate video (208x464), PESA DRS audio (256x256 analog, 256x256 AES, 128x128 MADI, 128x128 embedded)
A-T, E-V, Senn., Shure, Sony	GV Kayenne, 4.5M/E; K2 Solo, GV Kayenne Image Store	2 6-ch. EVS XT2+, 2 4-ch. RO XT2+, 1 4-ch. SpotBox, XFile2+, 2 XHub2; 1 Sony M2000, 1 DVCPRO 1700, 1 DVCPRO 1400, 1 HDCam 1800	PESA HD multirate video (192x416), PESA DRS audio (256x256 analog, 256x256 AES, 128x128 MADI, 256x256 embedded)
Senn., E-V, Sony	GV Kayenne, 4.5M/E; GV Kayenne Image Store	4 8-ch. EVS XT3, 1 4-ch. XT2 SpotBox, 1 XFile, 2 XHub; 1 DVCPRO, 1 DigiBeta	GV Trinx (256x256 HD/SD)
Senn., E-V, Sony	GV Kayenne; K-Frame, 6M/E; GV Kayenne Image Store	2 6-ch. EVS XT2, 2 4-ch. HD XT2, 1 XFile2, 1 4-ch. XT2 SpotBox; 1 DVCPRO, 1 DigiBeta	GV Trinx (256x256 HD/SD)
Senn., E-V, Sony	GV Kayenne; K-Frame 6M/E; GV Kayenne, Image Store, 4-ch K2 Summit	4 6-ch. EVS XT2, 1 XT2, 4-ch. SpotBox, 1 XFile2; 2 DVCPRO; DigiBeta	GV Trinx (256x256 HD/SD)
Senn., E-V, Sony	GV Kayenne; K-Frame, 9M/E; GV Kayenne Image Store	4 6-ch. EVS XT2+, 1 4-ch. XT2+ SpotBox; 2 DVCPRO; 1 HDW-2000	NVision (288x576 HD/SD) expandable
Senn., E-V, Sony	GV Kayenne K-Frame, 9M/E; GV Kayenne Image Store	4 8-ch. EVS HD XT3, 1 6-ch. XT3 SpotBox, 2 XFiles; 1 IPDirector; 2 XHub; 2 SRW5500, 1 DVCPRO; 10 G Network	Evertz (288x516 HD)
Senn., E-V, Sony	GV Kayenne K-Frame, 9M/E; GV Kayenne Image Store	4 8-ch. EVS HD XT3, 1 6-ch. XT3 SpotBox, 2 Xfiles, 1 IPDirector, 2 XHubs; 2 SRW5500, 1 DVCPRO	Evertz (496x962 HD)
8 Senn. HMD 26 headsets, 8 Daltech announce/cough boxes, 12 Senn. MD-46 HH, 6 Senn. MKH-8070 long shotgun, 6 Senn. MKH-416 short shotgun, 2 Senn. MKH 418 stereo shotgun, 4 A-T AT4027 stereo shotgun, 6 E-V RE50 HH, 12 Sony ECM 77 lav	GV Kayenne K-Frame, 3M/E	3 6-ch. EVS XT3 LSM, 2 4-ch. XT3 RO, 1 4-ch. XT3 SpotBox, 1 XFile3; 1 Sony DWV A500 DigiBeta, 1 HDW-D1800 HDCam, 1 XDS-PD2000 XDCam; 4 DVD/VHS recorders	Evertz EQX HD video (396x684), Evertz EMX audio (384x384 AES, 256x256 MADI, 288x288 analog, 128x128x16 HD-SDI embedded)
8 Senn. HMD 26 headset, 8 Daltech announce/cough box, 12 Senn. MD-46 HH, 6 Senn. MKH-8070 long shotgun, 6 Senn. MKH-416 short shotgun, 2 Senn. MKH 418 stereo shotgun, 4 A-T AT4027 stereo shotgun, 6 E-V RE50 HH, 12 Sony ECM 77 lav	GV Kayenne K-Frame, 4.5M/E	3 6-ch. EVS XT3 LSM, 2 4-ch. XT3 RO, 1 4-ch. XT3 SpotBox, 1 XFile3; 1 Sony DWV A500 DigiBeta, 1 HDW-D1800 HDCam, 1 XDS-PD2000 XDCam; 2 Mac Minis, 4 DVD/VHS recorders	Evertz EQX HD video (396x684), Evertz EMX audio (384x384 AES, 256x256 MADI, 288x288 analog, 128x128x16 HD-SDI embedded)
8 Senn. HMD 26 headset, 8 Daltech announce/cough box, 6 Beyer M58 HH, 12 Senn. MD-46 HH, 6 Beyer MC836 short shotgun, 6 Beyer MC837 long shotgun, 6 Senn. MKH 416 shotgun, 6 E-V 635A HH, 6 Sony ECM 66 lav, 5 Sony ECM 77 lav	GV Kayenne, 3M/E	3 6-ch. EVS XT3 LSM, 2 4-ch. XT3 RO, 1 4-ch. XT3 SpotBox, 1 XFile3; 1 Sony DWV A500 DigiBeta VTR, 1 HDW-D1800 HDCam, 1 XDS-PD2000 XDCam; 4 DVD/VHS recorders	Evertz EQX HD video (396x684), Evertz EMX audio (384x384 AES, 256x256 MADI, 288x288 analog, 128x128x16 HD-SDI embedded)
8 Senn. HMD 25 headsets, 8 Daltech talkback/cough box, 6 Beyer M58 HH, 12 Senn. MD-46 HH, 6 Beyer MC836 short shotgun, 6 Beyer MC837 long shotgun, 6 Senn. MKH 416 shotgun, 6 E-V 635A HH, 6 Sony ECM 66 lav, 6 Sony ECM 77 lavalier	GV Kayenne K-Frame, 4.5M/E	3 12-ch. EVS XT3 LSM, 1 4-ch. XT3 SpotBox, 1 XFile3; 1 Panasonic DVCPRO AJ-HD1700; 4 DVD/VHS recorders	Evertz EQX HD video (396x684), Evertz EMX audio (384x384 AES, 256x256 MADI, 288x288 analog, 128x128x16 HD-SDI embedded)



# GREAT PARTNERS GREAT FACILITIES

Let Alliance Productions be your source for quality mobile units from coast to coast. We have 15 years experience matching the right mobile units to client needs. The partners in Alliance strive to make every show a resounding success. From live sports to entertainment to corporate or news events, Alliance Productions will deliver for you.



  
**Alliance**

501.219.2653

[www.allianceproductions.com](http://www.allianceproductions.com)



Flare 4K  
1080/60p



RCP

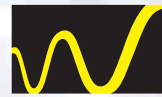

Wave  
Central

AXIS Pico 3G  
Wireless Video



FREEFLY

MAVI MO

Handheld Camera Stabilizer



**SHURE**  
**AXIENT**

Advanced Wireless  
Microphone Technology



FreeSpeak II  
Wireless Intercom



Fiber CWDM Mux  
& 3G Transport



Full Service Rentals  
Sales  
Consulting  
Integration



CP Communications

cpcomms.com  
800-762-4254  
sales@cpcomms.com

COMPANY	TRUCK NAME	DIMENSIONS/ TYPE	SD/HD/1080P/ 4K-CAPABLE	TRIAx, FIBER, OR BOTH?	AUDIO CONSOLE (FADERS/CHANNELS)	# CAMERAS & MAKE	LENSES (H/HH)	GRAPHICS
GAME CREEK VIDEO	Dynasty	53' expando	HD/1080p	Both	Calrec Alpha w/ Bluefin (96/512)	12 Sony HDC-1500	2 Canon DigiSuper 100X9.3, 4 Canon DigiSuper 86X9.3, 3 Canon DigiSuper 75X9.3, 3 Canon 22X7.8 ENG, 1 Canon 11X4.7 ENG	ChyronHego Mosaic
	Freedom	53' expando	HD/SD	Both	Calrec Alpha w/ Bluefin (96/512)	10 Sony HDC-1500	4 Canon DigiSuper 75X9.3, 2 Canon DigiSuper 86X9.3, 1 Canon DigiSuper 100X9.3, 4 Canon 21X7.8 ENG, 1 Canon 11X4.7B ENG, 1 Canon 21AX7.8	ChyronHego Mosaic
	FX	2x 53' expando	HD/1080p	Both	Calrec Bluefin Alpha (96/162)	14 Sony HDC-1500	12 Canon DigiSuper 100X9.5, 4 Canon 21X7.8 ENG, 2 Canon 11X4.7B ENG	ChyronHego Mosaic
	Gemini	44' dual expando	HD/1080p	Both	Calrec Omega (64/160)	6 Sony HDC-1500	4 Canon DigiSuper 72X9.3, 2 Canon 22X7.8 ENG, 1 Canon 14X4.3 ENG	ChyronHego Mosaic
	Discovery	44' dual expando	HD/1080p	Both	Calrec Artemis (144/1,020)	6 Sony HDC-1500	4 Canon DigiSuper 72X9.3, 2 Canon 22X7.8 ENG, 1 Canon 14X4.3 ENG	ChyronHego Mosaic
	Pride	53' expando	HD/1080p	Both	Calrec Apollo w/ Bluefin (144/1,020)	10 Sony HDC-2500	2 Canon DigiSuper 100X9.3 Lenses, 5 Canon DigiSuper 75X9.3, 4 Canon 22X7.8 ENG, 2 Canon 14X4.7 ENG	ChyronHego Mosaic
	RiverHawk	53' expando	HD/1080p/4K	Both	Calrec Artemis (144/1,020)	12 Sony HDC-4300	8 Canon DigiSuper 95X8.6, 2 Canon 22X7.8 ENG, 2 Canon HJ17eX6.2B IRSE, 2 Canon 14X4.3 ENG	ChyronHego Mosaic
	Glory	53' expando	HD/1080p	Both	Calrec Apollo w/ Bluefin (144/1,020)	14 Sony HDC-2500	5 Canon DigiSuper 100X9.3, 3 Canon DigiSuper 86X9.3, 2 Canon DigiSuper 75X9.3, 2 Canon 22X7.8 ENG, 2 Canon 14X4.7 ENG	ChyronHego Mosaic
	Justice	53' expando	HD/1080p	Both	Calrec Apollo (144/1,020)	10 Sony HDC-1500R	1 Canon DigiSuper 100X9.3, 1 Canon DigiSuper 86X9.3, 3 Canon DigiSuper 75X9.3, 2 Canon 22X7.8 ENG, 2 Canon 14X4.3 ENG	ChyronHego Mosaic
	Larkspur	53' expando	HD/1080p	Both	Calrec Alpha w/ Bluefin (80/320)	10 Sony HDC-1500R	1 Canon DigiSuper 100X9.3, 4 Canon DigiSuper 75X9.3, 4 Canon 22X7.8 ENG, 2 Canon 14X4.3 ENG	ChyronHego Mosaic
	Legends	53' expando	HD/SD	Both	Calrec Alpha w/ Bluefin (80/320)	10 Sony HDC-1500R	1 Canon DigiSuper 86X9.3, 5 Canon DigiSuper 75X9.3, 3 Canon 22X7.8 ENG, 2 Canon 14X4.3 ENG	ChyronHego Mosaic
	Liberty	53' expando	HD/SD	Both	Calrec Alpha w/ Bluefin (80/320)	12 Sony HDC-1500R	2 Canon DigiSuper 100X9.3, 4 Canon DigiSuper 86X9.3, 2 Canon DigiSuper 75X9.3, 2 Canon 22X7.8 ENG, 2 Canon 11X4.7B ENG	ChyronHego Mosaic
	Northstar	53' expando	HD/SD	Both	Calrec Alpha w/ Bluefin (64/320)	10 Sony HDC-1500R	6 Canon DigiSuper 75X9.3, 3 Canon 22X7.8 ENG, 2 Canon 11X4.7B ENG	ChyronHego Mosaic
	Patriot	53' expando	HD/SD	Both	Calrec Alpha (96/108 stereo, 104 mono, 52 surround)	12 Sony HDC-1500R	2 Canon DigiSuper 86X9.3, 5 Canon DigiSuper 75X9.3, 4 Canon 21X7.8 ENG, 1 Canon 11X4.7B ENG	ChyronHego Mosaic
	Spirit	53' expando	HD/1080p	Both	Calrec Apollo w/ Bluefin (144/1,020)	12 Sony HDC-2500	2 Canon DigiSuper 100X9.3, 6 Canon DigiSuper 95X8.6, 3 Canon 22X7.8 ENG, 4 Canon 14X4.3 ENG	ChyronHego Mosaic
Victory	53' expando	HD/1080p	Both	Calrec Apollo w/ Bluefin (144/1,020)	12 Sony HDC-2500	2 Canon DigiSuper 100X9.3, 5 Canon DigiSuper 86X9.3, 3 Canon 22X7.8 ENG, 2 Canon 14X4.7 ENG	ChyronHego Mosaic	



MICROPHONES	SWITCHER, M/E	NUMBER REPLAY DEVICES	ROUTER (VIDEO/AUDIO SIZE)
8 Senn. HMD 25 headset, 8 Studio Technologies 210 Talkback/cough box, 6 Beyer M58 HH, 12 Senn. MD-46 HH, 6 Beyer MC836 short shotgun, 6 Beyer MC837 long shotgun, 6 Senn. MKH 416 shotgun, 6 E-V 635A HH, 6 Sony ECM 66 lav, 6 Sony ECM 77 lav	GV K-Frame, 4.5M/E	2 6-ch. EVS XT2+ LSM, 4 4-ch. XT2+ R0, 1 4-ch. XT2+ SpotBox, 1 XT2+ XFile; 1 Sony DWW A500 DigiBeta VTR, 1 M2000 HDCAM VTR; 4 DVD/VHS recorders	Evertz multiformat (576x1152 video), Evertz (1024x1024 audio)
8 Senn. HMD 25 headset, 8 Studio Technologies 210 talkback/cough box, 6 Beyer M58 HH, 12 Senn. MD-46 HH, 6 Beyer MC836 short shotgun, 6 Beyer MC837 long shotgun, 6 Senn. MKH 416 shotgun, 6 E-V 635A HH, 6 Sony ECM 66 lav, 6 Sony ECM 77 lav	GV Kayenne, 3M/E	2 6-ch. EVS XT2 LSM, 3 4-ch. XT2 R0, 1 SpotBox, 1 XFile; 1 Sony DWW A500 DigiBeta VTR; 1 Panasonic AJ HD 1700A DVCPRO VTR; 4 DVD recorders	Evertz EQX HD video (288x288 + 288 XLink), GV NVision mono audio (512x512 AES and analog)
8 Senn. 416, 4 Senn. ME-66, 4 Senn. ME-67, 8 Audix D-3.4 Senn. MKH-70, 18 A-T 815-ST, 6 Senn. MD-46, 8 Shure VP-88, 10 Senn. E-825, 8 A-T 825	GV Kayenne K-Frame, 4.5M/E	2 6-ch. EVS HD XT2 LSM, 4 6-ch. XT2, 4 6-ch. XT2 R0, 1 6-ch. XT2 SpotBox, 2 XFile, 1 IPDirector; 1 Sony DWW A500 DigiBeta VTR; 1 Panasonic AJ HD 1800A DVCPRO VTR, 1 D-5 VTR; 4 DVD/VHS recorders	PESA HD video (512x1024), PESA DRS mono audio (2048x2048 AES and analog)
6 Senn. HMD 25 headset, 6 Daltech announce/cough box, 4 Beyer M58 HH, 4 Senn. MD-46 HH, 7 Beyer MC836 short shotgun, 6 Beyer MC837 long shotgun, 4 Senn. MKH 416 shotgun, 5 E-V 635A HH, 1 Shure SM58 HH, 6 Sony ECM 66 lav, 6 Sony ECM 77 lav	GV Kayenne, 3M/E	1 6-ch. EVS XT2+ LSM, 2 4-ch. XT2+ R0, 1 4-ch. XT2+ SpotBox, 1 XFile; 2 Sony DWW A500 DigiBeta VTR; 4 DVD/VHS recorders	Evertz EQX HD video (288x288), Evertz EMX audio (384x384 AES, 1024x1024, MADI, 192x192 analog, 128x128x16 HD-SDI embedded), Evertz 72-Button Multicolor Panels, Evertz 40-Button Multicolor Panels
6 Senn. HMD 25 headset, 6 Daltech announce/cough box, 4 Beyer M58 HH, 4 Senn. MD-46 HH, 7 Beyer MC836 short shotgun, 6 Beyer MC837 long shotgun, 4 Senn. MKH 416 shotgun, 5 E-V 635A HH, 1 Shure SM58 HH, 6 Sony ECM 66 lav, 6 Sony ECM 77 lav	GV K-Frame, 4.5M/E	1 6-ch. EVS XT2+ LSM; 2 4-ch. XT2+ R0; 1 4-ch. XT2+ SpotBox, 1 XFile; 2 Sony DWW A500 DigiBeta VTR; 4 DVD/VHS recorders	Evertz EQX HD video (288x288), Evertz EMX audio (384x384 AES, 1024x1024 MADI, 192x192 analog, 128x128x16 HD-SDI embedded)
8 Senn. HMD 26 headset, 8 Studio Technologies 210 talkback/cough box, 12 Senn. MD-46 HH, 6 Senn. MKH 416 shotgun, 2 Senn. MKH 418S stereo shotgun, 6 Senn. 8070 shotgun, 4 A-T BP4027 long stereo shotgun, 6 E-V RE50 HH, 6 Sony ECM 77	GV K-Frame, 4.5M/E	2 6-ch. EVS XT2+ LSM, 1 4-ch. XT2+ R0, 1 4-ch. XT2+ SpotBox, 1 XT2+ XFile; 1 Sony DWW A500 DigiBeta VTR; 1 Panasonic DVCPRO AJ-HD1700; 4 DVD/VHS recorders	576x1152 multiformat video router with 128x128 embedded mux/demux capability, 192x192 AES audio (384x384 mono ch.), 288x288 analog audio, 16x16 MADI (1024x1024 mono ch.), 128x128 video I/O with 16 ch. of embedded audio each (2048x2048)
8 Senn. HMD 26 headset, 8 Daltech announce/cough box, 12 Senn. MD-46 HH, 6 Senn. MKH 416 shotgun, 2 Senn. MKH 418S stereo shotgun, 6 Senn. 8070 shotgun, 4 A-T BP4027 long stereo shotgun, 6 E-V RE50 HH, 12 Sony ECM 77 lav	GV Kayenne K-Frame, 4M/E	4 8-ch. EVS XT3 LSM, 5 EVS 4-ch. XT2+ R0 VTR Emulators, 1 4-ch. XT2+ SpotBox, 1 XT2+ XFile; 1 Sony DWW A500 DigiBeta VTR; 1 Panasonic DVCPRO AJ-HD1700; 4 DVD/VHS recorders	576x1152 multiformat video with 128x128 embedded mux/demux capability, 192x192 AES audio (384x384 mono ch.), 288x288 analog audio, 16x16 MADI (1024x1024 mono ch.), 128x128 video I/O with 16 channels of embedded audio each (2048x2048)
8 Senn. HMD 26 headset, 8 Studio Technologies 210 talkback/cough box, 12 Senn. MD-46 HH, 6 Senn. MKH 416 shotgun, 6 Senn. MKH 418S stereo shotgun, 6 Senn. 8070 shotgun, 4 A-T BP4027 long stereo shotgun, 6 E-V RE50 HH, 6 Sony ECM 77 lav	GV Kayenne K-Frame, 4.5M/E	4 6-ch. EVS XT2+ LSM, 5 4-ch. XT2+ R0 VTR Emulators, 1 4-ch. XT2+ SpotBox, 1 XT2+ XFile; 1 Sony DWW A500 DigiBeta VTR; 1 Panasonic DVCPRO AJ-HD1700; 4 DVD/VHS recorders	576x1152 multiformat video with 128x128 embedded mux/demux capability, 192x192 AES audio (384x384 mono ch.), 288x288 analog audio, 16x16 MADI (1024x1024 mono ch.), 128x128 video I/O with 16 ch. f embedded audio each
8 Senn. HMD 25 headset, 8 Daltech announce/cough box, 6 Beyer M58 HH, 12 Senn. MD-46 HH, Beyer MC836 short shotgun, 6 Beyer MC837 long shotgun, 6 Senn. MKH 416 shotgun, 6 E-V 635A HH, 6 Sony ECM 66 lav, 6 Sony ECM 77 lav	GV Kayenne, 3M/E	2 6-ch. EVS XT2+ LSM, 2 6-ch. XT2+ R0 VTR Emulators, 2 4-ch. XT2+ R0 VTR Emulators, 1 4-ch. XT2+ SpotBox, 1 XFile; 2 Sony DWW A500 DigiBeta VTR; 2 Panasonic AJHD1800P DvcPRO; 4 DVD/VHS recorders	Evertz EQX HD video (396x684), Evertz EMX audio (384x384 AES, 256x256 MADI, 288x288 analog, 128x128x16 HD-SDI embedded)
8 Senn. HMD 25 headset, 8 Daltech announce/cough box, 6 Beyer M58 HH, 12 Senn. MD-46 HH, 6 Beyer MC836 short shotgun, 6 Beyer MC837 long shotgun, 6 Senn. MKH 416 shotgun, 6 E-V 635A HH, 6 Sony ECM 66 lav, 6 Sony ECM 77 lav	GV Kayenne, 3M/E	2 6-ch. EVS XT2+ LSM, 2 4-ch. XT2+ R0, 1 4-ch. XT2+ SpotBox, 1 XFile; 2 Sony DWW A500 DigiBeta VTR; 2 Panasonic AJHD1800P DVCPRO; 4 DVD/VHS recorders	Evertz EQX HD video (396x684), Evertz EMX audio (384x384 AES, 256x256 MADI, 288x288 analog, 128x128x16 HD-SDI embedded)
8 Senn. HMD 25 headset, 8 Studio Technologies 210 talkback/cough box, 6 Beyer M58 HH, 10 Senn. MD-46 HH, 6 Beyer MC836 short shotgun, 6 Beyer MC837 long shotgun, 6 Senn. MKH 416 shotgun, 6 E-V 635A HH, 6 Sony ECM 66 lav, 6 Sony ECM 77 lav	GV Kayenne, 3M/E	2 6-ch. EVS XT2 LSM, 3 4-ch. XT2 R0, 1 4-ch. XT2 SpotBox, 1 XFile; 1 Sony DWW A500 DigiBeta VTR, 2 HDW D-1800 VTR; 4 DVD/VHS recorders	PESA HD video (288x576), PESA DRS mono audio (704x576 AES and analog)
8 Senn. HMD 25 headset, 8 Studio Technologies 210 talkback/cough box, 6 Beyer M58 HH, 12 Senn. MD-46 HH, 6 Beyer MC836 short shotgun, 6 Beyer MC837 long shotgun, 6 Senn. MKH 416 shotgun, 6 E-V 635A HH, 6 Sony ECM 66 lav, 6 Sony ECM 77 lav	GV Kayenne, 4.5M/E	3 6-ch. EVS XT2 LSM; 2 4-ch. XT2 R0, 1 6-ch. XT2 R0, 1 4-ch. XT2 SpotBox, 1 XFile; 1 Sony DWW A500 DigiBeta VTR; 1 Panasonic AJ HD 1800A DVCPRO VTR; 4 DVD/VHS recorders	PESA HD video (384x720), PESA DRS mono audio (2048x2048 AES, analog, & MADI)
8 Senn. HMD 25 headset, 8 Studio Technologies 210 talkback/cough box, 6 Beyer M58 HH, 12 Senn. MD-46 HH, 6 Beyer MC836 short shotgun, 6 Beyer MC837 long shotgun, 6 Senn. MKH 416 shotgun, 6 E-V 635A HH, 6 Sony ECM 66 lav, 6 Sony ECM 77 lav	GV Kayenne, 4.5M/E	2 6-ch. EVS XT2 LSM, 3 4-ch. XT2 R0, 1 4-ch. XT2 SpotBox, 1 XFile; 1 Sony DWW A500 DigiBeta VTR, 1 HDW M-2000 VTR; 1 Panasonic AJ HD 1800A DVCPRO VTR; 4 DVD/VHS recorders	PESA HD video (288x576), PESA DRS mono audio (704x576 AES and analog)
8 Senn. HMD 25 headset, 8 Daltech talkback/cough box, 6 Beyer M58 HH, 12 Senn. MD-46 HH, 6 Beyer MC836 short shotgun, 6 Beyer MC837 long shotgun, 6 Senn. MKH 416 shotgun, 6 E-V 635A HH, 6 Sony ECM 66 lav, 6 Sony ECM 77 lav	GV Kayenne, 3M/E	2 6-ch. EVS HD XT2 LSM, 3 4-ch. XT2 R0, 1 SpotBox, 1 XFile; 1 Sony DWW A500 DigiBeta VTR; 1 Panasonic AJ HD 1700A DVCPRO VTR; 2 HiFi VHS, 2 DVD recorders	Evertz EQX HD video (288x288 + 288 XLink), NVision mono audio (512x512 AES and analog)
8 Senn. HMD 26 headset, 8 Daltech talkback/cough box, 12 Senn. MD-46 HH, 6 Senn. MKH 416 shotgun, 2 Senn. MKH 418S stereo shotgun, 4 AT-BP4071L long shotgun, 6 E-V RE50 HH, 12 Sony ECM 77 lav	GV Kayenne K-Frame, 4.5M/E	3 6-ch. EVS XT3 LSM, 3 6-ch. XT3 R0, 1 4-ch. XT3 SpotBox, 5 LSM Connect Tablets, 1 IPDirector, 1 C-Cast Agent, 1 Database Server, 1 XT Access, 1 XFile; 3 Sony DWW A500 DigiBeta VTR; 2 Panasonic DVCPRO AJ-HD1700; 2 DVD/VHS recorders; 2 Mini Mac/Blackmagic H264 disc recorders	576x1152 multiformat video router with 128x128 embedded mux/demux capability, 192x192 AES audio (384x384 mono ch.), 288x288 analog audio, 16x16 MADI (1024x1024 mono ch.), 128x128 video I/O with 16 ch. of embedded audio each (2048x2048)
8 Senn. HMD 26 headset, 8 Studio Technologies 210 talkback/cough box, 6 Beyer M58 HH, 12 Senn. MD-46 HH, 6 Beyer MC836 short shotgun, 6 Beyer MC837 long shotgun, 6 Senn. MKH 416 shotgun, 6 E-V 635A HH, 6 Sony ECM 66 lav, 6 Sony ECM 77 lav	GV K-Frame, 4.5M/E	3 12-ch. EVS XT3 LSM, 1 4-ch. XT3 SpotBox, 1 XFile; 3 Panasonic DVCPRO AJ-HD1700; 4 DVD/VHS recorders	576x1152 multiformat video router with 128x128 embedded mux/demux capability, 192x192 AES audio (384x384 mono ch.), 288x288 analog audio, 16x16 MADI (1024x1024 mono ch.), 128x128 video I/O with 16 ch. of embedded audio each (2048x2048)

**EXPERIENCE.**



**PERFORMANCE.**



**RELIABILITY.**

**Inspired by *Visionary Design*, Committed to Engineering Excellence**

For more than three decades, F&F Productions has remained a first choice of veteran producers worldwide for all major league sports, network series and entertainment specials, live concerts, and large-scale corporate events for Fortune 500 companies.

Our commitment to our clients remains driven by the goals created for our launch – our 'get it done' attitude and relentless drive for engineering excellence, backed by our renowned 24/7 technical support and unparalleled customer service.

Simply put, F&F Productions believes the true measure of our success is our client's success and the most important event we'll ever produce is yours!

14333 Myerlake Circle | Clearwater, FL 33760 | 1 (727) 530-5000 | [fandfhd.tv](http://fandfhd.tv)

# HIGH STAKES?

CALL THE EXPERTS AT  
DIGITAL NETWORK ASSOC.



HD MOBILE UNITS  
FULL BROADCAST STUDIO  
HOUSTON, TEXAS  
281.657.7292

[DNAWEBS.COM](http://DNAWEBS.COM)

24/7 Mobile and Studio Booking

HD Trucks for Sports and Entertainment

Studio - 3,000 sq ft with IP XMIT

24ft Green Screen

Book today for Final Four and Super Bowl 2017



COMPANY	TRUCK NAME	DIMENSIONS/ TYPE	SD/ HD/1080P/4K- CAPABLE	TRIAx, FIBER, OR BOTH?	AUDIO CONSOLE (FADERS/CHANNELS)	# CAMERAS & MAKE	LENSES (H/HH)	GRAPHICS
<b>GAME CREEK VIDEO</b>	PeacockOne	2 53' expandos	HD/1080p/4K	Both	Calrec Apollo w/ Bluefin (144/1,020)	23 Sony HDC-4300	6 Canon DigiSuper 100X9.3, 6 Canon DigiSuper 95X8.6, 8 Canon 22X7.8 ENG, Canon 14X4.7 ENG	ChyronHego Mosaic
	Encore	3 53' expandos	HD/1080p	Both	Calrec Apollo w/ Bluefin (144/1,020)	14 Sony HDC-4300	6 Canon DigiSuper 100X9.3, 4 Canon DigiSuper 95X8.6, 4 Canon 22X7.8 ENG, 4 Canon 14X4.7 ENG	ChyronHego Mosaic
	Madison	53' expando	HD/1080p/4K	Both	Calrec Apollo w/ Bluefin (144/1,020)	12 Sony HDC-4300	6 Canon DigiSuper 95, 3 Canon 24X7.8 ENG, 3 Canon 14X4.7 ENG	ChyronHego Mosaic
	NITRO	53' expando	HD/1080p/4K	Both	Calrec Artemis (144/1,020)	12 Sony HDC-2500	6 Canon DigiSuper 95, 3 Canon 24X7.8 ENG, 3 Canon 14X4.7 ENG	ChyronHego Mosaic
	Chesapeake	53' expando	HD/1080p/4K	Both	Calrec Artemis (144/1,020)	13 Sony HDC-4300	9 Canon DigiSuper 95, 3 Canon 24X7.8 ENG, 3 Canon 14X4.7 ENG	ChyronHego Mosaic
<b>GEARHOUSE BROADCAST</b>	BCX-2	3 ton truck	HD/SD	Triax	Yamaha	10 Sony	Fujinon	As requested
	HD-1	Double expando	HD/SD	Both	Lawo	30 Sony	Fujinon	As requested
	HD-3	Single expando	HD/1080p	Both	Euphonix	26 Hitachi/Sony	Fujinon	As requested
	HD-4	Single expando	HD/SD	Triax	Lawo	16 Sony	Fujinon	As requested
	HD-5	Double expando	HD/1080p	Both	Lawo	40 Hitachi/Sony	Fujinon	As requested
	HD-6	Double expando	HD/1080p	Both	Lawo	40 Hitachi/Sony	Fujinon	As requested
	HD-7	Double expando	HD/1080p	Both	Lawo	40 Hitachi/Sony	Fujinon	As requested
	HD-8	Double expando	HD/1080p/4K	Both	Lawo	40 Hitachi/Sony	Fujinon	As requested
	HD-9	Double expando	HD/1080p	Both	Lawo	34 Hitachi/Sony	Fujinon	As requested
	HD-10	Single expando	HD/1080p	Both	Lawo	30 Hitachi/Sony	Fujinon	As requested
	Columbus	Single expando	HD/4K	Both	Lawo	32 Hitachi/Sony	Canon	As requested
<b>HRS MOBILE</b>	HRS-TV1	40' expando	HD	Triax	Yamaha DM-2000 (24/96)	8 GV LDK Elite	1 72X H, 2 55X H, 2 wide- angle, 3 15X, 1 22X HH	ChyronHego Duet HyperX 2
<b>IMS PRODUCTIONS</b>	HD-1	53' expando	HD	Both	Calrec Sigma (64/256)	8 Sony HDC-1000 studio, 8 Sony HDC handheld, 4 Sony HDLA-1500	Canon (10 H/8 HH)	ChyronHego Mosaic XL
	HD-2	53' expandoplus a second control room and expando	HD	Both	Calrec Sigma (64/256)	4 Sony HDC-1000 studio, 4 Sony HDC handheld, 2 Sony HDLA-1500	Canon (6 H/4 HH)	ChyronHego Mosaic XL
	HD-3	53' expando	HD/1080p	Both	Calrec Artemis Beam (64/544)	10 Sony HDC-2400L, 2 Sony HDC-2500L	6 Canon HH 22X, 4 Canon XJ95X8.6, 5 Canon XJ80X8.8	2 ChyronHego Mosaic EFX XL
	HD-4	53' expando	HD	Triax	SSL (56/128)	12 Grass Valley LDK 8000	4 Canon 22X HH, 8 Canon hard	ChyronHego HyperX3
	HD-5	53' double expando	HD/1080p	Both	Calrec Apollo (144/1,504)	14 Sony HDC-2400, 4 Sony HDC-2500	8 Canon 22X HH, 6 Canon 100X9.3, 6 Canon 95X8.6	2 ChyronHego Mosaic EFX XL
<b>JAS DIGITAL</b>	New Wave	30'	HD	Fiber	Yamaha M7CL (32)	8 Sony	8 Fujinon	ChyronHego HyperX2
<b>JONES MOBILE TV</b>	VisionHD	51' expando	HD	Both	Calrec Summa (44/128)	8 Sony HDC-2400	10 Fujinon, 4 88X, 2 77X, 3 23X, 1 14X	ChyronHego Duet HyperX3

MICROPHONES	SWITCHER, M/E	NUMBER REPLAY DEVICES	ROUTER (VIDEO/AUDIO SIZE)
8 Senn. HMD 26 headset, 8 Studio Technologies 210 talkback/cough box, 12 Senn. MD-46 HH, 6 Senn. MKH 416 shotgun, 6 Senn. MKH 418S stereo shotgun, 6 Senn. 8070 shotgun, 4 A-T BP4027 long stereo shotgun, 6 E-V RE50 HH, 6 Sony ECM 77 lav	GV Kayenne K-Frame, 9M/E	21 6-ch. EVS XT3 LSM, 3 6-ch. XT2+ SpotBox, 2 XFile3; 1 Sony DVW A500 DigiBeta VTR; 1 Panasonic DVCPRO AJ-HD1700; 4 DVD/VHS recorders	2 576x1152 multiformat video router with 128x128 embedded mux/demux capability, 192x192 AES audio (384x384 mono ch.), 288x288 analog audio, 16x16 MADI (1024x1024 mono ch.), 128x128 video I/O with 16 ch. of embedded audio each
6 Senn. ME66, 6 Senn. ME67, 6 Senn. MKH 416, 6 Senn. MKH 418, 6 Senn. MKH 8070, 12 Senn. MD 46, 10 Senn. HMD 26 II announce headset, 4 A-T 4050ST, 6 Sony ECM 77B	GV Kayenne K-Frame, 9M/E	10 6-ch. EVS XT3 LSM, 1 6-ch. XT2+ SpotBox, 2 XFile3; 1 Sony DVW A500 DigiBeta VTR; 1 Panasonic DVCPRO AJ-HD1700; 4 DVD/VHS recorders	A unit: 968x2214 multiformat video router with 468x378 embedded mux/demux capability, 192x192 AES audio (384x384 mono ch.), 192x288 analog audio, 37x37 MADI, 468x378 video I/O with 16 ch. of embedded audio, IHSE Draco Tera KVM router 192-port matrix with RS data transportB unit: 96x96 AES audio (192x192 mono ch.), 48x96 analog audio (96x192 mono ch.), 12x12 MADI unit: 96x96 AES audio (192x192 mono ch.), 48x96 analog audio (96x192 mono ch.), 12x12 MADI
8 Senn. HMD 26 headset, 8 Studio Technologies 210 talkback/cough box, 12 Senn. MD-46 HH, 6 Senn. MKH 416 shotgun, 6 Senn. MKH 418S stereo shotgun, 6 Senn. 8070 shotgun, 4 A-T BP4027 long stereo shotgun, 6 E-V RE50 HH, 6 Sony ECM 77 lav	GV Kayenne K-Frame, 9M/E	3 12-ch. EVS XT3 LSM, 1 4-ch. HD XT3 SpotBox, 1 XFile3; 1 Panasonic DVCPRO AJ-HD1700; 4 DVD/VHS recorders	576x1152 multiformat video router with 128x128 embedded mux/demux capability, 192x192 AES audio (384x384 mono ch.), 288x288 analog audio, 16x16 MADI (1024x1024 mono ch.), 128x128 video I/O with 16 ch. of embedded audio each
8 Senn. HMD 26 headset, 8 Studio Technologies 210 Talkback/cough box, 12 Senn. MD-46 HH, 6 Senn. MKH 416 shotgun, 6 Senn. MKH 418S stereo shotgun, 6 Senn. 8070 shotgun, 4 A-T BP4027 long stereo shotgun, 6 E-V RE50 HH, 6 Sony ECM 77 lav	GV Kayenne K-Frame, 9M/E	3 12-ch. EVS XT3 LSM, 1 4 -ch. XT3 SpotBox, 1 XFile3; 1 Panasonic DVCPRO AJ-HD1700; 4 DVD/VHS recorders	576x1152 multiformat video router with 128x128 embedded mux/demux capability, 192x192 AES audio (384x384 mono ch.), 288x288 analog audio, 16x16 MADI (1024x1024 mono ch.), 128x128 video I/O with 16 ch. of embedded audio each
8 Senn. HMD 26 headset, 8 Studio Technologies 210 Talkback/cough box, 12 Senn. MD-46 HH, 6 Senn. MKH 416 shotgun, 6 Senn. MKH 418S stereo shotgun, 6 Senn. 8070 shotgun, 4 A-T BP4027 long stereo shotgun, 6 E-V RE50 HH, 6 Sony ECM 77 lav	GV Kayenne K-Frame, 9M/E	4 12-ch. EVS XT3 LSM, 1 4-ch. XT3 SpotBox, 1 XFile3; 1 Panasonic DVCPRO AJ-HD1700; 4 DVD/VHS recorders	576x1152 multiformat video router with 128x128 embedded mux/demux capability, 192x192 AES audio (384x384 mono ch.), 288x288 analog audio, 16x16 MADI (1024x1024 mono ch.), 128x128 video I/O with 16 ch. of embedded audio each
	Sony	1 EVS	Sony
	Sony	8 EVS XT3	Sony
	Sony	4 EVS XT3	Probel 200x256
	Sony	4 EVS XT3	Probel 288x384
	Sony	8 EVS XT3	Miranda 314x522
	Sony	8 EVS XT3	Miranda 314x522
	Sony	8 EVS XT3	Miranda 314x522
	Sony 4K	7 EVS XT3	Miranda 314x522
	Sony	4 EVS XT3	Miranda 288x576
	Sony	8 EVS XT3	Sony
	Grass Valley	4 EVS ChannelMax	Imagine 504x448
12 shotgun, 6 HH	GV Kalypso, 4M/E	2 EVS with Xfile	HD/SD router (288x288)
8 Senn. HMD 26 announce headset, 8 announce boxes with talkback, 8 Senn. ME 66 short shotguns, 8 Senn. ME 67 long shotguns, 4 BP4027 stereo shotgun, 6 Shure Beta 58, 6 E-V 635, 4 E-V RE 50, 6 Sony ECM 77, 4 Sony ECM 66	GV Kalypso	2 6-ch. EVS XT2 LSM, 4 6-ch. XT2 RO, 4-ch. SpotBox, Xfile, Sports Hub; AJ-HD-1800 DVCPRO; PDW75 Xdcam, 2 DVD recorders	GV NVision with Jupiter Control (288x236 HD/SD/224x256 AES, 192x192 analog)
6 Senn. HMD 25 announce headset, 6 announce box, 5 Senn. ME 66 short shotgun, 5 Shure SM 89 long shotgun, 5 BP4027 stereo shotgun, 2 VP 88 stereo, 4 Shure Beta 58, 4 Senn. MD 4, 64 Sony ECM 77, 4 Sony ECM 66,	GV Kayenne, 4.5M/E	2 6-ch. EVS XT2 LSM, 1 6-ch. XT-2 RO, 1 4-ch. EVS XT2 RO, 1 4-ch. SpotBox, Xfile, Sports Hub; 2 AJ-HD-1800 DVCPRO; 2 HDW-1800 HD Cam; 2 DVD recorders	GV NVision with Jupiter Control (288x504 HD/SD/224x256 AES, 192x192 analog)
6 Senn. HMD 26 announce headset, 6 announce box, 6 Senn. ME 66 short shotguns, 6 Senn. ME 67 long shotguns, 6 Senn. MKH 416 shotgun, 2 VP 88 stereo, 8 Senn. MD 48, 6 Sony ECM 77, 2 Sony ECM 66	GV Kayenne K-Frame, 5M/E	1 Sony HDWD 1800 HDCAM, IMX, DIGIBETA, SX; 1 Sony HDW 1800 HDCAM; 2 Sony PDWHD 1500 XDCAM; wired for 8 tape machines; 2 6-ch. EVS XT3 LSM; 3 6-ch. XT3 RO, 1 6-ch. XS SpotBox, 1 XFile2/3, 1 IPDirector	Evertz EQX (314x314 3G/HD/SD, of which 80x80 support audio, 96x96 stereo analog, 96x96 unbalanced AES, 19x19 MADI)
8 Senn. HMD 25 announce headset, 12 Sony ECM77B lav, 10 Senn. ME-66 shotgun, 8 Senn. MKH-416P shotgun, 8 Senn. MKH-70-P48 shotgun, 8 E-V RE-50 HH, 8 E-V 635B HH	GV Kalypso	2 6-ch. EVS LSM XT2, 1 4-ch. XT2 RO, SpotBox, IPDirector, XFile; wired for 2 additional 6-ch. EVS; 1 Panasonic AJ-HD1800 DVCPRO; 1 Sony PDW-F75 HD VTR, 1 HDW-D1800 HDCAM/DigiBeta, 1 HDW-M2000 HDCAM/DigiBeta	Evertz EQX (288x288 HD/SD), NVision (256x256 unbalanced AES)
8 HMD-26 announcer headset, 6 Senn. MKH-816 shotgun, 6 Senn. MKH-416 shotgun, 6 Senn. ME-66 shotgun, 4 A-T AT-4029 stereo shotgun, 12 Senn. MD-46, 2 Shure VP-88 stereo, 2 E-V RE50, 8 Sony ECM-77 lav	GV Kayenne K-Frame, 7M/E	1 Sony HDW-D1800 HDCam, 1 SRW-HDCam, 2 PDWHD 1500 XDCam; 1 Panasonic 1800 DVCPRO; 2 8-ch. EVS XT3 LSM, 4 8-ch. XT3 RO, licensed for slo-mo, 1 6-ch. XS3 SpotBox, 1 XFile2 with XT Access, 1 IPDirector	Evertz EQX (314x1276 3G/HD/SD, of which 160x160 support audio, 96x96 stereo analog audio, 96x96 unbalanced AES, 34x34 MADI)
Shure	Sony MFS-2000, 1.4M/E	EVS available upon request	Harris Panace video (32x32 HD-SDI), Harris Panace audio (32x32 HD-SDI analog)
A-T, Sony, E-V,	GV Kayenne, 4.5M/E; GV Kayenne	1 12-ch. EVS LSM XT3, 4-ch. XT3 RO, 4-ch. XS SpotBox, XFile3; HDCAM, DVCPRO, DigiBeta, DVD	PESA Cheetah 64XE, PESA CHEETAH DRS (128x128)



**REDEFINING TELEVISION**

 *GAME CREEK VIDEO*

[gamecreekvideo.com](http://gamecreekvideo.com)

603.882.5222

The very newest state of the art  
UPS systems—unlimited capacity  
in 400 amp increments



Two new touring  
UPS systems—  
WWE and TNF



# FILMWERKS

INTERNATIONAL INC

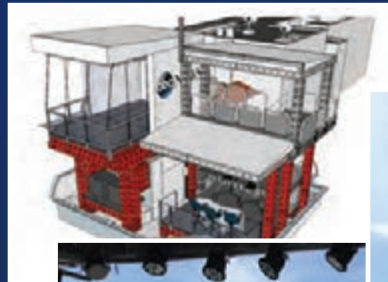

**Your ideas have no boundaries; we will build anything, anywhere!**

Air Conditioning • Heat • Generators • Structures • Design • Engineering • In-House Fabrication • Asset Management • Lighting • Transportation

Nationwide & Overseas Service | 910.675.1145 | [www.filmwerksintl.com](http://www.filmwerksintl.com)

COMPANY	TRUCK NAME	DIMENSIONS/ TYPE	SD/HD/1080P/ 4K-CAPABLE	TRIAx, FIBER, OR BOTH?	AUDIO CONSOLE (FADERS/CHANNELS)	# CAMERAS & MAKE	LENSES (H/HH)	GRAPHICS
<b>KODIAK MOBILE TELEVISION</b>	Grizz HD	45'	HD	Triax	Calrec Omega (40/80)	7 GV LDK 3000+, 2 Panasonic HPX 250	3 Fujinon XA77X9.5BESM, 3 Fujinon ZA17X7.6BERM, 1 Fujinon ZA12X4.5BERM, 5 studio viewfinders (3 hard/2 HH)	ChyronHego HyperX3
<b>LESEA PRODUCTIONS</b>	S1	38'	SD	Triax	Allen Heath (32 channels)	5 GV LDK 400	Canon	ChyronHego Duet
	S2	40' expando	HD	Triax	Calrec Artemis Light (40 faders)	6 GV LDX 80	3 Fujinon 77X1, 3 Fujinon 22X1	ChyronHego Mosaic, Vizrt Trio
<b>LIVE MEDIA GROUP</b>	HD-1	38' expando	HD	SMPTE fiber	Yamaha M7CL; Avid S3	5 GV LDK 8000	1 Fujinon 72X, 2 Fujinon 22X, 2 Fujinon 12X wide-angle	Wired for 1
	HD-2	38' expando	HD	SMPTE fiber	Yamaha DM2000; Avid S3	5 GV LDK 8000	1 Fujinon 72X, 2 Fujinon 22X, 2 Fujinon 12X wide-angle	Wired for 1
	HD-3	40' expando	HD	SMPTE fiber	Avid S3	5 Sony HDC-1500R	1 Canon 86X, 2 Fujinon 22X, 2 Fujinon 12X wide-angle	Wired for 1
	HDX-6	32'	HD	Triax (SMPTE)	Allen & Heath WZ3	3 GV LDK 6000, Sony 1500R		N/A
	HDX-7	40' expando	HD	Triax	Yamaha PM 5D	6 GV LDK 8000	3 Angenieux 70X, 2 Angenieux 19X, 1 Angenieux 10X wide-angle	ChyronHego Duet HyperX3 (3.1)
	HDX-8	40' expando	HD	Triax	Yamaha PM 5D	6 GV LDK 8000	3 Angenieux 70X, 2 Angenieux 26X, 1 Angenieux 10X wide-angle	ChyronHego Duet HyperX2
	HDX-9	40' expando	HD	Triax	DiGiCo SD5	6 GV LDK 8000	3 Canon 86X, 2 Canon 22X, 1 Canon 12X wide-angle	ChyronHego Duet LEX
	HDX-10	42' expando	HD	Triax	DiGiCo SD5	6 GV LDX 80	3 Canon 86X, 2 Canon 22X, 1 Canon 14X wide-angle	ChyronHego Duet LEX
	HD-11	51' expando	HD	Triax	Calrec Omega (5.1)	10 LDK 3000	1 Angenieux 70X, 3 Angenieux 62X, 2 Angenieux 26X, 1 Angenieux 19X, 1 Angenieux 15X, 1 Canon 21X, 1 Canon 18X, 1 Fujinon 12X wide-angle	ChyronHego Duet HyperX
<b>LYON VIDEO</b>	Lyon 3	43' expando	HD	Triax and fiber	Calrec Artemis (56/240)	6 GV	5 Fujinon 72X, 1 Fujinon 22X, 1 Fujinon 18X, 1 Fujinon 12X	Client supplied
	Lyon 4	43' expando	HD	Triax and fiber	Calrec Artemis (56/240)	5 GV	4 Fujinon 72X, 1 Fujinon 22X, 1 Fujinon 18X, 1 Fujinon 12X	Client supplied
	Lyon 5	53' expando	HD	Triax	Calrec Q2 (120/120)	10 GV	1 Fujinon 101X, 3 Fujinon 87X, 2 Fujinon 72X, 3 Fujinon 22X, 1 Fujinon 12X	ChyronHego Hyper X3
	Lyon 6	53' expando	HD	Triax/fiber	Calrec Alpha (72/480)	10 GV, 1 GV Extreme SSMO	1 Fujinon 101X, 5 Fujinon 87X, 1 Fujinon 72X, 4 Fujinon 22X, 1 Fujinon 12X	ChyronHego HyperX3
	Lyon 7	53' expando	HD	Triax	Calrec Sigma (64/320)	10 GV, 1 GV Extreme SSMO	1 Fujinon 101X, 5 Fujinon 87X, 1 Fujinon 72X, 4 Fujinon 22X, 2 Fujinon 12X	Vizrt, ChyronHego HyperX3
	Lyon 8	53' expando	HD	Triax/fiber	Calrec Sigma (64/320)	12 GV	1 Fujinon 101X, 5 Fujinon 88X, 1 Fujinon 72X, 2 Fujinon 22X, 2 Fujinon 18X, 2 Fujinon 12X	Vizrt, ChyronHego HyperX3
	Lyon 9	50' expando	HD	Traix/fiber	Calrec Omega (56/160)	9 GV	1 Fujinon 101X, 2 Fujinon 87X, 3 Fujinon 72X, 4 Fujinon 22X, 1 Fujinon 12X	Vizrt, ChyronHego HyperX3
	Lyon 10	53' expando	HD	Triax	Calrec Omega (56/160)	10 GV	1 Fujinon 101X, 3 Fujinon 88X, 3 Fujinon 72X, 4 Fujinon 22X, 1 Fujinon 12X	Vizrt, ChyronHego HyperX3
	Lyon 11	53' expando	HD/1080p	Triax/fiber	Calrec Apollo (144/1,020)	12 GV	1 Fujinon 101X, 4 Fujinon 88X, 2 Fujinon 72X, 2 Fujinon 22X, 2 Fujinon 18X, 2 Fujinon 12X	ChyronHego HyperX3
	Lyon 12	53' expando	HD/1080p	Triax/fiber	Calrec Artemis (64/340)	12 GV	1 Fujinon 101X, 3 Fujinon 88X, 3 Fujinon 72X, 2 Fujinon 22X, 2 Fujinon 18X, 2 Fujinon 12X	Vizrt, ChyronHego HyperX3
	Lyon 14	53' expando	HD/1080p	Triax/fiber	Calrec Apollo (144/1,020)	12 GV	5 Fujinon 99X, 2 Fujinon 72X, 2 Fujinon 22X, 2 Fujinon 18X, 2 Fujinon 12X	Vizrt, ChyronHego HyperX3
	<b>METROVISION</b>	HD-1	40' expando	HD	Both	Studer Vista 5 (32 AES, 32 analog)	6 Sony HDC-1500	3/3 +
HD-2		40' expando	HD	Both	Calrec Omega w/Bluefin (64 AES, 64 analog)	6 Sony HDC-1500	4/2 +	ChyronHego HyperX3
HD-3		40'	HD	Both	Midas M32 (40 ch.)	5 Sony HDC-1500	2/3 +	ChyronHego Duet LEX 2
HD-5		40' expando	HD	Both	Calrec Omega (32 AES, 64 analog)	7 Sony HDC-1400	4/4 +	ChyronHego Duet HyperX3
<b>MOBILE TV GROUP</b>	Puma HD-2	32' expando	HD	Triax	Allen & Heath (40/40)	5 GV LDK 8000 Elite	Canon (3 H/2 HH)	ChyronHego HyperX
	8HDX	53' expando	HD	Triax	Euphonix System 5-B (48/160)	8 GV LDK 8000 Elite	Canon (6 H/3 HH)	ChyronHego HyperX
	12HDXs	53' expando	HD	Triax	Euphonix System 5-B (48/160)	8 GV LDK 8000 Elite	Canon (6 H/3 HH)	ChyronHego HyperX
	16HDX	53' expando dual feed	HD	Triax/SSMO fiber	Euphonix System 5-B (48/160)	9 GV LDX 80, 2 GV 6X SSMO	Canon (8 H/4 HH)	
	20HDX	53' expando dual feed	HD	Triax/SSMO fiber	Euphonix System 5-B (48/160)	9 GV LDX 80, 2 GV 6X SSMO	Canon (8 H/4 HH)	2 Vizrt, 1 ChyronHego HyperX



MICROPHONES	SWITCHER, M/E	NUMBER REPLAY DEVICES	ROUTER (VIDEO/AUDIO SIZE)
5 Senn. HMD-26 announcer headset, 3 Senn. HMD-25 announcer headset, 7 A-T AT8015 shotgun, 7 A-T BP4027 stereo shotgun, 4 Sony ECM-77 lav, 4 Senn. MD-46 HH, 2 Shure SM-58 HH, 2 E-V, RE-50 HH, 5 Studio Technologies 210 announcer box, 1 booth kit with announcer box, headset, IFB box and earpieces	GV Kayenne, 2.5M/E	2 6-ch. EVS XTnano, XT Access/XFile; 8-ch. Tightrope ZEPLAY; 2 Panasonic AJ HD1400 DVCPRO HD decks, AG-HPD24PJ recorder/player; Sony HDW 1800 HD Cam recorder, DVM A500 DigiBeta; 2 DVD recorders	Utah Scientific 400S (720x24 HD-SDI I/O with embedding and de-embedding, 64x64 AES I/O, 192x192 MADI I/O, 1024x1024 audio crosspoint matrix)
2 Lectrosonic	GV Zodiak, 2.5M/E	EVS 2 Record - 2 Playback; 2 Sony PWV-2800 Beta SP player/recorder; 2 BWV-75 SP slo-mo player/recorder w/ 1 DNF Controller	GV Concerto (32x32)
Senn., Sony	GV Kayenne, 4M/E	6-ch. EVS XT3 LSM, 4-ch. XT3 RO; Panasonic DVCPRO HD; Blackmagic	GV NVision (138x249 with integrated AES audio)
As requested	GV Kalypso, 2.5M/E	Wired for 2	GV Concerto (32x32)
As requested	GV Kalypso, 2.5M/E	Wired for 2	GV Concerto (32x32)
As requested	Ross Carbonite, 2.5M/E	Wired for 1	Ross (72x72)
As requested	Ross Synergy, 1M/E	Wired for 1	Leitch (16x16)
As requested	GV Kalypso, 4M/E	1 6-ch. EVS XT-3, 1 4-ch. XT2, 1 XFile2	GV Concerto (32x32)
As requested	GV Kalypso, 2 M/E	1 6-ch. EVS XT2, 1 4-ch. XT2 RO, 1 XFile2	GV Concerto 32x64
As requested	GV Karrera, 4M/E	1 6-ch. EVS XT3, 1 6-ch. XT2, 1 XFile3	GV Trinx (96x64)
As requested	GV Kayenne, 4M/E	1 6-ch. EVS XT3, 1 6-ch. XT2, 1 XFile2	Utah Scientific (216x324)
As requested	GV Kayenne, 3.5M/E	1 6-ch. EVS XT2, 1 4-ch. XT2, 1 4-ch. XT RO, 1 2-ch. XT SpotBox, 1 XFile2	Miranda (162x286)
Senn., A-T	GV Kalypso, 3M/E	2 6-ch. EVS, 1 4-ch. RO SpotBox	Evertz (280x442/1312x1696)
Senn., A-T	GV Kalypso, 3M/E, SS	2 6-ch. EVS, 1 4-ch. RO SpotBox	Evertz (280x442/1312x1696)
Senn., A-T	GV Kalypso, 4M/E	2 6-ch. EVS, 1 4-ch. RO, 1 4-ch. RO/SpotBox	Grass Valley V 256x448, A 256x256
Senn., A-T	GV Kayenne, 4.5M/E	2 6-ch. EVS, 2 4-ch. RO, 1 4-ch. RO SpotBox, 1 8-ch. Summit/Dyno	Evertz (270x520/704x800)
Senn., A-T	GV Kayenne, 4.5M/E	2 6-ch. EVS, 2 4-ch. RO, 1 4-ch. RO SpotBox, 1 8-ch. Summit/Dyno	GV (128x128/512x512)
Senn., A-T	GV Kayenne, 4.5M/E	2 6-ch. EVS, 2 4-ch. RO, 1 4-ch. RO SpotBox	PESA (256x496/512x512)
Senn., A-T	GV Kalypso, 4M/E	2 6-ch. EVS, 2 4-ch. RO, 1 4-ch. RO SpotBox	GV (256x448/256x256)
Senn., A-T	GV Kayenne K-Frame, 5M/E	2 6-ch. EVS, 2 4-ch. RO, 1 4-ch. RO SpotBox	GV (256x448/256x256)
Senn., Beyer, A-T	GV Kayenne K-Frame, 5M/E	6 6-ch. EVS, 1 4-ch. RO SpotBox	Evertz (492x746/2016x2016)
Senn., Beyer, A-T	GV Kayenne K-Frame, 5M/E	4 6-ch. EVS, 1 4-ch. RO, 1 4-ch. RO SpotBox	Evertz (280x802/1344x1504)
Senn., Beyer, A-T	GV Kayenne K-Frame, 5M/E	2 8-ch. EVS, 2 6-ch. EVS, 1 4-ch. RO SpotBox, 1 6-ch. Summit/Dyno	Evertz (460x902/2720x3328)
8 shotgun, 4 lav, 4 HH	GV Kalypso, 4M/E	2 EVS XT2/ SpotBox/XFile3	Leitch Platinum (256x256/128x136 HD-SDI/32x32 analog)
6 shotgun, 2 lav, 3 HH	GV Kalypso, 4M/E	2 EVS XT2	Leitch Platinum (256x256/112x96 HD-SD/8x8 analog)
6 shotgun, 2 lav, 3 HH	Sony MVS-8000A, 2.5M/E	1 EVS XT2	Leitch (64x64 HD/32x32 analog, 64x64 audio)
11 shotgun, 6 lav, 5 HH	GV Kayenne, 2.5 M/E	2 EVS XT2/XFile/XHub	Evertz Xenon (128x128)
Senn., Sony, E-V	GV Kayak, 3M/E	1 EVS 4-ch. XT2 LSM, 14-ch. XT2 RO, XFile2; DVD	PESA HD video (64x64), PESA audio (32x32)
A-T, Senn.	GV Kalypso, 4M/E	3 6-ch. EVS XT2 LSM, 1 4-ch. XT2 RO, 4-ch. SpotBox, XFile3	GV video (128x320), Euphonix audio (258x270)
A-T, Senn.	GV Kalypso, 4M/E	2 6-ch. EVS XT2 LSM, 4-ch. XT2 LSM, 4-ch. XT2 RO, 4-ch. SpotBox, XFile3; DVD	GV video (128x256), Euphonix audio (258x270)
A-T, Senn., E-V,	GV Kayenne, 4.5M/E	3 6-ch. EVS XT2 LSM, 4-ch. XT2 LSM, 1 4-ch. XT2 RO, 4-ch. SpotBox, 2 XFile3; P2 Deck, DVD, GV K2 Dyno	PESA HD video (128x256), Euphonix audio (258x270)
A-T, Senn., E-V,	GV Kayenne, 4.5M/E	3 6-ch. EVS XT2 LSM, 4-ch. XT2 LSM, 1 4-ch. XT2 RO, 4-ch. SpotBox, 2 XFile3; P2 Deck, DVD, GV K2 Dyno	PESA video (128x288), Euphonix audio (258x270)



Whether it is **entertainment** or **main event sports**, **IMS Productions** has the facilities and experience to execute **ANY** event.

## Six state-of-the art HD trucks on the road and a fleet of support vehicles...

### HD 1

- 16 camera capability
- Kalypso switching
- Chyron Mosaic graphics
- Calrec audio

### HD 2

- 10 camera capability (expandable to 16)
- Kayenne switching
- Chyron Mosaic graphics
- Calrec audio

### HD 3

- 4K capable
- 12 camera capability
- Kayenne K frame switching
- Chyron Mosaic graphics
- Calrec audio

### HD 4

- 12 camera capability
- Kalypso switching
- Chyron graphics
- SSL audio

### HD 5

- 4K capable
- 20 plus camera capability
- Kayenne K frame switching
- Chyron Mosaic graphics
- Calrac audio

### D1

- 5 Camera Multi-Cam
- Evertz Router
- Evertz Multi-Viewer
- Broadcast Quality Shading Position



Our studios are HD deliverable via our in-house VVX circuit for all types of productions.

**Recent clients include: NBC SPORTS, ABC SPORTS, TIME WARNER CABLE, NBA, INDYCAR, PROFESSIONAL BULL RIDING, PAC 12 AND MANY MORE!**

Kevin Sublette

VP of Broadcast Operations  
ksublette@imsptv.com  
(317)-492-8723



[www.imsptv.com](http://www.imsptv.com)

Robby Greene  
President

rgreene@imsptv.com  
(317)-492-8710



an **ARRI** Rental company

## Broadcast Power & Lighting

- Expert Generator & Lighting Technicians
- Unmatched Quality and Performance • Specialized Equipment



Los Angeles  
818.686.6400

[www.illuminationdynamics.com](http://www.illuminationdynamics.com)

North Carolina  
704.679.9400

COMPANY	TRUCK NAME	DIMENSIONS/ TYPE	SD/HD/1080P/ 4K-CAPABLE	TRIAx, FIBER, OR BOTH?	AUDIO CONSOLE (FADERS/CHANNELS)	# CAMERAS & MAKE	LENSES (H/HH)	GRAPHICS
MOBILE TV GROUP	21HDX-U	48' expando	HD	Triax	Euphonix MaxAIR (56/108)	8 GV LDK 8000 Elite	Canon (6 H/4 HH)	1 Vizrt, 1 ChyronHego HyperX
	22HDX-U	48' expando	HD	Triax/SSMO fiber	Euphonix MaxAIR (56/108)	7 GV LDK 8000 Elite, 2 GV 6X SSMO	Canon (7 H/4 HH)	1 Vizrt, 1 ChyronHego HyperX
	23HDXs	48' expando	HD	Triax	Euphonix MaxAIR (56/108)	8 GV LDK 8000 Elite	Canon (6 H/3 HH)	1 Vizrt 1 ChyronHego HyperX
	24HDXs	48' expando	HD	Triax	Euphonix MaxAIR (56/108)	8 GV LDK 8000 Elite	Canon (6 H/3 HH)	1 Vizrt, 1 ChyronHego HyperX
	25HDX	53' expando	HD	Triax/SSMO fiber	Euphonix System 5-B (48/160)	6 GV LDX 80, 2 GV 6X SSMO	Canon (6 H/4 HH)	1 Vizrt, 1 ChyronHego HyperX
	26HDX	53' expando dual feed	HD	Triax/SSMO fiber	Euphonix System 5-B (48/160)	10 GV LDK 8000 Elite, 1 GV 6X SSMO	Canon (8 H/4 HH)	2 Vizrt, 1 ChyronHego HyperX
	27HDX	53' expando dual feed	HD	Triax/SSMO fiber	Euphonix System 5-B (56/160)	10 GV LDK 8000 3G, 1 GV 6X SSMO	Canon (8 H/4 HH)	2 Vizrt, 1 ChyronHego HyperX
	28HDX	53' expando dual feed	HD	Triax/SSMO fiber	Euphonix System 5-B (48/160)	8 GV LDX 80, 2 GV 6X SSMO	Canon (8 H/4 HH)	1 Vizrt, 1 ChyronHego HyperX
	29HDX	53' expando dual feed	HD	Triax/SSMO fiber	Calrec Artemis (48/128)	9 GV LDK 8000 Elite 3G, 2 GV 6X SSMO	Canon (8 H/4 HH)	1 Vizrt, 1 ChyronHego HyperX, 1 ChyronHego Mosaic XL
	30HDX	53' expando dual feed	HD	Triax/SSMO fiber	Calrec Artemis (48/128)	9 GV LDX 80, 2 GV 6X SSMO	Canon (8 H/4 HH)	1 Vizrt, 1 ChyronHego HyperX, 1 ChyronHego Mosaic XL
	31HDX	53' expando dual feed	HD	Triax/SSMO fiber	Calrec Artemis (48/128)	9 GV LDK 8000 Elite 3G, 2 GV 6X SSMO	Canon (8 H/5 HH)	2 Vizrt, 1 ChyronHego HyperX
	32HDX	53' expando dual feed	HD	Triax/SSMO fiber	Euphonix System 5-B (48/160)	9 GV LDK 8000 Elite 3G, 2 GV 6X SSMO	Canon (9 H/4 HH)	2 Vizrt, 1 ChyronHego HyperX
	33HDX/VMU33	SXS dual feed: A 53' expando, B 53'	HD	Triax/SSMO fiber	Calrec Artemis (48/320)	10 GV LDX 80, 2 GV 6X SSMO	Canon (8 H/5 HH)	2 Vizrt, 1 ChyronHego HyperX
	34HDX/VMU34	SXS dual feed: A 53' expando, B 53'	HD	Triax/SSMO fiber	Calrec Artemis (48/320)	10 GV LDX 80, 2 GV 6X SSMO	Canon (8 H/5 HH)	2 Vizrt, 1 ChyronHego HyperX
	35HDX/VMU35	SXS dual feed: A 53' expando, B 53'	HD	Triax/SSMO fiber	Calrec Artemis (56/320)	9 GV LDX 80, 2 GV LDX SSMO	Canon (9 H/5 HH)	2 Vizrt, 1 ChyronHego HyperX
	36HDX/VMU36	SXS dual feed: A 53' expando, B 53'	HD	Triax/SSMO fiber	Calrec Artemis (56/320)	9 GV LDX 80, 2 GV 6X SSMO	Canon (8 H/5 HH)	2 Vizrt, 1 ChyronHego HyperX
	37HDX/VMU37	SXS dual feed: A 53' expando, B 53'	HD	Triax/SSMO fiber	Calrec Artemis (56/320)	9 GV LDX 80, 2 GV 6X SSMO	Canon (8 H/5 HH)	2 Vizrt, 1 ChyronHego HyperX
	38FLEX/VMU38	SXS dual feed: A 53' expando, B 53'	HD/4K	Triax/SSMO fiber	Calrec Artemis (56/320)	7 GV LDX 80, 4 GV 6X SSMO	9 Canon hard, 2 Canon HH, 2 Fujinon HH	2 Vizrt, 1 ChyronHego HyperX
	39HDX/VMU39	53' double expando	HD/4K	SSMO fiber	Calrec Artemis (56/320)	12 Sony HDC-4300	Fujinon (8 H/4 HH)	1 ChyronHego HyperX, 1 ChyronHego Mosaic XL
	40HDX/VMU40	SxS dual feed: A 53' double expando, B 53'	HD	Triax/SSMO fiber	Calrec Artemis (56/320)	9 GV LDX 80, 2 GV 6X SSMO	1 Canon hard, 8 Fujinon hard, 4 Fujinon HH	2 Vizrt, 1 ChyronHego HyperX
MPS	MU-4	50' expando	SD 16:9	Triax	Yamaha PM4000 (52x8x2)	10 Sony	6 Canon hard, 4 Fujinon HH	ChyronHego HyperX2
	MU-5	53' expando	SD 16:9	Triax	SSL Axiom MT+ (192)	10 Sony	6 Fujinon HH, 5 Canon hard	ChyronHego HyperX3
	MU-6	53'	HD	Triax	Calrec	10 GV	Angenieux (6/4)	ChyronHego HyperX3
	MU-7	53' expando	SD 16:9	Triax	Yamaha PM4000	10 Ikegami	Fujinon (6/4)	ChyronHego HyperX2
NEP	Atlantic	49'5" expando	HD	Triax	Calrec Artemis Beam	10 Sony	Canon	As requested
	Arctic	55' expando	HD	Both	Calrec Q2			As requested
	California	62' expando	HD	Both	Calrec Apollo	16 Sony	As requested	As requested
	Chromium	53'	HD	Both	Calrec Apollo	18 Sony	Fujinon	As requested
	Cobalt	53' expando with hauler	HD	Fiber	Studer Vista	Sony, according to needs	Fujinon, according to needs	As requested
	EN1	58' expando twin with 3rd unit	HD/4K	Both	Calrec Apollo w/ Bluefin	16 Sony	15 Canon	As requested
	EN2	53' A and B unit	HD	Both	Calrec Apollo	16 Sony	Fujinon	As requested
	Gold	60' expando	SD	Both	Studer Vista 9	12 Sony	Fujinon	As requested
	Iridium	53'	HD	Both	Calrec Sigma	11 Sony	Canon	As requested
	M11HD	53' expando	HD	Both	Calrec Sigma w/ Bluefin (64/104 mono, 104 stereo)	10 Sony 1450	Fujinon (7H/3 HH), 1 wide-angle	ChyronHego HyperX3
	M12HD	53' expando	HD	Both	Calrec Artemis Beam w/ Bluefin2 and Hydra2 (64/104 mono, 104 stereo)	12 Sony 2570	Fujinon (10 H/3 HH), 2 wide-angle	ChyronHego HyperX3
	M14HD	53' expando	HD	Both	Calrec Artemis Beam w/ Bluefin2 and Hydra2 (64/104 mono, 104 stereo)	12 GV LDK 8000	Fujinon (7 H/ 3HH), 2 wide-angle	ChyronHego HyperX3
M3HD	SxS dual-feed: 48' expando	HD	Both	Yamaha 5000 (52/46 mono, 6 stereo)	3 GV LDK	Fujinon, Canon	ChyronHego HyperX3	

MICROPHONES	SWITCHER, M/E	NUMBER REPLAY DEVICES	ROUTER (VIDEO/AUDIO SIZE)
Senn., Sony, E-V,	GV Kalypso, 4M/E	2 6-ch. EVS XT2 LSM, 4-ch. XT2 LSM, 1 4-ch. XT2 RO, 2-ch. SpotBox, XFile3; P2 Deck, DVD	Leitch video (96x244), Euphonix audio (258x270)
Senn., Sony, E-V,	GV Kalypso, 4M/E	2 6-ch. EVS XT2 LSM, 2 4-ch. HD XT2 RO, 2-ch. SpotBox, XFile3; P2 Deck, DVD, GV K2 Dyno	Harris Platinum video (128x256), Euphonix audio (258x270)
Senn., Sony, E-V,	GV Kalypso, 4M/E	2 6-ch. EVS XT2 LSM, 4-ch. XT2 LSM, 1 4-ch. XT2 RO, 4-ch. SpotBox, XFile3; P2 Deck, DVD	GV video (128x256), Euphonix audio (258x270)
Senn., Sony, E-V,	GV Kalypso, 4M/E	2 6-ch. EVS XT2 LSM, 4-ch. XT2 LSM, 1 4-ch. XT2 RO, 2-ch. SpotBox, XFile3; P2 Deck, DVD	PESA video (128x256), Euphonix SH612 (792x792)
Senn., Sony, E-V,	GV Kayenne, 4.5M/E	2 6-ch. EVS XT2 LSM, 4-ch. XT2 LSM, 1 4-ch. XT2 RO, 4-ch. SpotBox, 1 XFile3; GV K2 Dyno; P2 Deck, DVD	PESA video (144x320), Euphonix SH612 (792x792)
Senn., Sony, E-V	GV Kayenne, 4.5M/E	1 12-ch. EVS XT3 LSM, 2 6-ch. XT3 LSM, 1 4-ch. XT3 RO, 2 XFile3, 4-ch. SpotBox; GV K2 Dyno; P2 Deck, DVD	GV video (160x352), Euphonix audio (258x270)
Senn., Sony, E-V	GV Kayenne, 4.5M/E	1 12-ch. EVS XT3 LSM, 2 6-ch. XT3 LSM, 1 4-ch. XT3 RO, 4-ch. SpotBox, 2 XFile3; GV K2 Dyno; P2 Deck, DVD	GV video (160x320), Euphonix audio (258x270)
Senn., Sony, E-V	GV Kayenne, 4.5M/E	3 12-ch. EVS XT3 LSM, 4-ch. SpotBox, 2 XFile3; P2 Deck, DVD	GV video (160x320), Euphonix audio (258x270)
Senn., Sony, E-V,	GV Kayenne, 4.5M/E	3 6-ch. EVS XT3 LSM, 2 4-ch. XT3 RO, 2 XFile3, 4-ch. SpotBox; GV K2 Dyno; P2 Deck, DVD	GV video (160x320), Calrec audio (192x192)
Senn., Sony, E-V,	GV Kayenne, 4.5M/E	3 6-ch. EVS XT3 LSM, 2 4-ch. XT3 RO, 4-ch. SpotBox, 2 XFile3; GV K2 Dyno; P2 Deck, DVD	GV video (160x320), Calrec audio (192x192)
Senn., Sony, E-V	GV Kayenne, 4.5M/E	1 12-ch. EVS XT3 LSM, 2 6-ch. XT3 LSM, 1 4-ch. XT3 RO, 4-ch. SpotBox, 2 XFile3; GV K2 Dyno; P2 Deck, DVD	GV video (160x320), Euphonix audio (258x270)
Senn., Sony, E-V	GV Kayenne, 4.5M/E	4 EVS, 1 12-ch. HD XT3 LSM, 2 6-ch. HD XT3 LSM, 1 4-ch. XT3 RO, 4-ch. SpotBox, GV K2 Dyno, 2 XFile3; P2 Deck, DVD	GV video (160x320), Euphonix audio (258x270)
Senn., Sony, E-V	GV Kayenne K-Frame	2 12-ch. EVS XT2 LSM, 1 6-ch. XT3 LSM, 1 4-ch. XT3 RO, 4-ch. SpotBox, 2 XFile3; GV K2 Dyno; P2 Deck, DVD	Evertz HD video (198x480), Evertz audio (1296x1456)
Senn., Sony, E-V	GV Kayenne K-Frame	1 12-ch. EVS XT3 LSM, 2 6-ch. XT3 LSM, 1 4-ch. XT3 RO, 4-ch. SpotBox, 2 XFile3; GV K2 Dyno; P2 Deck, DVD	Evertz HD video (230x256), Evertz EMR audio
Senn., Sony, E-V	GV Kayenne K-Frame	1 12-ch. EVS XT3 LSM, 2 6-ch. XT3 LSM, 1 4-ch. XT3 RO, 4-ch. SpotBox, 2 XFile3; GV K2 Dyno; P2 Deck, DVD	Evertz HD video (230x256), Evertz EMR audio
Senn., Sony, E-V,	GV Kayenne K-Frame	1 12-ch. EVS XT3 LSM, 2 6-ch. XT3 LSM, 1 4-ch. XT3 RO, 4-ch. SpotBox, 2 XFile3; GV K2 Dyno; P2 Deck, DVD	Evertz HD video (230x256), Evertz EMR audio
Senn., Sony	GV Kayenne K-Frame	2 12-ch. EVS XT3 LSM, 2 6-ch. XT3 LSM, 1 4-ch. XT3 RO, 4-ch. SpotBox, 2 XFile3; P2 Deck, DVD	Evertz HD video (230x256), Evertz EMR audio
Senn., Sony	GV Kayenne K-Frame	4 12-ch. EVS XT3 LSM, 4-ch. SpotBox, 2 XFile3; P2 Deck, DVD	GV NVision (477x862), GV NVision audio
Senn.	GV Kayenne K-Frame	3 12-ch. XT3 LSM, 4-ch. SpotBox, 1 XFile3; DVD	Evertz HD video (576x828), Evertz EMR audio
Senn.	GV Kayenne K-Frame	4 12-ch. EVS XT3 LSM, 4-ch. SpotBox, 2 XFile3; P2 Deck	Evertz HD video (378x802), Evertz EMR audio
E-V, Sony, Shure, Senn., Rohde	GV Kalypso, 4M/E	6-ch. EVS XT, 4-ch. XT2, XFile; 4 DigiBeta, 2 BetaSP, FFV	GV Kalypso
E-V, Sony, Shure, Senn., Rohde	GV Kalypso, 4M/E	2 6-ch. EVS XT, XFile; 4 DigiBeta, 2 Beta SP, FFV	GV Kalypso
E-V, Sony, Shure, Senn., Rohde	GV Kalypso, 4M/E	2 4-ch., 1 6-ch., XFile, SpotBox; DVCam, DVCPRO	PESA
E-V, Sony, Shure, Senn., Rohde	GV Kalypso, 4M/E	1 6-ch., 1 4-ch., Xfile; 2 DigiBeta, FFV	PESA
Senn., E-V,	GV Karrera, 2.5M/E	2 6-ch. EVS XT2, 4-ch. XT2 RO, K2 SpotBox, SportNet Hub, XFile2; 1 XDCam, 1 HDCam	160x288 video, 96x96 mono analog audio, 192x192 AES audio
Senn., E-V, Shure, Sanken			
Senn., Sony, E-V, Shure	GV Kayenne K-Frame	Up to 16 VTRs and 5 servers as requested	GV Trinx (256x448 HD/SD), GV SMS-7000 audio (64x64x4)
Senn., Shure, Sony	GV Kayenne K-Frame	4 6-ch. EVS XT3 LSM, 1 6-ch. XT3 SpotBox, 2 XHub, Xfile; A500; DigiBeta	Evertz EQX 3G HD (128x112) routing
Shure, Senn.	GV Kayenne	HD/SD options	GV NVision HD-SDI 3-Gb-capable multiformat (576x576), Nvision 96-port RS422
Senn., Sony, E-V, Shure	GV Kayenne K-Frame switcher, 4M/E	9 6-ch. EVS XT3, 6-ch. SpotBox, Sport Net HUB, XFile2, XTAccess, EVS SQL Database Server; 1 DVCPRO	Evertz EQX with integrated multiviewers (576x650/288/325 embedded, 192x192 mono analog audio, 192x192 AES, 4x4 dual-channel MADI)
Senn., Studio Tech, E-V	GV Kayenne K-Frame	8 8-ch EVS XT3 LSM, 6-ch XT3 SpotBox, 3 SportNet Hub, Xfile	
Senn., Sony, E-V, Shure	Sony MVS-8000X	Up to 16 VTRs as requested	As requested
Senn., Shure	GV Kayenne K-Frame	5 6-ch. EVS XT3, 1 4-ch XT3 SpotBox, 2 XHub, Xfile; M2000, A500, XDCam	
Senn., Beyer, Shure, Sony	GV Kalypso, 4M/E	2 6-ch. EVS XT2, 2 4-ch. RO XT2, SpotBox, XFile; DigiBeta	288x576 HD/128x128 AES, 128x128 stereo audio
Senn., Beyer, Shure, Sony	GV Kayenne, 4.5 M/E	2 6-ch. EVS XT3, 1 6-ch. RO XT3, 1 4-ch. RO XT3, SpotBox, Xfile	334x462 HD/96x96 AES, 48x96 stereo
Senn., Beyer, Shure, Sony	GV Kayenne K-Frame, 4.5M/E	2 6-ch. EVS XT3, 2 4-ch. RO XT3, SpotBox, XFile; XDCam, 1 SxS recorder/player	334x476 HD/96x96 AES, 48x96 stereo
Senn., E-V, Sony	GV Kalypso, 4M/E	6-ch. EVS XT2, 4-ch. RO XT2, 4-ch. SpotBox, XFile; DigiBeta	96x96 HD, 128X128 SD

# THE BUSIEST MOBILE FACILITIES PROVIDER YOU'VE NEVER HEARD OF...



**CONSTELLATION** DUAL PATH Ku UPLINK + CAMERAS: HD.  
**Switcher** 2ME HD Sony 8000. **Multiviewers** 2 Evertz VIP. **Cameras** Up to 4 +  
 POV & Robo. **Intercom** RTS Matrix. **Audio Mix** Soundcraft Digital 24 Input.  
**Audio Record** Video Devices PIX270. **Video Record** 6 AJA KiPro Racks.  
**Seats** 6.



**ORIGINATION** SMALL FOOTPRINT, FULLY LOADED: HD.  
**Switcher** 2ME HD Ross Carbonite. **Multiviewers** 2. **Cameras** Up to 8 + POV &  
 Robo. **Intercom** RTS Matrix. **Audio Mix** Soundcraft Digital 48 Input.  
**Audio Record** Video Devices PIX270. **Video Record** 10 AJA KiPro Racks  
**Seats** 8.



**BLACKJACK** SMALL FOOTPRINT, FULLY LOADED: HD or 4K UHD.  
**Switcher** 2.5ME HD Ross Carbonite. **Multiviewers** 2. **Cameras** Up to 8 +  
 POV & Robo. **Intercom** RTS Matrix. **Audio Mix** Mackie Analog 24 Input.  
**Audio Record** JoeCo BBR. **Video Record** 8 AJA KiPro Racks.  
**Seats** 8.



**ELEVATION** MEDIUM FOOTPRINT, FULLY LOADED: HD.  
**Switcher** 3ME HD Ross Vision. **Multiviewers** 8. **Cameras** Up to 10 + POV &  
 Robo. **Intercom** RTS Matrix. **Audio Mix** Soundcraft Digital 64 Input.  
**Audio Record** ProTools + Video Devices PIX270. **Video Record** 12 AJA KiPro  
 Racks. **Seats** 10.



**INSPIRATION** MEDIUM FOOTPRINT, FULLY LOADED: HD.  
**Switcher** 2ME HD Ross Vision. **Multiviewers** 4. **Cameras** Up to 10 + POV &  
 Robo. **Intercom** RTS Matrix. **Audio Mix** Soundcraft Digital 64 Input.  
**Audio Record** ProTools + Video Devices PIX270. **Video Record** 12 AJA KiPro  
 Racks. **Seats** 10.

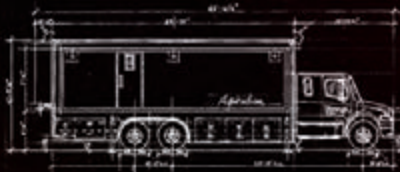

**ASPIRATION** EXPANDING SIDE, FULLY LOADED: HD.  
**Switcher** 3ME HD Sony 8000. **Multiviewers** 8. **Cameras** Up to 12 + POV &  
 Robo. **Intercom** RTS Matrix. **Audio Mix** Soundcraft Digital 96 Input. **Audio**  
**Record** ProTools + Video Devices PIX270. **Video Record** 16 AJA KiPro  
 Racks. **Seats** 14.

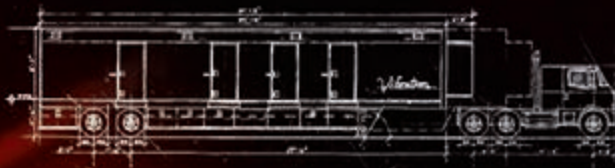

**VIBRATION** LARGE AUDIO MIX + CAMERAS: HD.  
**Audio Mix** Studer Vista 9 Digital 256 Input. 5.1 / 7.1 Capable.  
**Audio Record** ProTools + JoeCo BBR (all 256 inputs) **Switcher** 2ME HD  
 FOR-A HVS-390. **Multiviewers** 2. **Cameras** Up to 4 + POV & Robo.  
**Intercom** RTS Matrix. **Video Record** 8 AJA KiPro Racks.  
**Seats** 5 + Client Lounge.

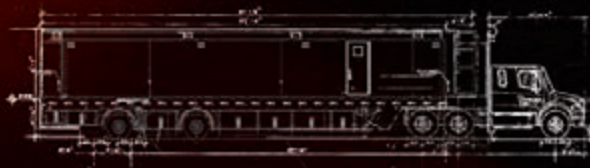

**EXCLAMATION** DOUBLE EXPANDING SIDE: HD or 4K UHD.  
**Switcher** 4ME GVG Kayenne with Double Take. **Multiviewers** 24.  
**Cameras** Up to 24 + POV & Robo. **Intercom** RTS Matrix. **Audio Mix** Studer  
 Vista X Digital 256 Input. **Audio Record** ProTools + Video Devices PIX270.  
**Video Record** 26 AJA KiPro Racks. **Seats** 30.



**GEARHOUSE BROADCAST**

# **NEW 4K SUPERTRUCK AVAILABLE FOR USE IN THE USA**

**DESIGNED FOR THE AMERICAN  
LIVE PRODUCTION MARKET**

- 4K AND HD
- STATE OF THE ART
- HIGHLY FLEXIBLE
- 50' HYDRAULIC MAST
- 2 CONTROL ROOMS
- 22 4K/HD CAMERAS  
INCLUDING 6 RF  
CAMERAS



COMPANY	TRUCK NAME	DIMENSIONS/ TYPE	SD/HD/1080P/ 4K-CAPABLE	TRIAx, FIBER, OR BOTH?	AUDIO CONSOLE (FADERS/CHANNELS)	# CAMERAS & MAKE	LENSES (H/HH)	GRAPHICS
NEP	M4HD	53' expando	HD	Both	Calrec Omega w/ Bluefin (56/64 mono, 48 stereo)	8 Sony 1450	Canon (6 H/3 HH)	ChyronHego HyperX3
	M5HD	53' expando	HD	Both	Calrec Omega w/ Bluefin (56/64 mono, 48 stereo)	16 cameras	Fujinon (6 H/3 HH), 2 wide-angle	ChyronHego HyperX3
	M6HD	53' expando	HD	Both	Yamaha 5000 (52/46 mono, 6 stereo)	10 cameras	Fujinon (5 H/2 HH), 1 wide-angle	ChyronHego HyperX3
	M7HD	53' expando	HD	Both	Calrec Sigma w/ Bluefin (64/104 mono, 104 stereo)	16 cameras	Fujinon (7H/3HH+2 wide angle)	ChyronHego HyperX3.1
	M8HD	48' expando	HD	Both	Calrec Omega w/ Bluefin (56/64 mono, 48 stereo)	10 cameras	Fujinon (5 H/3 HH)	ChyronHego HyperX3
	M9HD	53' expando	HD	Both	Calrec Sigma w/ Bluefin (64/104 mono, 104 stereo)	16 cameras	Fujinon (7 H/3 HH), 2 wide-angle	ChyronHego HyperX3
	NCPH	53' expando	HD	Both	Calrec Artemis Beam	9 Thompson	12 Canon	As requested
	NCPHIV	53' expando	HD	Both	Calrec Sigma w/ Bluefin (72)	13 Ikegami, 1 Panasonic	13 Canon	As requested
	NCPHVI	53' expando	HD	Triax	Calrec Alpha (96)	12 Sony	16 Canon	As requested
	NCPHVIII	53' expando	HD	Both	Calrec Alpha w/ Bluefin (96)	12 Ikegami, 1 Sony	9 Canon	As requested
	NCPHX	53' expando	HD	Triax	Calrec Alpha w/ Bluefin (96)	12 Ikegami, 1 Panasonic	18 Canon	As requested
	NCPHXI	53' expando	HD	Both	Calrec Sigma w/ Bluefin (72)	12 Ikegami	11 Canon	As requested
	NCPHXIV	53' expando	HD	Both	Calrec Sigma w/ Bluefin (72)	10 Sony	18 Canon	As requested
	ND1	3 53' expandos	HD, Yes	Both	Calrec Apollo	17 Sony	20 Canon	As requested
	ND2	53' expando	HD	Both	Calrec Q2 (120)	GV LDK	10 Canon	As requested
	ND4/Double Eagle	53' expando twin	HD	Both	Calrec Alpha w/ Bluefin (86)	24 Sony	16 Canon	As requested
	ND5	53' expando	HD	Both	Calrec Artemis Beam w/ Bluefin (64)	11 Sony, 1 Sony SSM	14 Canon	As requested
	ND6	60' expando	HD	Both	Calrec Artemis Beam w/ Bluefin (64)	11 Sony, 1 Sony SSM	15 Canon	As requested
	ND7	53' expando	HD	Both	Calrec Apollo w/ Bluefin	12 Sony	14 Canon	As requested
	Pacific	A: 47', B: 40'	HD	Fiber	2 Yamaha DM2000	Sony, according to needs	Fujinon, according to needs	As requested
	Phoenix	53' expando	HD	Triax	Calrec Sigma	11 GV	10 Fujinon	As requested
	Platinum	53'	HD	Both	Calrec Alpha	11 Sony	Fujinon	As requested
	Rhythm	53' expando	HD	Triax	Calrec Sigma w/ Bluefin	10 GV	10 Fujinon	As requested
	Sapphire	40' expando	HD	Fiber	Yamaha DM2000	Sony, according to needs	Fujinon, according to needs	As requested
	Silver	53' expando	HD	Both	Calrec Alpha (72 faders)	16 Sony	2 Canon, 9 Fujinon	As requested
	Skyline	53' expando	HD	Both	Calrec Sigma w/ Bluefin	10 GV	11 Canon	As requested
	SS1		HD	Both	Calrec Alpha	12 Sony	Canon	As requested
	SS10	53' expando	HD	Both	Calrec Alpha w/ Bluefin (96)	19 Sony, 2 Sony clock cam, 1 Sony SSM	28 Fujinon	As requested
	SS11	53' expando	HD	Both	Calrec Omega w/ Bluefin (64)	10 Ikegami	13 Canon	As requested
	SS14	53' expando	HD	Triax	Calrec Alpha (60)	10 GV	11 Fujinon	As requested
	SS15	53' expando	HD	Both	Calrec Sigma w/ Bluefin (64)	12 Sony	9 Canon, 2 Fujinon	As requested
	SS16	53' expando w/ B unit	HD	Both	Calrec Sigma w/ Bluefin (64)	10 Sony	11 Canon	As requested
SS17	55' expando w/o tractor	HD	Both	Calrec Sigma w/ Bluefin (64)	10 Sony	11 Canon	As requested	
SS18	56' expando w/o tractor	HD	Triax	Calrec Sigma w/ Bluefin (60)	11 Sony	11 Canon	As requested	
SS20	53' expando	HD	Both	Calrec Sigma w/ Bluefin (60)	12 Sony	10 Canon, 2 Fujinon	As requested	



MICROPHONES	SWITCHER, M/E	NUMBER REPLAY DEVICES	ROUTER (VIDEO/AUDIO SIZE)
Senn., Beyer, E-V, Shure, Sony	GV Kalypso, 4M/E	6-ch. EVS XT2, 4-ch. XT2, 4-ch. RO XT2, SpotBox, XFile; DigiBeta	96x96 HD, 128x128 SD, 96x96 audio
Senn., E-V, Sony	GV Kalypso, 4M/E	6-ch. EVS XT2+, 4-ch. XT2+, 6-ch. RO XT 2+, SpotBox, XFile; DigiBeta	288x512 HD, 256x256 SD/256x256 audio
Senn., A-T, Sony, E-V	GV Kalypso, 4M/E	6-ch. EVS XT3, 2 4-ch. RO XT2+, SpotBox, XFile; DigiBeta	192x288 HD/64x64 audio
Senn., Beyer, Shure, Sony	GV Kayenne K-Frame	6-ch. EVS XT2, 4-ch. XT2, 2 4-ch. RO XT2, SpotBox, XFile; XDCAM, HDCAM, DigiBeta	288x576 HD, 128x128 AES audio, 128x128 stereo audio
Senn., Shure, Sony	GV Kalypso, 4M/E	6-ch. EVS XT2, 4-ch. RO XT2, SpotBox, 2-ch. HD FFWD, XFile; DigiBeta	192x304 HD/128x128 AES, 128x128 stereo
Senn., Beyer, Shure, Sony	GV Kayenne, 4.5M/E	2 6-ch. EVS XT2, 2 4-ch. RO XT2, SpotBox, XFile; DigiBeta	288x576 HD/128x128 AES, 128x128 stereo
Senn., Sony, E-V, Shure	GV Kalypso, 4M/E	2 6-ch. EVS XT2, 2 4-ch. XT2 RO, 4-ch. SpotBox, 2 SportNet Hub, XFile; 2 M2000 HDCAM, XDCAM, 2 DigiBeta	Utah Scientific 400 (384x624 HD, 48 Inputs demux 16-ch. each, 84 outputs mux 16-ch. Each; Utah Scientific 400 2,304 ch. TDM (128x128 analog, 128x128 AES, 768x1,344)
Senn., Sony, E-V, Shure	GV Kalypso, 4M/E	2 6-ch. EVS XT2, XT, 2 6-ch. RO XT2, XT2, SpotBox; 2 DigiBeta, BetaSP, DVCPRO, Multicam 10	Utah Scientific 400 (228x456 HD, 288x288 SDI), Utah Scientific 400 (80x120 analog, 208x168 AES)
Senn., Sony, E-V, Shure	GV Kayenne	2 6-ch. EVS XT2, 3 4-ch. RO XT2, SpotBox; 2 HD DVCPRO, HDCAM, 2 DigiBeta, Multicam 10	Utah Scientific HD (288x528), 208x208 AES, 96x96 analog
Senn., Sony, E-V, Shure	GV Kayenne K-Frame	4 6-ch. EVS XT3, XT3 SpotBox, XFile; M2000, DVCPRO, PDW, XDCam	HD video (288x528), audio (128 AES, 44 analog x 128 AES, 128 analog)
Senn., Sony, E-V, Shure	GV Kayenne K-Frame	6 6-ch. EVS XT3, 1 XT3 SpotBox, 3 SportNet Hub, XFile; HDCam, DVCPRO, A500	Utah Scientific 400 (288x705 HD), audio (128 AES, 128 analog x 128 AES, 128 analog)
Senn., Sony, E-V, Shure	GV Kayenne	2 6-ch. EVS XT2, 3 4-ch. RO XT2, SpotBox; DVCPRO, 2 DigiBeta, Multicam 10	Utah Scientific 400 (288x552), Utah Scientific 400 (216x184 AES, 72x104 analog)
Senn., Sony, E-V, Shure	GV Kayenne	2 6-ch. EVS XT2, 2 6-ch. RO XT2, XT2 SpotBox; 2 HDCAM, XDCAM, DigiBeta, Multicam 10	Utah Scientific 400/528 (288x528), Utah Scientific 400/288R (192x192 MADI, 96x39 AES, 24x55 analog)
Senn., Shure, Sony	GV Kayenne K-Frame	10 6-ch. EVS XT3, 1 6-ch. SpotBox, XFile2 transfer, 2 IPDirector, 5 SportNet Hub, HDCam, SRW, XDCam	Evertz EQX with integrated multiviewers (576x540/288x288 embedded, 92x192 mono analog, 192x192 AES, 36x36 dual-channel MADI)
Senn., Sony, E-V, Shure, Sanken	GV Kalypso, 4M/E	Wired for 8 VTR and 4 EVS as requested	PESA (144x128 HD-SDI), PESA Tiger audio (144x144 stereo)
Senn., Sony, E-V, Shure	GV Kayenne K-Frame	10 6-ch. EVS XT2, SpotBox	GV Trinx HD video (256x256), GV Concerto audio (192x192 analog stereo, 512x768 AES)
Senn., Sony, E-V, Shure	GV Kalypso, 3.5M/E	6 6-ch. EVS XT3 LSM, XT2 SpotBox, IPDirector, 2 XFile2; Sony HDCAM, 2 Sony XDCAM, DigiBeta	PESA HD (270x240 with 16-ch. embed/de-embed capabilities, PESA distributed audio (512x640 AES, 128x128 analog, 512x512 MADI, 96x96 embedded)
Senn., Sony, E-V, Shure	GV Kayenne K-Frame	6 6-ch. EVS XT3 LSM, XT2, SpotBox, IPDirector, 2 EVS, XF2; GiGE Jumboframe network; Sony HDCAM, 2 Sony XDCAM, DigiBeta	PESA HD (270x240 w/16 ch. embed/de-embed capabilities), PESA distributed audio (512x640 AES, 128x128 analog, 256x256 MADI, 96x96 embedded)
Senn., Sony	GV Kayenne K-Frame	6-ch. EVS XT3, XT3 SpotBox, IPDirector, XFile3 4 SportsNet HUB	PESA HD (640x874), PESA DRS audio
Shure, Senn	GV Kayak, 2.5M/E	HD/SD options	GV Concerto video (128x128 HD/SD), GV Venus audio (128x128 analog)
Senn., Sony	GV Kalypso, 4M/E	2 6-ch. EVS XT2 LSM, 4-ch. XT2 LSM, 4-ch. RO XT2, 4-ch. SpotBox, wired for 1 more EVS; GV K2 Dyno; HDW, XDCAM, DigiBeta	Miranda FR 8280 video (162x270 HD), GV Concerto audio (128x128 AES, 128x128 analog)
Senn., Shure, Sony	GV Kalypso	2 6-ch. EVS XT2, 4-ch. XT2, 4-ch. XT2 RO, SpotBox, XHub, XFile	GV Nvision
Senn., Sony	GV Kalypso, 4M/E	6-ch. EVS XT2 LSM, 4-ch. XT2 LSM, 4-ch. RO XT2, 4-ch. XT2 SpotBox, wiring for 2 more EVS; HDW, XDCAM, DWW	GV Trinx video (160x224 HD/SD), GV Concerto audio (128x128 AES, 96x96 analog)
Shure, Senn.	Sony, 1.5M/E	HD/SD options	GV Concerto (96x96 HD/SD)
As requested	GV Kalypso	As requested	GV Trinx video (256x352 HD/SD), GV Apex audio (672/672 AES, MADI, analog)
Senn., Beyer, E-V, Shure, Sony	GV Kalypso, 4M/E	3 6-ch. EVS, 1 4-ch. SpotBox, SportNet Hub, HDW, DigiBeta, XDCam	PESA Cheetah video (144x256), PESA DRS AES (384x384), PESA DRS analog (256x256), PESA MADI (4x4)
Senn., Sony	GV Kayenne	1 K2 Summit, 2 SRW, 3 6-ch. EVS XT2, 2 4-ch. XT2, XFile, SpotBox	
Senn., Sony, E-V, Shure	GV Kayenne K-Frame	6 6-ch. EVS XT2, 1 4-ch. SpotBox, 2 IPDirector, SportNet Hub, SpotBox; HDCam, DVCPRO, DigiBeta	PESA Cheetah/DRS (1,072x1,344 HD/1472x1,728 audio, 128x128 AES, 128x128 analog, MADI)
Senn., Sony, E-V, Shure	GV Kalypso, 4M/E	3 6-ch. EVS XT2, 4-ch. RO XT2, XT2, SpotBox, SportNet Hub; 2 DigiBeta, 3 HDCAM SRW, 2 DVCPRO, DigiBeta, DVCPRO, 2 HDCAM	GV Concerto video (128x128 HD-SDI), 512x512 TDM audio (192 analog, 320 AES, analog and AES internal crossconversion capability)
Senn., Sony, E-V, Shure	GV Kalypso, 4M/E	2 6-ch. EVS XT2, 2 4-ch. XT2, SpotBox, SportNet Hub; DigiBeta, 2 HDCAM	GV (96x96 HD/256x256 AES and analog)
Senn., Sony, E-V, Shure	GV Kalypso, 4M/E	4 6-ch. EVS XT2, 4-ch. XT2, SpotBox, SportNet Hub; DigiBeta, 2 DVCPRO, HDCAM, SRW, DigiBeta	GV video (256x192 HD), GV AES (384x384), GV analog (128x128), GV MADI (192x320)
Senn., Sony, E-V, Shure	GV Kayenne	Wiring to support 7 EVS frames and 4 VTRs; 1 6-ch. EVS XT3 SpotBox, 4 6-ch. XT3, 2 SportNet Hub for LSM and SpotBox, 1 XFile3, 1 IPDirector; 1 Sony SRW-5500 VTR; 1 Sony HDCAM HDW-1800; 1 Panasonic DVCPRO AJHD-1700	PESA video (192x192 HD/SD-SDI), PESA DRS AES (512x640), PESA DRS analog (128x128), PESA DRS MADI (128x128), 96x96 embed/de-embed 16 ch.
Senn., Sony, E-V, Shure	GV Kalypso Duo, 4M/E	3 6-ch. EVS XT2, 2 4-ch. XT2, SpotBox; DigiBeta, 5 HDCAM, HDCAM SRW	PESA video router w/ 16 channel embed/de-embed capabilities, PESA DRS 512x640 AES audio router, PESA DRS 128x128 analog audio router, PESA DRS 128x128 MADI audio router, 96x96 embed/de-embed, 16 channels
Senn., Sony, E-V, Shure	GV Kayenne K-Frame	4 6-ch. EVS XT2, SpotBox, SportNet Hub; HDCAM SRW, DigiBeta	GV Trinx Concerto (160x128 HD/SD), GV Apex (576x576 AES, 128x128 analog)
Senn., Sony, E-V, Shure	GV Kalypso, 4M/E	5 6-ch. EVS XT2, 4-ch. XT2, SpotBox, 2 SportNet Hub; DigiBeta, DVCPRO, HDCAM, SRW, DigiBeta	176x176 HD-SDI video router with 96 embedders and 96 de-embedders, 128x128 analog audio router (mono) with 96 de-embedding inputs and 96 embedding outputs, 256x256 MADI, 512x640 AES



# Mobile TV Group

PRODUCTION INNOVATION FOR THE  
TOP CONTENT CREATORS IN THE U.S.

HD | 4K | UHD | HDR



TEAMWORK. RELIABILITY. TRUST.



MobileTVGroup.com



**EVERY SPORT HAS A DEFINING MOMENT.**

An instant of true innovation. A turning point that sets a new standard of play. For the sports broadcast industry, the launch of **ProCrewz 2.0** is that moment.

**PROCREWZ IS THE PREMIER DATA MANAGEMENT TECHNOLOGY PLATFORM**

designed specifically for the live-event and broadcast television industries. Reliable, for those who depend on data; instant, for those who don't have time to wait; and customized just for your business; **ProCrewz Data Management System is changing the game.**



**PASSION FROM EVERY ANGLE.**

COMPANY	TRUCK NAME	DIMENSIONS/ TYPE	SD/HD/1080P/ 4K-CAPABLE	TRIAx, FIBER, OR BOTH?	AUDIO CONSOLE (FADERS/CHANNELS)	# CAMERAS & MAKE	LENSES (H/HH)	GRAPHICS
NEP	SS22	53' expando w/ B unit	HD	Both	Calrec Apollo w/ Bluefin	12 Sony	13 Canon	As requested
	SS23	53' expando w/ B unit	HD	Triax	Calrec Alpha (64)	13 Ikegami	13 Fujinon	As requested
	SS24	53' expando twin	HD	Both	Calrec Alpha w/ Bluefin (86)	15 Sony	17 Canon	As requested
	SS25	53' expando twin w/ carry-all truck	HD	Both	Calrec Alpha w/ Bluefin (86)	12 Sony	12 Canon, 2 Fujinon	As requested
	SS28	53' expando w/ B unit	HD	Triax	Calrec Sigma w/ Bluefin (64)	11 GV	Canon, Fujinon	As requested
	SS29	53' expando twin	HD	Both	Calrec Artemis (64)	12 Sony	13 Canon	As requested
	SS3	53' expando or flypack	HD	Both	DIGiCo SD10B	GV LDK 6000	8 Canon	As requested
	SS32	53' expando	HD/4K	Both	Calrec Alpha w/ Bluefin (72)	10 Sony	As requested	As requested
	SSCBS	3 53' trailers	HD	Both	Calrec Apollo	Sony	Fujinon, Canon	As requested
	Summit	53' expando twin	HD	Both	Calrec Alpha w/ Bluefin (96)	24 Sony	2 Canon, up to 20 Fujinon	As requested
	Tango	53' expando	HD	Triax	Calrec Alpha	10 GV	12 Fujinon	Upon request
	Tempo	53' expando	HD	Triax	Calrec Omega	9 GV	10 Canon	As requested
	TS2	53' expando	HD	Both	Calrec Alpha	12 Sony	Canon	Upon request
	XP-1	Sprinter van	HD	Both	Yamaha	5 GV	Canon	As requested
	PROSHOW BROADCAST	Maestro	40' Gerling Super Stallion expando	HD	Triax/fiber	Calrec Omega (40/112)	6-12 Sony	Canon, Fujinon86X
Prodigy		40' Gerling Stallion	HD	Triax/fiber	Yamaha M7 (48/48)	6-8 Sony	Canon, Fujinon (75X/55X)	ChyronHego HyperX3
Opus		27' Gerling Super Nomad/REMI	HD	Triax/fiber	Yamaha QL-5 (32/72)	6-8 Sony	Canon 76X	
Ovation		27' Gerling Super Nomad/REMI	HD	Triax/fiber	Yamaha QL-5 (32/72)	6-8 Sony	Canon 76X	
Busker		24' Mercedes Sprinter/REMI	HD	Triax	Soundcraft Expression (20/20)	4-5 Sony	Canon, Fujinon (76X/60X/50X)	
Solo		24' Mercedes Sprinter/REMI	HD	Triax	Soundcraft Expression (20/20)	4-5 Sony	Canon, Fujinon(72X/60X/50X)	
Trouper		24' Mercedes Sprinter/REMI	HD	Triax	Soundcraft Expression (20/20)	4-5 Sony	Canon, Fujinon (72X/60X/50X)	
PSSI	K34	A unit: 36', B unit: 35'	HD	Triax	Yamaha M7CL (48 Analog Inputs/24 Configurable Outputs)	6 GV 3000	4 Fujinon hard, 5 Canon HH	ChyronHego HyperX3
RAYCOM SPORTS	HD1	53' expando	HD	Both	Calrec Omega w/Bluefin 2 (48)	9 Sony	Canon (6 H/4 HH)	ChyronHego HyperX3
	HD2	53' expando	HD	Triax	Calrec Artemis Light w/Bluefin 2 (56)	9 Sony	Canon (6 H/4 HH)	ChyronHego HyperX3
	RKU2	27" combo	HD	Fiber	Mackie (32 ch.)	4 Hitachi	Fujinon (2 H/2 HH)	Ross XPression
ROSS MOBILE PRODUCTIONS	Silver	23' Sprinter	HD	Triax	Soundcraft Expression 3 (30 faders/64 analog inputs/24 analog outputs/18 AES inputs/34 AES outputs )	6 Ikegami HDK-95C	Canon: 2 60X, 2 40X, 2 22X	1 Ross XPression, 1 Ross XPression (TD Elements)
	Blizzard	20'	HD	Both	DigiCo SD11B w/D-Rack (80 ch.)	5 Hitachi SK-HD1300	Fujinon: 1 70X, 1 36X, 3 20X	1 Ross XPression, 1 Ross XPression GO! (TD Elements)
	FIN3	24' Sprinter	HD	Both	Soundcraft Expression 3 (30 faders, 64 analog inputs/24 analog outputs/18 AES inputs/34 AES outputs )	6 Ikegami HDK-95C	Canon: 2 60X, 1 80X, 2 22X, 1 10X	1 Ross XPression, 1 Ross XPression (TD Elements), 1 Ross XPression GO!
	FIN4	24' Sprinter	HD	Both	Soundcraft Expression 3 (30 faders, 64 analog inputs/24 analog outputs/18 AES inputs/34 AES outputs )	6 Ikegami HDK-95C	Canon: 2 60X, 1 80X, 2 22X, 1 10X	1 Ross XPression (GFX), 1 Ross XPression (TD Elements), 1 Ross XPression GO!
	FIN5	24' Sprinter	HD	Both	Soundcraft Expression 3 (30 faders, 64 analog inputs/24 analog outputs/18 AES inputs/34 AES outputs )	6 Ikegami HC-HDK95C	Canon: 2 60X, 1 95X, 2 22X, 1 10X	1 Ross XPression, 1 Ross XPression (TD Elements), 1 Ross XPression GO!
SDTV	ExpandoLink	40' combo/ expando	SD	Triax	Allen & Heath ML4000 (40)	8 Sony	8 Canon	ChyronHego Duet HyperX2

MICROPHONES	SWITCHER, M/E	NUMBER REPLAY DEVICES	ROUTER (VIDEO/AUDIO SIZE)
As requested	GV Kayenne K-Frame	5 6-ch. EVS XT3 LSM, 1 4-ch. XS SpotBox; 1 IPDirector, 3 SportNet Hub, 1 XFile3; 1 Sony HDW-500 HDCam VTRs 1080i Only, 1 DWW-A500 DigiBeta VTR; 1 Panasonic AJHD-1800 DVCPRO VTR	PESA video (192x176 HD, 96 16-ch. MUX/DMUX I/O capable), PESA AES (384x384), PESA analog (192x192), PESA mux/dux (1536x1536)
Senn., Sony, E-V	GV Kalypso, 4M/E	2 6-ch. EVS XT2, 2 4-ch. RO XT2, SpotBox, SportNet Hub; 2 DVCPRO, HDCAM, 2 DigiBeta	GV Trinx 448x512 HD video router, GV Trinx 256x256 AES router
Senn., Sony, E-V, Shure	GV Kayenne K-Frame	Wired to support 3 EVS IPDirector, 13 EVS, 1 SpotBox, and 6 VTR; 1 6-ch. XT3 SpotBox, 6 6-ch. XT3 LSM, 3 SportNet XHub3, 2 XFile3; 2 Sony HDW-500 HDCam VTRs, 1 SRW-5500 HDCam/HDCam SR, 1 DWW-A500 DigiBeta VTR	GV Trinx video (256x256 HD), GV Apex audio (192x192 analog stereo, 448x448 AES)
Senn., Sony, E-V, Shure	GV Kalypso Duo	6 4-ch. EVS XT2, XT2, 3 6-ch. XT2, SpotBox, SportNet Hub; DigiBeta, 2 DVCPRO	172x160 HD-SDI video, 224x416 SD monitor, 32x32 analog stereo, 224x224 AES, analog and AES, internal crossconversion capability
Senn., Sony, E-V, Shure	GV Kalypso, 4M/E	2 6-ch. EVS XT2, 3 4-ch. XT2, SpotBox; 2 DigiBeta, DVCPRO, HDCAM	GV Trinx (160x128 HD), GV Trinx (256x256 SD), GV Concerto (256x256 AES mono), GV Concerto (256x256 analog)
Senn., Sony, E-V, Shure	GV Kayenne, 4M/E	3 6-ch. EVS XT2, 2 6-ch. RO XT2, SpotBox, SportNet Hub; DigiBeta, 2 DVCPRO	GV Trinx (288x480 HD)
As requested	Sony	1 GV K2 Solo, 2 K2 Dyno Summit	PESA (48x112 HD-SDI, with 16x16 embedded), external SD rack with 40x40 analog and 8x8 AES, MADI I/O to router, PESA (64x64 AES, D>A and A>D conversion)
As requested	GV Kayenne Elite, 9M/E	5 6-ch. EVS XT3, 6-ch. XT3 SpotBox; 2 SRW, DVCPRO, 2 Blu-ray	Evertz EQX with integrated multiviewers (378x146, plus monitoring outputs/192x192 mono audio, 192x192 AES, 4x4 MADI)
Audio Tech, Senn	GV Kayenne Elite	2 12-ch. EVS XT3 LSM, 4 8-ch. XT3 LSM, 1 6-ch. XT3 SpotBox, 5 XHub3 for EVS LSM/SpotBox, 1 XFile3, 4 IPDirector, 2 XT/Access	
Senn., Sony, E-V, Shure	GV Kayenne K-Frame	20 VTRs or 7 EVS on request, 2 SpotBox	GV Trinx (192x160 HD under Encore control), GV Apex (544x544 AES, 128x128 2-ch. Analog)
Senn., Sony	GV Kalypso, 4M/E	2 6-ch. EVS XT2 LSM, 4-ch. RO XT2, 4-ch. XT2 LSM, 4-ch. XT2, SpotBox, wiring for one more EVS; HDW, 2 DigiBeta	GV Trinx (256x256 HD/SD), GV Concerto (192x192 AES, 128x128 analog)
Senn., Sony	GV Kalypso, 4M/E	6-ch. EVS XT2 LSM, 4-ch. XT2 LSM, 4-ch. RO XT2, 4-ch. XT2, SpotBox, wiring for 1 more EVS; HDW, XDCAM, 2 DigiBeta	GV Trinx (128x256 HD), GV TC 64-port machine-control router (32x32), GV Concerto (128x128 AES, 96x96 analog)
Senn.	GV Kayenne K-Frame	1 4-ch. GV K2 Summit; 2 Sony SRW-5000 recorders, 1 HDW-M2000 HDCAM; 5 EVS LSM XT3, 1 XFile2, 1 4-ch. XS SpotBox	
Senn.	FOR-A MVS-1000	1 4-ch. EVS XT; others as requested	
Senn., Sony, E-V	GV Kalypso, 4M/E	2 EVS XT3 XFile3; HDCAM, DVCPROHD	128X128 video, 128X128 audio, 72X144 video mon.
Senn., Sony, E-V	Sony MVS-8000 2.5 M/E	2 EVS XT3 XFile3; Hyperdeck	64X64 video, 64X64 audio, 72X144 video mon.
Senn., Sony, E-V	Blackmagic ATEM	Wired for 6-ch.	72/72 video
Senn., Sony, E-V	Blackmagic ATEM	Wired for 6-ch.	72/72 video
Senn., Sony, E-V	Blackmagic ATEM	Wired for 6-ch.	40X40 video
Senn., Sony, E-V	Blackmagic ATEM	Wired for 6-ch.	40X40 video
Senn., Sony, E-V	Blackmagic ATEM	Wired for 6-ch.	40X40 video
Senn., Sony	GV Karrera, 2M/E	8-ch. EVS XT3	Evertz Xenon (64x96 HD), GV Xenon (128x128 analog)
Senn., A-T, Sony	GV Kayenne, 4M/E	2 6-ch. EVS XT2+, 2 4-ch. RO XT2+, 4-ch. SpotBox, XFile3; HDCAM, DVCPRO, DigiBeta	Evertz EQX (170x134/192x192 AES, 96x96 analog)
Senn., A-T, Sony	GV Kayenne K-Frame, 4M/E	2 6-ch. EVS XT3, 2 4-ch. RO XT3, 4-ch. SpotBox, XFile3, HDCAM, DVCPRO, DigiBeta	Evertz EQX (170x134/192x192 AES, 96x96 analog)
Senn., A-T	Ross Carbonite, 2M/E	NewTek 3Play 425; AJA Ki Pro	34x34
Senn., E-V, A-T	Ross Carbonite, 2.5M/E	1 8-ch. EVS XTnano, 1 XFile3; 1 8-ch. Tightrope ZEPLAY	Ross NK-3G72 scalable (72x72 3G HD/SD-SDI), Ross NK-A64-HQ stereo analog audio
Senn., E-V, A-T	Ross Carbonite, 2.5M/E	1 8-ch. Abekas Mira	Ross Ultrix (64x64, 128-bit MADI audio integration, core mux/demux)
Senn., E-V, A-T	Ross Carbonite Black, 3M/E	1 8-ch. EVS XTnano, 1 XFile3; 1 8-ch. Abekas Mira	Ross NK-3G72 scalable (72x72 3G HD/SD-SDI), Ross NK-D64-110 AES/EBU digital audio
Senn., E-V, A-T	Ross Carbonite Black, 3M/E	1 8-ch. EVS XTnano, 1 6-ch. XTnano, 1 XFile3	Ross Carbonite Xtreme (144x144 3G HD/SD SDI/ASI), 1 Ross NK-A64-HQ stereo analog audio
Senn., E-V, A-T	Ross Carbonite Black, 3M/E	1 8-ch. EVS XTnano, 1 6-ch. XTnano, 1 XFile3	Ross Carbonite Xtreme (144x144 3G HD/SD SDI/ASI), Ross NK-A64-HQ stereo analog audio
Senn., Sony	Sony DVS 7350, 3.5M/E	EVS XT; 6 BVW-D75, DWW-500, Doremi	Sony DVS (64x64 SDI), PESA Cougar (32x32 analog)



# HD Production Mobiles **anywhere** you need them

Proshow Broadcast provides a fleet of agile HD mobile production trucks throughout the US and Canada.

In addition to two 40' traditional production units, we offer trucks specifically designed for the growing "At-Home" and "REMI" production models.

Learn more about our fleet at [www.proshow.tv](http://www.proshow.tv)



Los Angeles

[inquiry@proshow.tv](mailto:inquiry@proshow.tv)  
1-888-776-7469

Vancouver



**AFFORDABLE HI-DEF MOBILE PRODUCTION**



918-925-9877 Oklahoma  
630-385-6213 Chicago  
info@kodiakmobile.tv

**Kodiak Mobile Television, LLC**  
1100 E. Houston Street  
Broken Arrow, OK 74012

 Kodiak-Mobile-Television-LLC  
 @kodiakmobile  
[www.kodiakmobile.tv](http://www.kodiakmobile.tv)



Proud member of  **Alliance**  
PRODUCTIONS

COMPANY	TRUCK NAME	DIMENSIONS/ TYPE	SD/HD/1080P/ 4K-CAPABLE	TRIAx, FIBER, OR BOTH?	AUDIO CONSOLE (FADERS/CHANNELS)	# CAMERAS & MAKE	LENSES (H/HH)	GRAPHICS
SDTV	HDLA	40' combo/ expando	HD/1080p	Both	Calrec Zeta (56)	8 Sony	10 Canon, 2 Fujinon	ChyronHego Duet HyperX3
	HD Link	32' combo	HD/SD	Both	Yamaha 02R96 (24)	4 Sony	2 Canon	N/A
TNDV TELEVISION	Exclamation	53' double expando	HD/1080p/4K	Fiber	Studer Vista X (60/256)	20 Hitachi SK-HD1300	Fujinon, according to specifications	ChyronHego HyperX3, Ross XPression, Avid Deko
	Aspiration	40' expando	HD	Fiber	Soundcraft VI3000 (32/96)	12 Hitachi SK-HD1000	Fujinon, according to specifications	ChyronHego HyperX3, Ross XPression, Avid Deko
	Elevation	40'	HD	Fiber	Soundcraft VI3000 (32/96)	10 Hitachi Z-HD5000	Fujinon, according to specifications	ChyronHego HyperX3, Ross XPression, Avid Deko
	Inspiration	40'	HD	Fiber	Soundcraft VI3000 (32/96)	10 Hitachi Z-HD5000	Fujinon, according to specifications	ChyronHego HyperX3, Ross XPression, Avid Deko
	Vibration	53'	HD	Fiber	Studer Vista 9 (60/384)	8 Hitachi Z-HD5000	Fujinon, according to specifications	ChyronHego HyperX3, Ross XPression, Avid Deko
	Constellation	24' Ku-band uplink hybrid	HD	Fiber	Soundcraft SI Expression 1 - 64 input channels, 16 fader	4 Hitachi Z-HD5000	Fujinon, according to specifications	ChyronHego HyperX3, Ross XPression, Avid Deko
	Origination	26'	HD	Fiber	Soundcraft Vi1 (16/64)	8 Hitachi Z-HD5000	Fujinon, according to specifications	ChyronHego HyperX3, Ross XPression, Avid Deko
	Black Jack	40'	HD	Fiber	Mackie Onyx 24/4 (24/32)	4 Hitachi Z-HD5000	Fujinon, according to specifications	ChyronHego HyperX3, Ross XPression, Avid Deko
TOKEN CREEK	Chippewa	53' expando	HD	Triax	Calrec Artemis (64 faders)	10 GV LDK 8000	6 hard/5 HH	ChyronHego HyperX3
	Sioux	53' expando	HD	Triax	Calrec Artemis (40 faders)	6 GV LDX 80	5 hard/5 HH	ChyronHego HyperX3
	Varsity	53' expando	HD	Triax	Calrec Sigma w/ Bluefin (56 faders)	10 GV LDK 8000	6 hard/4 HH	ChyronHego HyperX3
	Pioneer	53' expando	HD	Triax	Calrec Artemis	10 GV LDX80	5 hard/4 HH	ChyronHego HyperX3
21 LAKES MEDIA GROUP		40' expando	HD		Yamaha PM5000	8 GV LDK 8000		ChyronHego Duet HyperX3
VIDEOLINES MOBILE TV	HD-1	53'	HD	Triax	Yamaha M7CL-48	Ikegami 79E	2 76X, 2 66X, 2 20X	ChyronHego HyperX3
	HD-2	53'	HD	Fiber	Yamaha 2000	Ikegami 77EX	4 55X, 2 18X	ChyronHego HyperX2
	HD-3	16' box	HD	Fiber	Yamaha 16 CH	Ikegami 77EX	2 55X, 2 18X	ChyronHego HyperX2
YES	HD1	53' expando	HD	Both	Calrec Sigma w/ Bluefin (64/96)	10 Ikegami HDK 79 EC	Fujinon hard: 2 101X, 4 87X; HH: 3 22X, 1 4.5	ChyronHego HyperX3
	HD2	53' expando	HD	Both	Calrec Omega w/ Bluefin (56/48)	10 Ikegami HDK 79 EX	Fujinon hard: 1 101X, 5 87X; HH: 3 22X, 1 4.5	ChyronHego HyperX3

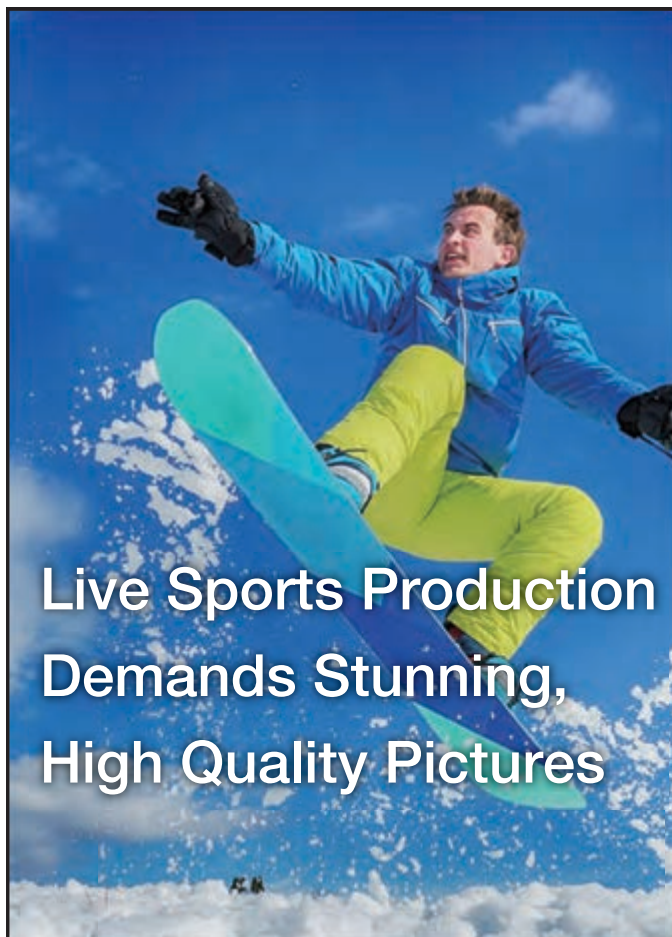

Live Sports Production  
Demands Stunning,  
High Quality Pictures

**FOR.A**<sup>®</sup>  
www.for-a.com

**MULTI CHANNEL SIGNAL PROCESSOR  
FA-505** 5 processors in one box

4K HD HDR WCG



- Registration of Log Gamma curves for HDR (High Dynamic Range) processing
- Conforms to ITU-R BT.2020 WCG(Wide Color Gamut) specifications
- 5 input/output (HD) or 1 input/output (UHD) mode
- UHD 2SI signal support
- 2x, 1/2x frame rate converter (29.97p to 59.94p, 50p to 25p, etc.).
- Low frame rate (23.98p, 30p) 4K camera signal support
- Various video functions: Frame syncs, Color correctors, Proc Amp, Clip function, Clean switch, Delay control, etc.
- Various audio functions: Gain adjustment, SRC, Delay control, Channel swap, Down mixing, etc.
- Web control GUI



MICROPHONES	SWITCHER, M/E	NUMBER REPLAY DEVICES	ROUTER (VIDEO/AUDIO SIZE)
Senn., Sony	GV Kayenne K-Frame, 4M/E	2 6-ch. EVS LSM XT3, 1 4-ch. XS SpotBox, 1 XFile3; 2 HDW-S2000, 1 PDW1500, 1 XDCAM, 1 DVCPRO	GV NVision 8288 3-GB (252x288 HD/SD), GV NVision 7512 TDM (192x256 AES, 96x80 analog, 32x32 MADI)
Senn., Sony	Sony MFS-2000, 1.5M/E	Four open slots; multiple-format capable	PESA Cougar (32x32 HD-SDI)
A-T 8035 shotgun, A-T 898 lav, Telefunken M80 Dynamic, Studio Tech booth box	GV Kayenne K-Frame, 4M/E	3	Video 256x256, audio 320x320
A-T 8035 shotgun, A-T 898 lavs, Telefunken M80 Dynamic, Studio Tech booth box	Sony MVS-8000, 3M/E	2	Video 128x160, audio 96x96
A-T 8035 shotgun, A-T 898 lavs, Telefunken M80 Dynamic, Studio Tech booth box	Ross Vision 3, 3M/E	1	Video 96x96, audio 96x96
A-T 8035 shotgun, A-T 898 lav, Telefunken M80 Dynamic, Studio Tech booth box	Ross Vision 2, 2M/E	1	Video 96x96, audio 96x96
A-T 8035 shotgun, A-T 898 lav, Telefunken M80 Dynamic, Studio Tech booth box	FOR-A HVS390, 2 M/E	1	Video 64x64, audio 128x128
A-T 8035 shotgun, A-T 898 lav, Telefunken M80 Dynamic, Studio Tech booth box	Sony MVS8000, 2M/E	1	Video 40x40
A-T 8035 shotgun, A-T 898 lav, Telefunken M80 Dynamic, Studio Tech booth box	Ross Carbonite, 2M/E	1	Video 64x64, audio 64x64
A-T 8035 shotgun, A-T 898 lav, Telefunken M80 Dynamic, Studio Tech booth box	Ross Carbonite, 3M/E	1	Video 40x40
As requested	GV Kayenne, 4.5M/E	1 6-ch. EVS LSM XT3, 1 8-ch. LSM XT3, 1 4-ch. RO XT3, SpotBox XS3; 2 AJA Ki Pro, HDCAM, 2 DVCPRO	PESA 256X (128x256 HD-SDI), PESA DRS (128x128 analog, 384x384 AES, 256x256 MADI, 256x256 embedded)
As requested	GV Karrera, 3M/E	2 6-ch. EVS LSM XT3, 1 4-ch. RO XT3; 2 AJA Ki Pro, HDCAM, DVCPRO	PESA 256X (128x256 HD-SDI), PESA DRS (128x128 analog, 256x256 AES, 256x256 MADI, 256x256 embedded)
As requested	GV Kayenne, 4M/E	2 6-ch. EVS LSM XT3, 1 4-ch. RO XT2, 4-ch. SpotBox; HDCAM, 2 DVCPRO	PESA (192x288 HD/256x256 analog, 256x256 AES)
As requested	GV Kayenne	1 6-ch. EVS LSM XT3; 1 GV Dyno; 2 AJA Ki Pro; HDCAM, 2 DVCPRO	GV Trinx
	GV Kalypso, 4M/E	1 6-ch. EVS XT2, 1 4-ch. XT2	
8 shotgun, 4 stick	GV Kayak, 4M/E	3 EVS	32X23 video/2-ch. audio
8 shotgun, 4 stick	GV Kayak, 2M/E	2 Tightrope ZEPLAY	32X23 video/2-ch. audio
4 shotgun, 4 stick	Blackmagic ATEM, 1M/E	1 NewTek 3Play	16X16 video
Standard audio	GV Kayenne, K-Frame	2 6-ch. EVS LSM XT2, 2 RO XT2, 4-ch. XS SpotBox, XFile3; HDCAM, DVCPRO HD, DigiBeta, FFV	Video 128x128 HD, 256x128 SD; audio 128x128 analog, 128x128 AES
Standard audio	GV Kalypso Duo	6-ch. EVS LSM XT2, 4-ch. XT2, 2 RO XT2, 4-ch. XS SpotBox, XFile3; HDCAM, DVCPRO HD, DigiBeta, FFV	video HD 256x128/audio analog 128x128 AES 128x128

# SPORTS BROADCASTING FUND

**SUPPORTING OUR OWN IN TIMES OF NEED...**

*The sports-television industry is a family of talent, creatives, techs, and crew who depend on each other in the studio and the field and now, with the SVG Sports Broadcasting Fund, at home. In a business underpinned by a freelance workforce, it is especially important that we develop a process for helping out our peers and their families when they are struck by serious misfortune.*



— Ken Aagaard, SVG Broadcasting Fund Advisory Board chairman



To make a donation to the Sports Broadcasting Fund, mail checks to:

**SVG Sports Broadcasting Fund** Bryant Bank,  
Attn: Heike Harris 1550 McFarland Boulevard N.,  
Tuscaloosa, AL 35406

[sportsbroadcastingfund.org](http://sportsbroadcastingfund.org)

# Anywhere, Anytime



For more than 30 years, PSSIGlobal Services has delivered the best in satellite transmission, television production and event management services to clients around the world. Backed by our skilled team of 47 broadcast engineers and 15 project managers, we proudly offer...

- 45 C-Band and Ku-Band Satellite Uplink Trucks
- 200 MPEG 2 and MPEG 4 HD Encoding Systems
- 5 Flyaway Systems
- 10-Path "At-Home" Productions
- 4K Transmission
- Exceptional Rates as an Intelsat SSP

UPLINKS | 4K | CONNECTIVITY | MULTIPATH | ENGINEERING

PSSIGLOBAL.COM | 1-800-SATLINK

# BRINGING YOUR BROADCAST VISION TO LIFE

**unity**   
systems  
integration

LEADERS IN 4K INTEGRATION

## UNITY SERVICES:

- PROJECT MANAGEMENT
- SYSTEMS DESIGN
- EQUIPMENT PROCUREMENT
- LOGISTICS SUPPORT
- INSTALLATION
- TEST AND COMMISSIONING

[unity-si.com](http://unity-si.com)



## Over Twenty Years Of Getting It Done Right



For over twenty years, Metrovision has been providing clients a full spectrum of Mobile production, Mobile Satellite Transmission and Live Event Production across North America.

### Mobile Production Services

We offer the industry's leading selection of mid-size HD OB Units for:

- Pre/Post Game Coverage
- Full Game Coverage
- Host/Unilateral Services

**Contact:** [mobile@metrovision.tv](mailto:mobile@metrovision.tv)



### Mobile Satellite Services

We are one of the leading independent Providers of Satellite Transmission Services on the East Coast

- Customized end to end solutions
- 4 KU Mobile Uplink Units
- 3 CBand Mobile Uplink Units
- Point to Point Digital Microwave

**Contact:** [satdesk@metrovision.tv](mailto:satdesk@metrovision.tv)



### Live Event Production

We bring the expertise and experience necessary for the planning and management of technical support for the Sports & Sports Marketing communities.

- Press Conferences & Award shows
- Victory parade coverage
- Pre/Post game & Wraparound Shows

**Contact:** [production@metrovision.tv](mailto:production@metrovision.tv)



## NOW OFFERING PRODUCTION COAST TO COAST

# Now onboard **VISIONHD**

The all new Calrec Summa digital audio console with Bluefin2.

New EVS XT3 Channel MAX LSM featuring 12 channels and LSM Connect 10" Tablets plus new XFile3 and much more.



 **JONESMOBILE**  
TELEVISION

501-376-1993 [www.jmtv.com](http://www.jmtv.com)

**Kaufman Broadcast was started** with a satellite dish and a vision. For more than 30 years, we have lived that vision: Super Bowls, Stanley Cups, Final Fours and All Star Games. We have worked alongside rookies and Hall of Famers. We have seen triumphs and tragedies unfold without ever having a seat. We have made visions reality.

We can capture your vision too.



TRANSMISSION / UPLINK / FIBER / ENCODING  
ENGINEERING / SYSTEMS INTEGRATION / STUDIOS

# LARGER THAN LIFE



# ... and slower, too!



When you're working the biggest shows, and you want the biggest image, along with the best in slow motion replays, remember that Lyon Video, with our fleet of 4K-native Universe cameras, as well as Extreme Motion super slo-mo packages, can give you more of everything... for less than you would believe. Go BIG! Go Lyon!

SVG SPONSOR	PAGE	LEVEL	CONTACT	EMAIL	PHONE
3G WIRELESS	233	Mobile	Gordon Capaccio	GordonC@3gwireless.tv	410-969-3501
ADOBE SYSTEMS	24	Premier	Anne Renehan	renehan@adobe.com	206-675-7476
ADORAMA	36	Corporate	Abby Hessney	abigailh@adorama.com	212-741-0401
AERIAL VIDEO SYSTEMS	224	Mobile	Argyle Nelson	argyle@aerialvideo.com	818-954-8842
AERNOW	225	Mobile	Darcy Lorincz	dlorincz@aernow.com	480-384-0898
AJA VIDEO SYSTEMS	25	Premier	Christina Oliver	christinao@aja.com	530-271-3326
AJT SYSTEMS	49	Premier	Ronald Linares	rlinares@ajtsystems.com	954-776-4591
AKAMAI	7	Platinum	Mark Ramberg	Mark.Ramberg@akamai.com	206-674-5926
ALDEA SOLUTIONS	65	Corporate	Larry Tonon	larry.tonon@aldea.tv	514-461-4136
ALL MOBILE VIDEO	243	Mobile	Eric Duke	eduke@amvchelsea.com	212-727-9862
ALLIANCE PRODUCTIONS	252	Platinum	Craig Farrell	craig@allianceproductions.com	501-219-2653
ALPHA VIDEO	196	Mobile	Jeff Volk	jeff.volk@alphavideo.com	952-841-3311
ANIXTER, INC.		Corporate	Jon Roberts	jon.roberts@anixter.com	310-795-2600
APM MUSIC	92	Corporate	Sharon Jennings	Sjennings@apmmusic.com	323-461-3211 x136
ARTEL VIDEO SYSTEMS	37	Premier	Joanne Pederson	sales@artel.com	978-263-5775
ARVATO SYSTEMS	134	Corporate	Eivind Sandstrand	esandstrand@arvatosystems.com	360 567-8465
ASPERA, AN IBM COMPANY	39	Premier	Francois Quereuil	francoisq@us.ibm.com	510-849-2386 x207
ASTUCEMEDIA	130	Corporate	Alex Leclerc	alex@astucemedia.com	514-903-6159
AT&T	2	Platinum	Scott Beckett	sb9485@att.com	214-647-0486
ATEME	71	Corporate	Daniel Morgan	d.morgan@ateme.com	615-426-3402
AUDIO-TECHNICA	123	Corporate	David Marsh	dmarsh@atus.com	330-686-2600
AV DESIGN SERVICES	218	Mobile	Jim Landy	jmlandy@avds.tv	609-531-2642
AVECO	40	Premier	Jim O'Brien	jim.obrien@aveco.com	818-292-1489
AVID	33	Premier	Doug Price	doug.price@avid.com	817-239-9626
AZZURRO GROUP	235	Mobile	Mark Lowden	mlowden@azzurrogroup.com	212-625-2372
BARNFIND AMERICAS	93	Premier	John McCluskey	john.mccluskey@barnfindamericas.com	888-491-6903
BAY MICROSYSTEMS		Corporate	Russel Davis	rdavis@baymicrosystems.com	408-841-4738
BECKTV	179	Mobile	Fred Wright	fwright@becktv.com	972-505-8941
BEXEL	20	Platinum	Craig Schiller	cschiller@bexel.com	818-565-4202
BIOGFX - POWERED BY FM PRODUCTIONS	109	Corporate	Alon Cohen	Alon@fightmetric.com	571-766-6631
BITCENTRAL	29	Corporate	Ron Rosenthal	rrosenthal@bitcentral.com	949-417-4190
BLACK BOX	117	Corporate	Bill Frazier	bill.frazier@blackbox.com	724-873-6557
BLACKMAGIC DESIGN	23	Platinum	Bob Caniglia	bobc@blackmagicdesign.com	408-954-0500 x319
BLUE FRAME TECHNOLOGY		Corporate	Darren Brown	darren@blueframetech.com	859-619-4288
BRAINSTORM	100	Corporate	Brad Rumler	brumler@brainstorm3d.com	201-888-9599
BRAND BRIGADE	131	Corporate	Samuel Chenillo	schenillo@brandbrigade.com	212-265-0205
BROAMAN	141	Corporate	Florian Myrus	f.myrus@broaman.com	[49] 89 8999 640
BROCADE	170	Corporate	Sam Scheffler	sscheffl@brocade.com	551-427-3537
BSI (BROADCAST SERVICES INTERNATIONAL)	221	Mobile	Jim Eady	jim@bsi-tv.com	905-332-2171
BSI (BROADCAST SPORTS INTERNATIONAL)	171	Corporate	Jeremy Pink	jeremy.pink@bsintl.com	410-564-2621
BURST	237	Corporate	Paul Levy	paul@burst.com	617-977-9500



SVG SPONSOR	PAGE	LEVEL	CONTACT	EMAIL	PHONE
CALHOUN SATELLITE COMMUNICATION		Mobile	Kevin Husband	k.husband@calhounsat.com	305-655-2629
CALIENT TECHNOLOGIES	226	Mobile	Shannon Carr	scarr@calient.net	714-350-1020
CALREC AUDIO/DIGICO (GROUP ONE)	8	Platinum	Jack Kelly	jackk@glimited.com	631-396-0184 x102
CANARE CORPORATION OF AMERICA	108	Corporate	Joe Castellano	jcastellano@canare.com	973-837-0070
CANON	13	Platinum	TV Production Sales	cinemaeos@cits.canon.com	800-423-5367
CAT ENTERTAINMENT SERVICES	248	Mobile	Phil Wessels	phil.wessels@ringpower.com	904-494-7550
CBT SYSTEMS	229	Mobile	Darrell Wenhardt	darrell@cbt-net.com	858-536-2927
CHESAPEAKE SYSTEMS	209	Mobile	Nick Gold	nick@chesa.com	410-400-8932
CHRISTIE DIGITAL	32	Premier	Virginia Dwyer	virginia.dwyer@christiedigital.com	519-749-3176
CHYRONHEGO	45	Premier	Jesper Gawell	jesper.gawell@chyronhego.com	646-469-2272
CINESYS-OCEANA	223	Mobile	Brent Angle	brent.angle@cinesysinc.com	713-272-0732
CISCO	41	Premier	Michael Caponigro	mcaponig@cisco.com	408-527-6111
CLARK MEDIA	293	Mobile	Gary Snyder	garys@clarkmedia.com	610-694-9800
CLEAR-COM - AN HME COMPANY	43	Premier	Bradley Kellogg	Bradley.Kellogg@Clearcom.com	510-337-6601
CLICK EFFECTS, A CHYRONHEGO COMPANY	44	Premier	Scott Sheppard	ssheppard@clিকেffects.com	615-460-7330 x113
CMG MOBILE PRODUCTIONS		Mobile	Bill Coffell	bill@cmgmobile.com	847-924-2254
COBALT DIGITAL	101	Premier	Bob McAlpine	Bob.McAlpine@cobaltdigital.com	217-531-0165
COMMUNICATIONS ENGINEERING INC. (CEI)	211	Mobile	James Baldwin	sales@commeng.com	703-550-5800
COMREX CORPORATION	143	Corporate	Chris Crump	ccrump@comrex.com	978-784-1776
CP COMMUNICATIONS	253	Mobile	Kurt Heitmann	kurt.heitmann@cpcomms.com	914-345-9292
CRAWFORD MEDIA SERVICES	202	Corporate	Emily Halevy	ehalevy@crawford.com	678-536-4871
CREATIVE MOBILE SOLUTIONS	215	Mobile	Noah Gusdorff	noah@cmsi.tv	818-847-7390
CROWN CASTLE	137	Corporate	Erika Lambert	Erika.Lambert@crowncastle.com	724-743-6379
CSP MOBILE	245	Mobile	Len Chase	len@cspmobile.com	207-282-9680
CTG (COMPREHENSIVE TECHNICAL GROUP)	188	Mobile	Jim Lee	Jlee@ctgatlanta.com	678-387-5507
DAKTRONICS	153	Corporate	Sales	sales@daktronics.com	800-325-8766
DALE PRO AUDIO	135	Corporate	Michael Descoteau	miked@daleproaudio.com	857-756-6980
DALET DIGITAL MEDIA SYSTEMS	140	Corporate	Eric Carson	ecarson@dalet.com	918-327-9171
DDN STORAGE	180	Corporate	Laura Thommen	lthommen@ddn.com	818-451-9301
DELL EMC	139	Corporate	Jeff Grassinger	Jeff.Grassinger@dell.com	206-315-7598
DELTATRE	174	Corporate	Carlo De Marchis	carlo.demarchis@deltatre.com	[39] 011 384 18344
DELUXE	294	Corporate	Derek Hildebrandt	derek.hildebrandt@bydeluxe.com	818-525-4126
DEVLIN DESIGN GROUP	85	Premier	Dan Devlin	ddevlin@ddgtv.com	970-349-5836
DIGICASTER/DIGITAL COMM LINK	236	Mobile	Said Khan	SKhan@dclinc.net	954-236-2993
DIVERSIFIED	183	Mobile	Duane Yoslov	dyoslov@diversifiedus.com	408-969-1972
DNA STUDIOS	257	Mobile	Sam Schrade	sam@dnawebs.com	281-802-8000
DOLBY	16	Platinum	Cherylene McKinney	cherylene.mckinney@dolby.com	646-823-1523
DOMA PRODUCTIONS	239	Mobile	Mary Ellen Carlyle	mcarlyle@domeprod.com	416-341-2022
DPA MICROPHONES		Corporate	Christoper Spahr	csp@dpamicrophones.com	914-582-4399

SVG SPONSOR	PAGE	LEVEL	CONTACT	EMAIL	PHONE
DUNCAN VIDEO		Mobile	Jon Bereman	jbereman@duncanvid.com	317-815-6300
DX3 MEDIA INC.		Mobile	Dale Smith	dalesmith@DX3media.ca	416-433-3261
EEG ENTERPRISES	58	Corporate	Eric McErlain	ericm@eegent.com	516-293-7472 x502
ELEMENTAL TECHNOLOGIES	48	Premier	Henry Canizares	henry.canizares@elementaltechnologies.com	971-270-0320
ENCOMPASS DIGITAL MEDIA	67	Corporate	Chris Gagliano	cgagliano@encompass.tv	917-921-3782
ERICSSON	84	Premier	Dan Burnett	daniel.burnett@ericsson.com	678-689-6535
EUROVISION	15	Platinum	Jim Scott	jim.scott@eurovision.net	973-650-9577
EVERTZ	57	Premier	Joe Cirincione	joe@evertz.com	818-558-3910
EVS	52	Premier	James Stellpflug	j.stellpflug@evs.com	973-575-2140
F&F PRODUCTIONS	256	Mobile	George Orgera	GeorgeO@fandfhd.tv	727-535-6776
FANCONNECT	165	Corporate	Larry Witherspoon	larry@fan-connect.com	704-837-7099
FILECATALYST	31	Premier	Alan Atkinson	aatkinson@filecatalyst.com	613-667-2439 x116
FILMTRACK		Corporate	Jennifer Sistilli	jennifer.sistilli@filmtrack.com	818-766-2607
FILMWERKS INTERNATIONAL	261	Mobile	Michael Satrazemis	michaels@filmwerksintl.com	910-675-1145
FIS BLUE	161	Corporate	Derek Curtis	dcurtis@fisblue.com	315-768-8179
FLETCHER SPORTS	53	Corporate	Dan Grainge	dan@fletch.com	312-932-2704
FLORICAL SYSTEMS	129	Corporate	Shawn Maynard	shawn.maynard@florical.com	352-372-8326
FOR-A	87, 278	Corporate	Jay Shinn	shinn@for-a.com	201-668-1122
FORSCENE	125	Corporate	Jem Parks	jem.parks@forscene.com	[44] 330 380 1130
FRAUNHOFER	115	Corporate	Robert Bleidt	robert.bleidt@dmf.fraunhofer.org	408-573-9901
FUJIFILM	19	Platinum	Gordon Tubbs	gtubbs@fujifilm.com	973-686-2769
FX DESIGN GROUP	148	Corporate	Mack McLaughlin	mmclaughlin@fxgroup.tv	407-877-9600
GAME CREEK VIDEO	260	Mobile	Pat Sullivan	sullgame@aol.com	603-821-2205
GEARHOUSE BROADCAST	269	Mobile	Marc Genin	mgenin@gearhousebroadcast.com	818-955-9449
GERLING & ASSOCIATES	242	Corporate	Fred Gerling	fredg@gerlinggroup.com	740-965-2888
GLOBECAST	191	Corporate	Eddie Ferraro	eddie.ferraro@globecast.com	212-373-5144
GRASS VALLEY, A BELDEN BRAND	9	Platinum	Steve Stubelt	stephen.stubelt@grassvalley.com	862-216-7070
HAIVISION	181	Corporate	Karen McCone	kmccone@haivision.com	514-993-2683
HARMAN	21, 87	Premier	Katy Templeman-Holmes	Katy.Templeman-Holmes@harman.com	818-920-3295
HARMONIC	97	Premier	Bill Cordo	bill.cordo@harmonicinc.com	201-669-0890
HGST/G-TECHNOLOGY	4	Platinum	Jeff Greenwald	jeff.greenwald@hgst.com	408-573-5104
HITACHI KOKUSAI	99	Corporate	Sean Moran	sean.moran@hitachikokusai.us	516-682-4431
IBM CLOUD VIDEO	147	Corporate	Kyle Cowan	kmcowan@us.ibm.com	818-472-1510
IHSE USA	107	Premier	Dan Holland	dholland@ihseusa.com	732-738-8780
IKEGAMI	111	Premier	Teri Zastrow	tzastrow@ikegami.com	201-368-9171
ILLUMINATION DYNAMICS	265	Mobile	Rich Williams	rich@illuminationdynamics.com	818-686-6400
IMAGE VIDEO	230	Corporate	Zach Wilkie	zwilkie@imagevideo.com	416-750-8872 x228
IMAGEN	149	Corporate	Ian Mottashed	ian.mottashed@imagenvp.com	[44] 1954 262004
IMAGINE COMMUNICATIONS	54	Premier	Peter Tsegaye	peter.tsegaye@imaginecommunications.com	647-772-4013
IMS PRODUCTIONS	264	Mobile	Robby Greene	rgreene@imsptv.com	317-492-8710
INERTIA UNLIMITED	61	Premier	Jeff Silverman	jeff@inertiaunlimited.com	802-368-2591

SVG SPONSOR	PAGE	LEVEL	CONTACT	EMAIL	PHONE
INTEGRATED MEDIA TECHNOLOGIES	194	Mobile	Tom McGowan	tom.mcgowan@imglobalinc.com	818-761-9770
INTERXION	199	Corporate	Richard Craig-McFeely	richardc@interxion.com	[44] 07342 949663
IRDETO	144	Corporate	John Branigan	john.branigan@irdeto.com	818-508-2333
ISTREAMPLANET	157	Corporate	Tim Davis	timd@istreamplanet.com	702-492-5900
JB&A	231	Corporate	Jeremy Strootman	jeremys@jbanda.com	314-229-6012
JONES MOBILE TELEVISION	283	Mobile	Bob Derryberry	bobd@jmtv.com	501-376-1993
JOSEPH ELECTRONICS	91	Premier	Yohay Hahamy	yohay@josephelectronics.com	847-501-1584
JVCKENWOOD	119	Premier	Craig Yanagi	cyanagi@us.jvckenwood.com	973-317-5176
KAUFMAN BROADCAST	284	Mobile	Bill Kaufman	bill.kaufman@kaufmanbroadcast.com	314-533-6633
KMH AUDIO-VIDEO INTEGRATION	238	Mobile	Kevin Henneman	khenneman@kmh-integration.com	800-590-2520
KODIAK MOBILE TELEVISION	277	Mobile	David Kearnes	david@kodiakmobile.tv	918-925-9877
LAWO	C4	Platinum	Don Bird	don.bird@lawo.us	818-292-2541
LEADER INSTRUMENTS	120	Corporate	Scott Cannon	cannon@leaderamerica.com	800-645-5104
LEVEL 3	12	Platinum	Cathy Rieb	cathy.rieb@level3.com	877-4LEVEL3
LEVELS BEYOND	151	Corporate	Luc Comeau	lcomeau@levelsbeyond.com	347-494-1652
LH COMPUTER SERVICES	172	Mobile	Doug Cole	dcole@lhcomp.com	954-752-5805
LIMELIGHT NETWORKS	127	Premier	Janice Merk	jmerk@llnw.com	602-850-5385
LINEAR ACOUSTIC (TELOS ALLIANCE)	79	Corporate	Chris Shaw	chris@linearacoustic.com	925-216-8846
LITTLE BAY BROADCAST SERVICES	292	Mobile	Brian Raynes	brian@littlebay.tv	603-534-5600
LIVE X	214	Corporate	Corey Behnke	corey@livex.tv	844-465-4839
LIVEU	152	Corporate	Mike Savello	mike@liveu.tv	201-742-5227
LTN GLOBAL COMMUNICATIONS	168	Corporate	Missy Gralish	mgralish@ltnglobal.com	412-996-9350
LYON VIDEO	285	Mobile	Chad Snyder	chad@lyonvideo.com	614-319-4071
MARKERTEK	83	Premier	Gregory DeCelle	greg@towerpower.com	845-246-2357
MASERGY	219	Corporate	Dan Boland	dan.boland@masergy.com	630-632-2062
MEDIA LINKS	193	Corporate	David Herfert	dherfert@medialinks.com	860-206-9163
METROVISION	282	Mobile	Jim McGillion	jim@metrovision.tv	212-989-1515
MICROSOFT	73	Premier	Scott Bounds	sbounds@microsoft.com	646-225-4380
MOBILE TV GROUP	272	Mobile	Philip Garvin	pgarvin@coloradostudios.com	303-542-5555
MOEBAM! VENUE MEDIA SERVICES	220	Corporate	Rick Price	rprice@moebam.com	407-476-9390
MPS (MOBILE PRODUCTION SERVICES)		Mobile	Eric Riley	erileymp@aol.com	614-864-7900
MULTIDYNE	59	Premier	Frank Jachetta	frank@multidyne.com	516-671-7278 x301
MX1	187	Corporate	Susanna Mandel-Mantello	susanna.mantello@mx1.com	203-661-7971
NEP BROADCASTING	240	Premier	George Hoover	george.hoover@nepinc.com	800-444-0054
NET INSIGHT	160	Corporate	Per Johansson	per.johansson@netinsight.net	703-945-3739
NEULION	47	Corporate	Dana Williams	Dana.williams@neulion.com	516-622-8301
NEUTRIK USA	116	Corporate	Janet Tufo	jtuf@neutrikusa.com	704-916-0357
NEVION	156	Corporate	Mike Root	sales@nevion.com	212-380-0550
NEWTEK	27	Platinum	Philip Nelson	pnelson@newtek.com	210-863-0360

SVG SPONSOR	PAGE	LEVEL	CONTACT	EMAIL	PHONE
NTC (NATIONAL TELECONSULTANTS)		Mobile	Steven Mendel	steven.mendel@ntc.com	818-265-3605
OOPYALA	164	Corporate	Scott Katzenoff	scottkatz@ooyala.com	516-669-0003
ORACLE	155	Corporate	Sean Killen	sean.killen@oracle.com	786-417-9358
OSI (ORGANIZATIONAL STRATEGIES, INC.)	176	Corporate	Jonathan Kelly	jkelly@orgstrategies.com	571-499-0101
PANASONIC	95	Premier	Carter Hoskins	carter.hoskins@us.panasonic.com	770-619-1779
PESA	88	Corporate	Randy Lloyd	rlloyd@pesa.com	214-856-5351
PLIANT TECHNOLOGIES	28	Corporate	Gary Rosen	Gary.Rosen@plianttechnologies.com	818-264-9730
PLUS24/SANKEN	184	Corporate	Jim Pace	jp pace@plus24.net	323-855-1404
PRG	175	Corporate	Brian Edwards	bedwards@prg.com	818-252-2630
PRIMESTREAM	132	Corporate	Robert Lisman	robertlisman@primestream.com	305-625-4415
PRODUCTIONHUB	177	Corporate	Steve Rotz	srotz@productionhub.com	877-629-4122
PROGRAM PRODUCTIONS	273	Mobile	Robert Carzoli	rcarzoli@programproductions.com	630-282-0155
PRONOLOGY	124	Corporate	Jonathan Aroesty	jaroesty@pronology.com	310-397-6900
PROSHOW	276	Mobile	Tim Lewis	timlewis@proshow.com	604-293-1771
PSSI/STRATEGIC TV	280	Mobile	Clayton Packard	cpackard@pssiglobal.com	310-575-4400
QUALCOMM		Premier	Deep Sen	dsen@qti.qualcomm.com	858-860-4185
QUANTUM	10	Platinum	Dave Frederick	dave.frederick@quantum.com	408-944-4424
QUANTUM5X	70	Corporate	Paul Johnson	pjohnson@q5x.com	519-675-6999
RAINBOW BROADBAND	190	Corporate	Joe Antine	jantine@rainbowbroadband.com	212-201-1241
RAYCOM SPORTS		Mobile	Mark Riley	mriley@raycomsports.com	704-378-4400
REALITY CHECK SYSTEMS	14	Platinum	Jeff Heimbald	j.heimbold@realitychecksystems.com	323-465-3900
RIEDEL COMMUNICATIONS	35	Platinum	Joyce Bente	joyce.bente@riedel.net	818-559-6905
ROBOVISION		Mobile	Richard Glandorf	rhglandorf@mac.com	973-879-1096
ROCK-IT CARGO	208	Corporate	Kevin Delia	kevind@rockitcargo.com	516-825-7356
ROSS VIDEO	50	Platinum	Kevin Cottam	kcottam@rossvideo.com	613-228-0688 x4366
RT SOFTWARE	189	Corporate	Ryan Lester	ryan.lester@rtsw.co.uk	[44] 20 7384 2711
SAM (SNELL ADVANCED MEDIA)	C2	Platinum	John Shike	John.Shike@s-a-m.com	650-703-4906
SAUNDERS ELECTRIC	232	Mobile	Candace Saunders	candace@saunderselectric.com	615-514-8140
SCALE LOGIC	159	Corporate	Jeff Lowe	jlowe@scalelogicinc.com	612-361-3449
SDTV		Mobile	Mark Parikka	operations@sdtv.com	619-293-7777
SENNHEISER	96	Corporate	Chris Clay	Chris.Clay@Sennheiser.Com	860-434-9190
SES	74	Premier	Richard Lamb	richard.lamb@ses.com	[31] 70 306 4211
SGL	75	Premier	Douglas Wynn	doug.wynn@sglbroadcast.com	608-345-1568
SHURE	103	Corporate	Bill Ostry	ostry_bill@shure.com	847-600-6282
SIGNIANT	201	Corporate	Jim Ball	jball@signiant.com	781-221-4028
SKYCAM/CABLECAM	63	Mobile	Endre Buxton	endre.buxton@skycam.tv	817-984-6840
SMARTCART SVX	128	Mobile	Gil Cowie	gil@smartcartsvx.com	646-863-6263
SMT	6	Platinum	Lisa Shanahan	l.shanahan@smt.com	919-493-9390
SONOVTS	227	Mobile	Franz Olbert	Franz.Olbert@sonovts.de	[49] 89 419 671 114
SONY	1	Platinum	Deon LeCointe	deon.lecointe@am.sony.com	201-930-6926
SOS GLOBAL EXPRESS	77	Premier	Fernando Soler	fsoler@sosglobal.com	800-628-6363

SVG SPONSOR	PAGE	LEVEL	CONTACT	EMAIL	PHONE
SPECTRA LOGIC	163	Corporate	Hossein ZiaShakeri	hosseinz@spectralogic.com	303-449-6444 x 1118
SPORTSTRACE		Corporate	Max Montrey	max@sportstrace.com	201-892-4961
STATS	200	Corporate	Herrman Taraporewalla	htaraporewalla@stats.com	847-728-4463
T-21 TECHNOLOGIES	213	Corporate	Kevin Ancelin	KAncelin@t-21.biz	904-673-6131
T2 COMPUTING	167	Corporate	Chris Payne	cpayne@t2computing.com	212-929-3645
TATA COMMUNICATIONS	205	Corporate	David Moore	david.moore@tatacommunications.com	704-806-6679
TECHNICOLOR	104	Corporate	Roy Stewart	roy.stewart@technicolor.com	818-260-4524
TEKTRONIX	195	Corporate	Mike Wright	mike.wright@tektronix.com	818-200-3008
TELESTREAM	62	Corporate	Scott Murray	scotty@telestream.net	530-470-1306
TERADEK	78	Premier	Andrew Ng	andrew.ng@teradek.com	888-941-2111 x130
THE STUDIO - B&H	46	Premier	The Studio Team	thestudio@bandh.com	800-947-9962
THE SWITCH	69	Premier	Christian Kneuer	christian.kneuer@theswitch.tv	212-239-3715
THINKLOGICAL	207	Corporate	Richard A. Cooper	richard.cooper@thinklogical.com	484-467-5633
TIGHTROPE MEDIA SYSTEMS	217	Corporate	Steve Israelsky	steve@trms.com	651-603-4214
TL MOBILE		Mobile	Troy Fain	troy@tlmobiletv.com	417-724-2574
TNDV TELEVISION	268	Mobile	Rob Devlin	rob@tndv.com	877-959-8638
TOKBOX	206	Corporate	Nhu-Anh Can	nhuanh@tokbox.com	408-421-9292
TOKEN CREEK	244	Mobile	John Salzwedel	john@tokencreek.com	608-849-4965
TSL PRODUCTS	121	Corporate	Amanda Dixon	amanda.dixon@tslproducts.com	[44] 1628 564610
TV GRAPHICS	66	Corporate	Dan Murphy	dantvgraphics@gmail.com	303-550-7088
TVU NETWORKS	197	Corporate	Ken Valdiserri	kvaldiserri@tvunetworks.com	650-969-6732
UNITY SYSTEMS INTEGRATION	281	Mobile	Bruce Long	Bruce.Long@unity-si.com	905-707-3801
UTAH SCIENTIFIC	113	Corporate	Chris Harmon	charmon@utahscientific.com	801-575-3233
VANTRIX	82	Premier	Kjell Kolstad	Kjell.kolstad@vantrix.com	514-613-1320
VER	18	Platinum	Howie Rosenthal	hrosenthal@verrents.com	818-956-1444
VERIZON DIGITAL MEDIA SERVICES	89	Premier	Jeff Casey	jeffrey.casey@verizon.com	908-559-2036
VISLINK		Premier	Sarah Kemp	sarah.kemp@vislink.com	[44] 1442 431300
VISTA WORLDBLINK	212	Corporate	Joshua Liemer	jliemer@vistaworldlink.com	954-838-0900 x210
VITEC	145	Premier	Geol Yeadon	geol.yeadon@vitec.com	650-230-2563
VITEC VIDEOCOM	105	Corporate	Tanya Lyon	Tanya.Lyon@vitecgroup.com	818-582-8295
VIZRT	3	Platinum	David Jorba	DJorba@vizrt.com	646-746-0038
WARNER/CHAPPELL PRODUCTION MUSIC	55	Corporate	Jennifer Stowe	jennifer.stowe@warnerchappellpm.com	615-687-6859
WAZEE DIGITAL	169	Corporate	Mike Arthur	mike.arthur@wazeedigital.com	720-318-8157
WEATHER OPS	C3	Platinum	Michael Eilts	eilts@wdtinc.com	405-413-7935
WHEATSTONE	80	Corporate	Phil Owens	philowens@wheatstone.com	252-638-7000
WOWZA MEDIA SYSTEMS	185	Corporate	Laurie Wherley	laurie.wherley@wowza.com	720-608-4414
WTVISION		Corporate	Mario Sousa	mario.sousa@wtvision.com	305-357-5893
YAMAHA CORPORATION OF AMERICA	112	Corporate	Paul Furtkamp	pfurtkamp@yamaha.com	714-522-9011
YES PRODUCTIONS	249	Mobile	Jim Moriarty	jim@yesproductions.com	504-840-4891
ZIXI	203	Corporate	Eric Bolten	eric@zixi.com	978-853-8482

# WHAT CAN LITTLE BAY DO FOR YOU?

**Little Bay Broadcast Services** is a broadcast system integration firm located in Dover, New Hampshire. We provide **design, integration, installation and consulting** for the television industry. Little Bay specializes in HDTV infrastructure and upgrades. We have designed and built state-of-the-art facilities and mobile production systems for a variety of applications including regional sports networks, large venue stadiums, broadcasters, and corporations.

**CONTACT:**

Info@littlebay.tv  
www.littlebay.tv

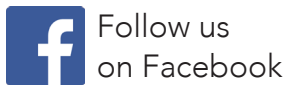

(603) 664-3255 Office



**CLARK MEDIA** 40' HD/4K Mobile Truck  
*Heads-Up Thinking™*



**Grass Valley 4ME Kayenne Switcher ■ 10 Sony HDC-2500 or HDC-4300 Fiber Cameras  
 Calrec Artemis Light Audio Board ■ Two EVS XT3 6 Channel  
 Seating for 16 comfortably ■ An entire rental house to back it up.**

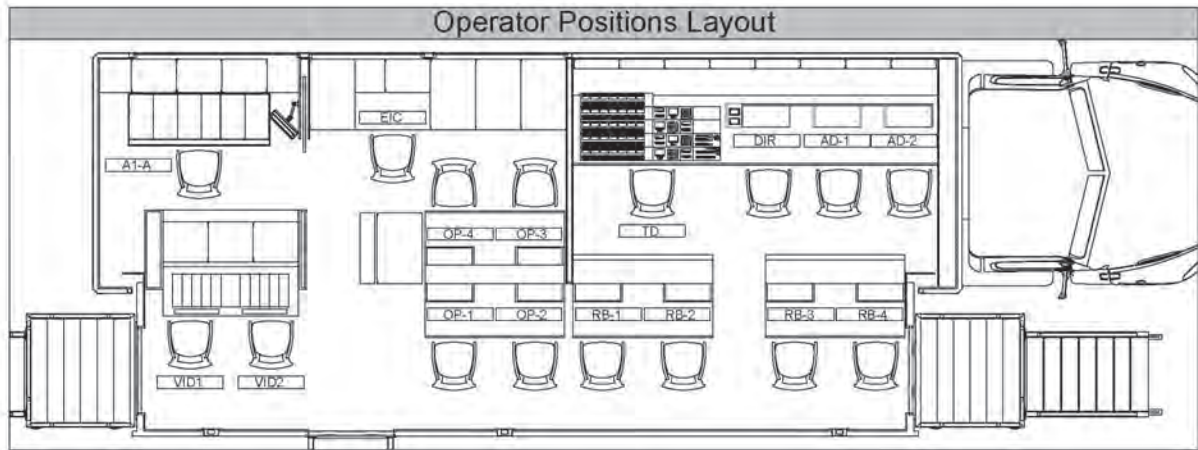

We built this truck based on the requests and feedback from our clients and crew. Designed for high quality HD and 4K production, it is compact, gets in tight spaces and sets up fast. Call Clark Media today to get a quote and put this new mobile on hold.



**East Coast: 610-694-9800**

**clarkmedia.com**

**West Coast: 818-435-4689**



# **We don't fumble. We deliver.**

Engaging fans across platforms and around the world is no easy task. Let Deluxe carry the ball for you. We've been servicing top content owners and providers for more than 100 years – from creation through delivery.

IP Delivery | Remote Production | Metadata Services | Localization | Security  
Promo Materials | Content Production | In-Game Entertainment | Virtual Reality

[bydeluxe.com](https://bydeluxe.com)  
[sports@bydeluxe.com](mailto:sports@bydeluxe.com)



# Broadcast and A/V Solutions For the Sports Venue Market

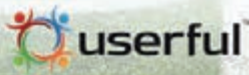

BTX Technologies is your source for Broadcast and A/V solutions used in sports arenas, stadiums, sports bars and other related venues. Our products and solutions are featured in major sports broadcasting installations around the world and include video and audio over IP, integration essentials (including cables, connectors and consumables), custom and off-the-shelf fiber and plates and panels. Our award-winning sales team is dedicated to helping you reach your project goals and requirements.





# WHEN IT COMES TO TECHNOLOGY, SPORTS TELEVISION LEADS THE WAY

We're proud to represent those professionals who enrich the fan's experience, break new barriers, and establish new standards for all forms of live television, mobile, and broadband entertainment.

SVG's advocacy, communication, education, and market development activities are made possible by the following sponsors:

## PLATINUM SPONSORS



## PREMIER SPONSORS

- ADOBE • AJA VIDEO SYSTEMS • AJT SYSTEMS • ARTEL VIDEO SYSTEMS • ASPERA, AN IBM COMPANY • AVECO • AVID • BARNFIND AMERICAS
- CHRISTIE DIGITAL • CHYRONHEGO • CISCO • CLEAR-COM - AN HME COMPANY • CLICK EFFECTS, A CHYRONHEGO COMPANY • COBALT DIGITAL
- DEVLIN DESIGN GROUP • ELEMENTAL TECHNOLOGIES • ERICSSON • EVERTZ • EVS • FILECATALYST • HARMAN • HARMONIC • IHSE USA • IKEGAMI
- IMAGINE COMMUNICATIONS • INERTIA UNLIMITED • JOSEPH ELECTRONICS • JVCKENWOOD • LIMELIGHT NETWORKS • LINEAR ACOUSTIC • MARKERTEK
- MICROSOFT • MULTIDYNE • NEP BROADCASTING • PANASONIC • QUALCOMM • SES • SGL • SOS GLOBAL • TERADEK • THE STUDIO - B&H • THE SWITCH
- VANTRIX • VERIZON DIGITAL MEDIA SERVICES • VISLINK • VITEC

## CORPORATE SPONSORS

- ADORAMA • ALDEA • ANIXTER • APM MUSIC • ARVATO SYSTEMS • ASTUCEMEDIA • ATEME • AUDIO-TECHNICA • BAY MICROSYSTEMS
- BIOGFX POWERED BY FM PRODUCTION • BITCENTRAL • BLACK BOX • BLUEFRAME TECHNOLOGY • BRAINSTORM • BRAND BRIGADE
- BROAMAN • BROCADE • BSI (BROADCAST SPORTS INTERNATIONAL) • BURST • CANARE CORPORATION OF AMERICA • COMREX CORPORATION
- CRAWFORD MEDIA SERVICES • CROWN CASTLE • DAKTRONICS • DALE PRO AUDIO • DALET DIGITAL MEDIA SYSTEMS • DELL EMC • DELTATRE
- DELUXE • DPA MICROPHONES • EEG ENTERPRISES • ENCOMPASS DIGITAL MEDIA • FANCONNECT • FILMTRACK • FIS BLUE • FLETCHER SPORTS • FLORICAL SYSTEMS
- FOR-A • FORSCENE • FRAUNHOFER • FX DESIGN GROUP • GERLING & ASSOCIATES • GLOBECAST • HAIVISION • HITACHI KOKUSAI • IBM CLOUD VIDEO • IMAGE VIDEO
- IMAGEN • INTERXION • IRDETO • ISTREAMPLANET • JB&A • LEADER INSTRUMENTS • LEVELS BEYOND • LIVE X • LIVEU • LTN GLOBAL • MASERGY • MEDIA LINKS
- MOEBAMI VENUE MEDIA SERVICES • MX1 • NET INSIGHT • NEULION • NEUTRIK USA • NEVION • OYALA • ORACLE • PESA • PLIANT TECHNOLOGIES • PLUS24/SANKEN
- PRG • PRIMESTREAM • PRODUCTIONHUB • PRONOLGY • QUANTUM5X • RAINBOW BROADBAND • ROCK-IT CARGO • RT SOFTWARE • SCALE LOGIC • SENNHEISER
- SHURE • SIGNIANT • SPECTRA LOGIC • SPORTSTRACE • STATS • T-21 TECHNOLOGIES • T2 COMPUTING • TATA COMMUNICATIONS • TECHNICOLOR • TEKTRONIX
- TELESTREAM • THINKLOGICAL • TIGHTROPE MEDIA SYSTEMS • TOKBOX • TSL PRODUCTS • TV GRAPHICS • TVU NETWORKS • UTAH SCIENTIFIC • VISTA WORLDBLINK
- VITEC VIDEOCOM • WARNER/CHAPPELL PRODUCTION MUSIC • WAZEE DIGITAL • WHEATSTONE • WOWZA MEDIA SYSTEMS • WTVISION
- YAMAHA CORPORATION OF AMERICA • ZIXI

## MOBILE/INTEGRATOR SPONSORS

- 3G WIRELESS • AERIAL VIDEO SYSTEMS • AERNOW • ALL MOBILE VIDEO • ALPHA VIDEO • AV DESIGN SERVICES • AZZURRO GROUP • BECKTV
- BSI (BROADCAST SERVICES INTERNATIONAL) • CALHOUN SATELLITE COMMUNICATIONS • CALIENT TECHNOLOGIES • CAT ENTERTAINMENT SERVICES
- CBT SYSTEMS • CHESAPEAKE SYSTEMS • CINESYS-OCEANA • CLARK MEDIA • CMG MOBILE PRODUCTIONS • COMMUNICATIONS ENGINEERING INC. (CEI)
- CP COMMUNICATIONS • CREATIVE MOBILE SOLUTIONS • CSP MOBILE • CTG • DIGICASTER/DIGITAL COMM LINK • DIVERSIFIED • DNA STUDIOS
- DOME PRODUCTIONS • DUNCAN VIDEO • DX3 MEDIA GROUP INC. • F&F PRODUCTIONS • FILMWERKS INTERNATIONAL • GAME CREEK VIDEO
- GEARHOUSE BROADCAST • ILLUMINATION DYNAMICS • IMS PRODUCTIONS • INTEGRATED MEDIA TECHNOLOGIES • JONES MOBILE TELEVISION
- KAUFMAN BROADCAST • KMH AUDIO-VISUAL INTEGRATION • KODIAK MOBILE • LH COMPUTER SERVICES • LITTLE BAY BROADCAST SERVICES • LYON VIDEO
- METROVISION • MOBILE TV GROUP • MPS (MOBILE PRODUCTION SERVICES) • NATIONAL TELECONSULTANTS • PROGRAM PRODUCTIONS • PROSHOW
- PSSI/STRATEGIC TV • RAYCOM • ROBOVISION • SAUNDERS ELECTRIC • SDTV • SKYCAM/CABLECAM • SMARTCART SVX • SONOVTS • TL MOBILE • TNDV • TOKEN CREEK
- UNITY SYSTEMS INTEGRATION • YES PRODUCTIONS

ADVANCING THE CREATION, PRODUCTION, & DISTRIBUTION OF SPORTS CONTENT

# WWW.SPORTSVIDEO.ORG

# BRINGING WEATHER SAFETY CENTER STAGE



## Outdoor Venue Safety It's time to make weather a priority

At one point or another you have and will experience a disruption at your venue due to weather. The severity of a given situation is always an unknown unless you have meteorological support. This support generally comes at a high cost but we've built a business model to provide the support you need at a price that's affordable. Be a hero to fans, staff, and stakeholders by being in the know before a contingency plan needs to be executed. Plan, position and protect with WeatherOps decision support services starting at \$195.

WeatherOps.com | Call 844.994.2278

NETWORK. AUDIO. VIDEO. CONTROL.



# Pushing the Envelope.

Watch it on YouTube.  
[tinyurl.com/lawo-pte](http://tinyurl.com/lawo-pte)



Official MotoGP™ Supplier  
Audio/Video-over-IP Infrastructure

[www.lawo.com](http://www.lawo.com)